

The PuTex[®] Pultrusion Design Manual

STANDARD AND CUSTOM FIBER REINFORCED POLYMER STRUCTURAL PROFILES

VOLUME 5 - REVISION 15 | IMPERIAL VERSION

FEATURING

- PuTex Standard Structural Profiles
- PuTex SuperStructural Profiles

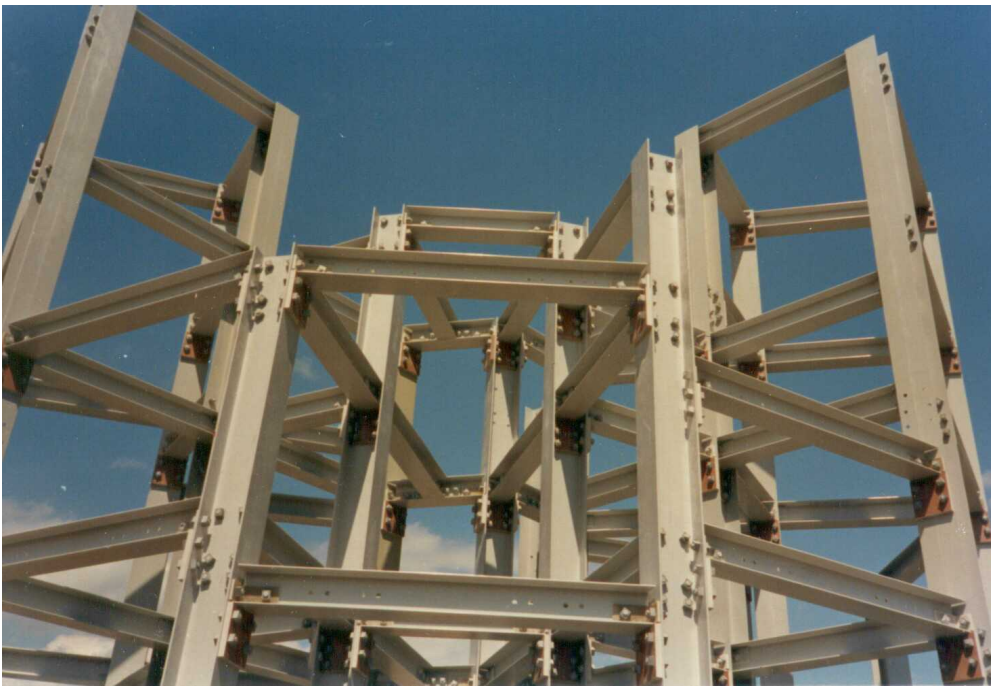

Nuclear test tower constructed using PuTex Standard Structural Profiles

“The first PulTex Design Manual was published in 1973. The New and Improved PulTex Pultrusion Design Manual of Standard and Custom Fiber Reinforced Polymer Structural Profiles, 2004 Edition, Volume 5 – Revision 15 is a tool for engineers to specify PulTex pultruded standard structural profiles. Creative Pultrusions, Inc. consistently improves its information to function as a solid reference for engineers.”

“No portion of this Design Manual may be reproduced in any form without the prior written consent of Creative Pultrusions, Inc.”

Volume 5 - Revision 15
Copyright© 2024 by
Creative Pultrusions, Inc.
All Rights Reserved Worldwide

Creative Pultrusions®, *Flowgrip®*, *PulTex®*, *Supergrate®*, *SUPERPILE®*, *Superplank®*, *SuperLoc®*, *SuperWale®*, *Superdeck®*, and *StormStrong®* are registered trademarks of Creative Pultrusions, Inc. *Superstud!™*, *Superstud!™/Nuts!*, *SUPURTUF™*, *Tuf-dek™*, *SuperCap™* and *SuperRod™* are trademarks of Creative Pultrusions, Inc.

**The New and Improved PulTex Pultrusion Design Manual
of Standard and Custom Fiber Reinforced Polymer Structural Profiles,
including Imperial Measurements
Table of Contents**

Volume 5 - Revision 15

Page Numbers

Chapter 1 Introduction To Pultrusion

PulTex	1 – 2
PulTex Pultrusion Process	2 – 3
Process Advantages	3
Raw Materials Used in the Pultrusion Process	3 – 4
PulTex Resin Systems	4 – 5

Chapter 2 Value Engineering

Design Benefits	1 – 2
Applications	2 – 3
Cost Analysis for Standard and Custom Profiles	3 – 4
Raw Material Advantages	4
Fabrication Advantages	4
Shipping Advantages	4

Chapter 3 Physical And Mechanical Properties

Introduction to Design with Pultruded Composites	1
Fiber Properties	1
Resin Properties	2
Fillers	2
Imperial Material Properties Sheets	
Material Properties of PulTex Fiber Reinforced Polymer Structural Profiles	3 – 4
Material Properties of PulTex Fiber Reinforced Polymer Flat Sheets	5 – 6
Material Properties of PulTex Fiber Reinforced Polymer Rods and Bars	7
Material Properties of Superstud™/Nuts! Square Nuts and Isoplast* Flanged Hex Nuts Fiber Reinforced Polymer Fastener Systems	8
Material Properties of PulTex SuperStructural Profiles – Wide Flange and I-Sections	9 – 10
Material Properties of PulTex SuperStructural Profiles – Angles	11 – 12
Procedures for Obtaining Properties	13 – 14
Safety Factors	15
Elements of Sections	
Imperial Elements of Section	16 – 22

*Trademark of The Dow Chemical Company

**The New and Improved PulTex Pultrusion Design Manual
of Standard and Custom Fiber Reinforced Polymer Structural Profiles,
including Imperial Measurements
Table of Contents**

Volume 5 - Revision 15

Page Numbers

Chapter 4 Load Tables For Flexural Members And Connections

Beam Deflections.....	1
Allowable Stresses.....	1
Lateral – Torsional Buckling.....	2 – 4
Stress Calculations for Channels.....	5 – 9
Local and Global Buckling of FRP Channels.....	10
Beam Deflection Formula.....	11 – 13
Examples of Beam Selection of PulTex Profiles used as Flexural Members.....	14 – 17
Channel Selection Example.....	17 – 18
Nomenclature.....	19 – 20
Introduction to PulTex SuperStructural Profiles.....	21
Comparison of Standard Structural Profiles and PulTex SuperStructural Profiles.....	21 – 23
Span/Deflection Ratio Conversion Tables.....	24 – 25
Allowable Uniform Load Tables.....	26 – 95
Connections	
Clip Connection Load Tables with PulTex SuperStructural Profiles.....	96 – 98
Bolt Hole Bearing Capacity.....	99 – 100
Design Example Using the Clip Connection Charts.....	101
Moment of Capacity of PulTex SuperStructural Angles.....	102 – 103
Designing a Connection with a Coped Flange.....	104
End Notes.....	105

Chapter 5 Load Tables For Compression Members

Load Tables For Compression Members.....	1
Introduction.....	2
PulTex Column Test Program.....	3 – 8
Nomenclature.....	9
Tables for Allowable Compressive Stresses and Loads.....	10
Imperial Tables for Allowable Compressive Stresses and Loads.....	11 – 48
Biography.....	49 – 50

Chapter 6 Environmental Considerations

Temperature.....	1
Weathering.....	1
UV Stabilizers.....	1
Resistance to Chemicals and Reagents.....	2
Chemical Compatibility Guide.....	3 – 10

**The New and Improved PulTex Pultrusion Design Manual
of Standard and Custom Fiber Reinforced Polymer Structural Profiles,
including Imperial Measurements
Table of Contents**

Volume 5 - Revision 15

Page Numbers

Chapter 7 Custom Profile Design

Wall-Section Thickness	1
Radius Design	1 – 2
Shrinkage	2
Surface Appearance and Performance	2 – 3
Parting Lines	3
Localized Stiffening	3
Undercuts	3
Dimensional Tolerances	3
Designer Checklist	4 – 5
Notes	6

Chapter 8 Quality Assurance And Standard Tolerances

Quality Assurance System	1
Standard Tolerances	1 – 8
Standard Dimensional Tolerances for Pultruded Shapes Fabrication (CPQ212.0915)	9

Chapter 9 Fabrication Techniques

Fabrication Techniques	1 – 2
Fabrication of PulTex Structural Profiles	2 – 3
Adhesives/Bonding	3
Advantage of Adhesives	3 – 4
Bonded Shear Joint Concepts	4 – 5
Surface Preparations	5
Adhesives Comparison Guide used with PulTex Profiles	6
Comparison of Joining Techniques	6
Machining Operations	7
Cutting Procedures	7
Operating Tips	7 – 8
Drilling	8
Grinding	9
Turning	9 – 10
Routing	10 – 11
Punching	11 – 12
Press Tonnage Requirements	12 – 14
Shear Angle in Punching	14
Other Useful Guidelines for Punching	15
Shearing	16

**The *New and Improved* PulTex Pultrusion Design Manual
of Standard and Custom Fiber Reinforced Polymer Structural Profiles,
including Imperial Measurements
Table of Contents**

Volume 5 - Revision 15

Page Numbers

Chapter 9 Fabrication Techniques (cont'd)

Painting	16
Surface Preparation	16
Joining PulTex Structural Profiles	17 – 19
Mechanical Fastenings	20 – 23
Notes	24

Chapter 10 Writing Specifications For PulTex Structural Profiles

Writing Specifications	1 – 6
------------------------------	-------

Appendices

Appendix A	1 – 2
Appendix B	3 – 4

Works Cited	1
--------------------------	---

PulTex Product Availability List

Imperial PulTex Product Availability List	1 – 2
---	-------

“Creative Pultrusions, Inc. believes the information put forth in this Design Manual to be as accurate and reliable as we can ascertain as of the date of publication. However, Creative Pultrusions, Inc. does not warrant that the information hereunder will not infringe the claims of any United States or other patents covering products or processes, or the use thereof in combination with other products or in the operation of any process.

User also agrees to indemnify and hold Creative Pultrusions, Inc. harmless from and against any and all losses, damages, and expenses (including attorney fees and other costs of defending any action) that Creative Pultrusions, Inc. may sustain or incur as a result of any claim, in connection with the use of the information in this manual.”

Chapter 1 Introduction to Pultrusion

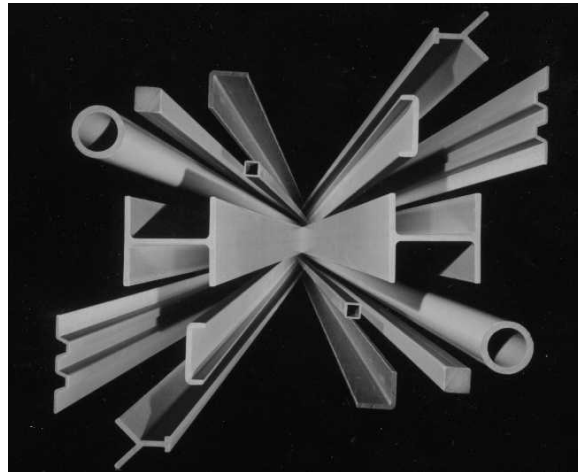

PulTex standard structural profiles are used in many highly corrosive applications.

Established in 1973, Creative Pultrusions is located in Alum Bank, Pennsylvania, and is a subsidiary of Hill & Smith PLC, an international group with leading positions in the design, manufacture and supply of infrastructure products and galvanizing services to global markets. It serves its customers from facilities principally in the UK, USA, Sweden, India and Australia. Headquartered in the UK and quoted on the London Stock Exchange (LON: HILS), Hill & Smith PLC employs some 4,500 staff, principally in 5 countries. PulTex is the registered trademark of Creative Pultrusions, Inc. (CP) for products made by the pultrusion process. PulTex profiles are Pultruded Fiber Reinforced Polymer (FRP) components, manufactured from a wide variety of high-performance thermosetting resins and reinforcements, classifying pultrusion as a structural engineering material. As a result, PulTex profiles have been used extensively in many industries for construction, corrosion-resistant, electrical/electronic, transportation, consumer and water/wastewater applications.

Within the last two decades, the pultrusion process has been used by the design engineer as having the capability of manufacturing products that solve many modern problems. As a result, high-strength, light-weight and maintenance-free products and structures have been designed and built.

The *New and Improved PulTex Pultrusion Design Manual* is developed to aid the design engineer in understanding the pultrusion process and how various elements of the process and design affect the performance and cost of the final product.

The information provided is the result of many years of participation with industries worldwide. Applications vary from the development of new high-performance springs and bumpers for the automotive industry to corrosion-resistant structural I-beams, channels and angles for the chemical processing industry.

With The *New and Improved PulTex Pultrusion Design Manual*, you, the design engineer, will share in the knowledge and experience to assist in the design of your future pultrusion requirements.



Fiberglass platform systems are ideal in highly corrosive areas.



Bridges are easily installed in hard-to-access areas.



An integrated building system is lightweight, easy to erect and maintenance-free.

PulTex Pultrusion Process

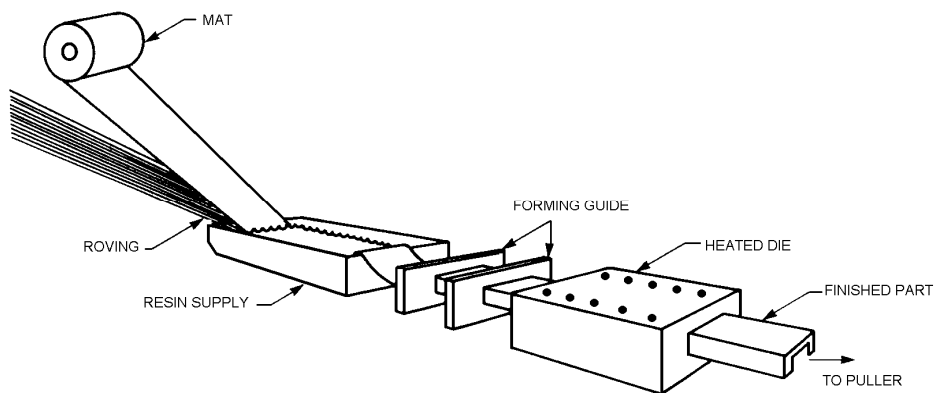

PulTex Pultrusion Process (cont'd)

Pultrusion is a continuous molding process using fiber reinforcement in polyester or other thermosetting resin matrices.

Pre-selected reinforcement materials, such as fiberglass roving, mat or cloth, are drawn through a resin bath in which all material is thoroughly impregnated with a liquid thermosetting resin.

The wet-out fiber is formed to the desired geometric shape and pulled into a heated steel die. Once inside the die, the resin cure is initiated by controlling precise elevated temperatures. The laminate solidifies in the exact cavity shape of the die, as it is continuously pulled by the pultrusion machine.

Process Advantages

The process provides maximum flexibility in the design of pultruded FRP profiles. Currently, profiles up to 72 inches wide and 21 inches high are possible. Since the process is continuous, length variations are limited to shipping capabilities.

Specific strength characteristics can be designed into the composite, optimizing laminate performance for a particular application by strategic placement of high performance reinforcements. Color is uniform throughout the cross section of the profile, eliminating the need for many painting requirements.

Processing capabilities include the production of both simple and complex profiles, eliminating the need for much post-production assembly of components. PulTex profiles can result in more satisfactory performance of your finished products and structures.

Raw Materials Used in the Pultrusion Process



Each resin mix is formulated carefully to suit application requirements.



Roving and mat are of major importance in determining physical properties.

Resin

Selected high performance polyester resins are combined with suitable fillers, catalysts, UV inhibitors and pigments to formulate the resinous matrix, binding the fibers together and providing the structural corrosion resistance and other properties required. Although the vast majority of applications can be serviced by the variety of polyester resins available, certain application requirements of higher strength or corrosion resistance can be satisfied with the selection of vinyl ester.

Roving

Fiberglass roving provides the high longitudinal strength of pultruded products. The amount and location of these reinforcements can be determined in the design stage and can alter the subsequent physical properties of the finished product. Roving also provides the tensile strength needed to pull the other reinforcements through the die; therefore, it is a necessary ingredient in the profile design.

Mat

Continuous strand mat provides the most economical method of obtaining a high degree of transverse physical properties. The mats are layered with roving; this process forms the basic composition found in most pultruded products. The ratio of mat to roving determines the relationship of transverse to longitudinal physical properties.

Veil

Since pultrusion is a low-pressure process, fiberglass reinforcements normally appear close to the surface of the product. These can affect the appearance, corrosion resistance or handling of the products. Surface veils can be added to the laminate construction to displace the reinforcement from the surface adding a resin-rich finish to the profile. The two most commonly used veils are A-glass and polyester.

PulTex Resin Systems

Resin mixtures, glass content and their combination can be altered to achieve special properties in a profile due to the versatility of the pultrusion process. The specific resin formula may be adjusted for each profile due to processing requirements.

Table 1-1 Available Resin Systems

PulTex Resin Series	Characteristics	Typical Applications
1500 Polyesters	Good chemical resistance combined with high mechanical and electrical properties.	Standard Structural used in moderately corrosive environments Crossing gate arms Dunnage bars Ladders
1525 Fire Retardant Polyesters	A flame spread rating of 25 or less when tested per ASTM E-84 plus the attributes of 1500 Series profiles. UL 94 VO rating also available on request.	Fire retardant standard structurals
1600 Vinyl esters	Excellent corrosion resistance, as well as, improved physical properties and elevated service temperature capabilities.	High performance standard structurals
1625 Fire Retardant Vinyl esters	Same as Series 1600 plus the added bonus of a 25 or less rating per ASTM E84 and low smoke generation.	High performance standard structurals for severely corrosive environments
2020 Low Profile Modified Polyester Resin System	Profiles requiring optimum surface finish	Transportation

Table 1-1 Available Resin Systems (cont'd)

PulTex Resin Series	Characteristics	Typical Applications
3535 Modified Polyester	Halogen free, low flame and smoke.	Mass Transit Electrical

Reference The PulTex Product Availability List for stocked items.

Other special resin systems are available; please contact the Engineering Department of Creative Pultrusions, Inc.

Woven and Stitched Fabric

When the mix of required physical properties is not satisfied by conventional mat roving construction, selected fabrics can be used to meet the end use requirements. Varieties of these products can be used by themselves or in conjunction with the standard mat roving construction to obtain the necessary results. The fiberglass fabrics are available in balanced, high longitudinal, high transverse or $\pm 45^\circ$ multi-ply construction. Since these materials are more costly, the composites using these reinforcements are more expensive than standard construction pultrusion.

Other Reinforcing Material

Carbon and aramid fibers are also used in the pultrusion process in roving, woven fabric forms, or in combination with fiberglass. These high modulus fibers add considerable stiffness to the composite. Care must be taken when designing profiles with carbon and aramid fiber materials since they are more costly. The composite should be designed for optimum performance.



Surfacing veils enhance the finished profile and increase corrosion resistance.



Woven/stitched goods increase transverse properties of pultruded profiles.

Chapter 2 Value Engineering

Design Benefits

Many advantages exist in using PulTex Profiles, compared to conventional materials, such as steel, aluminum, wood or other plastics. Analyzing the benefits of PulTex can mean a cost savings to you.

The first step is to compile the total cost of the application, which includes: tooling, raw materials and any required fabrication. Costs are easily obtained from the Sales and Estimating Department of Creative Pultrusions.

The second step is to add the cost savings that would be realized by you and the end user, in comparison to using conventional construction materials. These savings are realized in reduced maintenance cost, lower installation cost and reduced freight, due to lighter weight properties. Savings in the life cycle of the product should be considered with the product's original cost when making cost comparisons.



Light weight, high strength and electrical insulating properties make FRP profiles ideal for third-rail coverboard on electrical mass transit systems around the world.

Table 2-1 Features & Benefits of PulTex Profiles

Features	Description	Benefits
Strength	Unit strength in tension, flexure, and compression is approximately 20 times that of steel when properties are combined on the basis of unit density	<ul style="list-style-type: none"> • Structural design capabilities • Optional strength in desired directions • Exceptionally high impact strengths
Lightweight	Density of PulTex is 20% of steel and 60% of aluminum	<ul style="list-style-type: none"> • Higher performance at less weight • Reduced shipping costs • Reduced operational energy demands • Reduced labor expense for installations • Easily handled • Assembled and installed with ease
Corrosion Resistance	Unaffected by a wide range of corrosive chemicals and environments	<ul style="list-style-type: none"> • Minimal maintenance costs • Long-term safety • Installation longevity and increased service life • Outdoor storage capabilities • Lower cost performance ratio • Less need for replacements
Electrical Insulation	Structural strength and rigidity are provided with dielectric material.	<ul style="list-style-type: none"> • Less components for assemblies • Non-magnetic • Additional safety factors • Predictable insulation values
Part Consolidation	Many individual components can be combined into one large profile.	<ul style="list-style-type: none"> • Reduced assembly costs • Reduced inventory requirements • Smooth aerodynamic surfaces • Improved reliability
Dimensional Stability	Stretch-, warp-, and swell-resistant over a wide range of temperatures and physical stresses.	<ul style="list-style-type: none"> • No permanent set under high stress • Reduced damage to structure assemblies • Easy to repair misused parts • Close tolerances
Thermal Insulation	Low thermal conductivity rating of 1/250 of aluminum; 1/60 of steel	<ul style="list-style-type: none"> • Reduced insulation thickness requirements • Reduced energy operation requirements • No condensation problems

Applications

Construction/Industrial

- Bridges
- Bulk head frames
- Cable trays
- Complete building systems
- Cooling tower components
- Flooring supports
- Grating and supports
- Pipe supports
- Prefabricated walkways, platforms and handrail systems
- Structural supports for process equipment
- Trusses and joists
- Wind blades
- Window frames

Applications (cont'd)

Automotive	Automobile springs Automotive leaf springs and bumpers Bus components Bus window latch supports Dunnage bars Roll-up doors/ insulated roll-up door panels Spring bumpers Tank supports Truck/trailer wall posts
Consumer	Ladders Light poles Mop, broom and brush handles Pruning poles Rake handles Shovel handles
Wastewater	Cell partitions Scrubber components Traveling water screens Water/waste water treatment sludge flights
Electrical	Composite utility poles Crossarms Crossing gate arms Electrical enclosures Mist eliminators Mounting braces & backboards Switch gear components Third rail coverboards Walk-in refrigeration door jambs
Marine	Boat dock power posts Fender pilings Sheetpiles

Cost Analysis for Standard and Custom Profiles

Careful study of end-use requirements for an application will establish the potential for use of PulTex. If possible, designs should be drawn and the commercial feasibility determined.

The applied cost of the end uses of a pultruded profile is the sum of the tooling, raw material and fabrication, plus the additional consideration of transportation, assembly and/or erection/installation cost.

In many cases of mechanical design or prototyping, standard PulTex Profiles can be used. The most economical alternative for the designer is to evaluate the material, as it may eliminate elements of cost, such as development time, tooling, and manufacturing for limited quantity runs. Even custom profiles can be effectively fabricated and/or assembled from available standard profiles, aiding the designer in determining the feasibility of an idea with minimal cost.

Tooling Costs

When the feasibility is determined and a custom profile is required, the following factors must be considered:

1. Products selected from the list of available PulTex standard structural profiles involve no additional tooling cost and are normally available in any quantity through the distribution network.
2. Tooling costs for custom pultruded profiles are dependent on the complexity of the profile and the volume requirements, and are often less than those for traditional materials.

Raw Material Advantages

PulTex 1500 and 1525 Series are produced with high performance grades of polyester resin, continuous strand mat and roving. The combination provides a quality product that is economically priced.

When the application requires higher performance ratings for standard or custom profiles, it can be engineered with specialized reinforcements and resins.

Although premium raw materials also affect the cost of a product by adding complexity and possibly lowering production rates, the benefits realized can usually justify the additional costs. High-performance resins or specialized reinforcements can improve usable life or ultimate strength of a profile.

Fabrication Advantages

Creative Pultrusions provides a full-service Fabrication Network that offers painting, punching, multi-head drilling and assembly. If you choose to do your own fabrication, Creative Pultrusions can provide recommendations on methods and equipment to be used based on extensive experience. Chapter 9 provides many helpful hints in determining the optimum fabrication techniques.

Shipping Advantages

Shipping of components or sections is one segment of costs sometimes neglected in early design stages. It particularly applies to glass-reinforced products, such as pultrusions, due to their lower density. In most shipments, the volume of a shipping container is completely filled before the maximum shipping weight is reached; therefore, it is important for the designer to consider this fact when designing the profile. The ability to stack or crate the profile will affect the end-product costs.

Another consideration is length. Since pultrusion is a continuous process, it allows the designer to use any length product possible. The only limitation is that profiles must be practical shipping lengths. Standard shipping lengths are usually 45 feet or less to fit the length of most common carriers. Rods or smaller profiles, which can be coiled, have a theoretically unlimited length, although there are some process limitations.

Chapter 3 Physical and Mechanical Properties

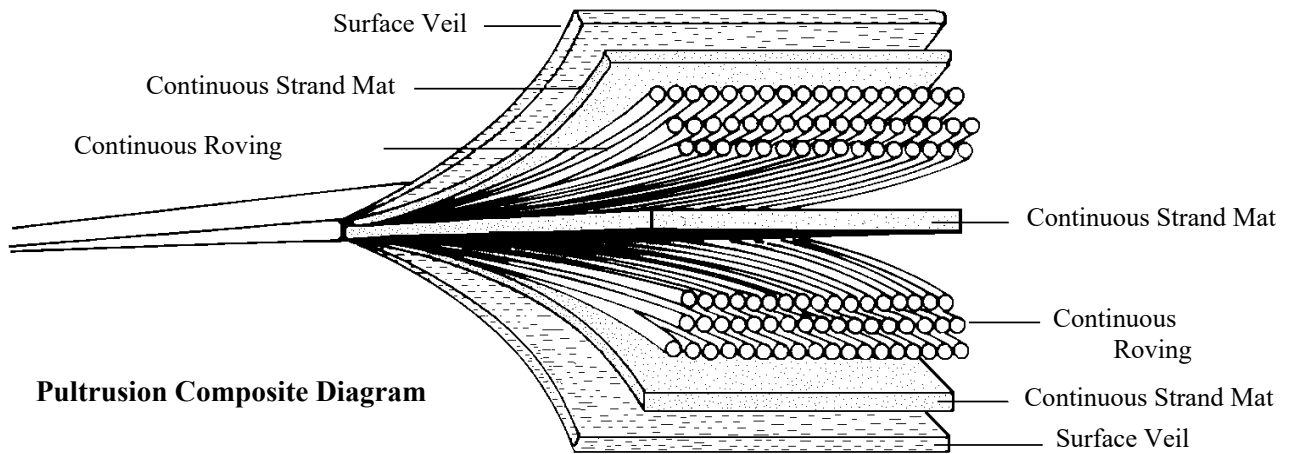

Introduction To Design With Pultruded Composites

A pultrusion is a composite of several materials and reinforcements. It presents the opportunity to design product components with properties to meet specific needs. Fiber reinforcements and loadings can be varied to produce a wide range of structural properties in the end product.

Typical structural items contain 45% to 75% glass by weight. This composite type is widely used in the pultrusion industry for determining the standard mechanical properties of pultrusion, and can be modified, if necessary, for special applications. Tensile strengths, for example, can vary from 40 MPa to 1000 MPa, depending on the glass loading, fiber orientation and resin selection.

Fiber Properties

A variety of continuous and woven reinforcement types is also available to the designer. The four major types are E-GLASS, S-GLASS, ARAMID and CARBON. The primary type used is E-glass. Other reinforcements are more costly; and, therefore, used more sparingly in construction.

Table 3-1 Typical Properties of Fibers Used in Pultruded Structural Profiles

Properties are displayed below for virgin fibers, as manufactured.

Property	E-Glass	S-Glass	Aramid	Carbon
Density lbs/in ³	.094	.090	.053	.064
Tensile Strength (psi)	500,000	665,000	400,000	275,000-450,000
Tensile Modulus (10 ⁶ psi)	10.5	12.6	9.0	33-55
Elongation to break (%)	4.8	5.4	2.3	0.6-1.2

Fiber reinforcements are available in a variety of single-strand woven, braided, stitched, and knitted goods, thus adding to the range of properties of the end composite.

Resin Properties

Determination of resin is controlled by factors such as corrosive environments, temperature exposure, and flame retardancy.

Polyesters are the primary resins used in pultrusion. A wide range of polyesters is available with distinct characteristics. The capabilities and needs for these various resins can only be determined by end-use applications. For the selection of a particular polyester, the designer should consult Creative Pultrusions.

Fire-retardant polyesters are also available. Fire retardancy can be altered with the proper blending of different resins. Some of the obtainable results on flammability specifications and tests are presented further in the Material Properties. For superior fire retardancy, phenolic or other specialty resins may be used.

Vinyl ester resins are also commonly used in the pultrusion process. They are used to improve the chemical resistance of the laminate. Because of their chemistry with glass reinforcements, physical properties of the laminate can be expected to increase up to 15%.

Epoxy resins are typically used with carbon fiber reinforcements in applications in which high stiffness and strength requirements are critical. They can also be used with E-glass to improve the physical properties.

Table 3-2 Typical Properties of Resins Used in Pultruded Structural Profiles

Property	Polyester	Vinyl ester	Epoxy	Test Method
Tensile Strength (psi)	11,200	11,800	11,000	ASTM D638
% Elongation	4.5	5	6.3	ASTM D638
Flexural Strength (psi)	17,800	20,000	16,700	ASTM D790
Flexural Modulus (10 ⁶ psi)	0.43	0.54	0.47	ASTM D790
Heat Distortion Temperature (°F)	160	220	330	ASTM D648
Short Beam Shear (psi)	4,500	5,500	8,000	ASTM D2344

Fillers

Various fillers are also used in the pultrusion process. Aluminum silicate (kaolin clay) is used for improved chemical resistance, opacity, good surface finish and improved insulation properties. Calcium carbonate offers improved surfaces, whiteness, opacity and general lowering of costs. Alumina trihydrate and antimony trioxide are used for fire retardancy. Alumina trihydrate can also be used in conjunction with clays for improved insulation properties.

MATERIAL PROPERTIES

PulTex Fiber Reinforced Polymer Structural Profiles Rectangular Tubes, Channels, Angles, Square Tubes, Round Tubes

*Includes all angles except 4" x 1/4", 4" x 3/8", 6" x 3/8" and 6" x 1/2", which are **SuperStructurals**.
Please consult the PulTex Fiber Reinforced Polymer **SuperStructural** Profiles Angles Material Properties*

1500 Series - Thermoset Polyester – Olive Green

1525 Series - Thermoset Polyester Class 1 FR – Slate Gray (Dark Gray)

1625 Series - Thermoset Vinyl Ester Class 1 FR – Beige

The following data was derived from ASTM coupon and full section testing. The results are average values based on random sampling and testing of production lots. Composite materials are not homogeneous; and therefore, the location of the coupon extraction can cause variances in the coupon test results. Creative Pultrusions publishes an average value of random samples from production lots.

<u>Property</u> (coupon values)	ASTM Test	Units	1500/1525 Series	1625 Series
Mechanical				
Tensile Strength (LW)	D638	psi	33,000	37,500
Tensile Strength (CW)	D638	psi	7,500	8,000
Tensile Modulus (LW)	D638	10 ⁶ psi	2.5	3.0
Tensile Modulus (CW)	D638	10 ⁶ psi	0.8	1.0
Compressive Strength (LW)	D695	psi	33,000	37,500
Compressive Strength (CW)	D695	psi	16,500	20,000
Compressive Modulus (LW)	D695	10 ⁶ psi	3.0	3.0
Compressive Modulus (CW)	D695	10 ⁶ psi	1.0	1.2
Flexural Strength (LW)	D790	psi	33,000	37,500
Flexural Strength (CW)	D790	psi	11,000	12,500
Flexural Modulus (LW)	D790	10 ⁶ psi	1.6	2.0
Flexural Modulus (CW)	D790	10 ⁶ psi	0.8	1.0
Modulus of Elasticity	Full Section ²	10 ⁶ psi	2.8-3.2	2.8-3.2
(Channels)	Full Section ²	10 ⁶ psi	2.8	2.8
(Square and Rectangular Tubes)	Full Section ²	10 ⁶ psi	3.2	3.2
Shear Modulus	Full Section ²	10 ⁶ psi	0.42	0.42
Interlaminar Shear (LW) ³	D2344	psi	4,500	4,500
Shear Strength By Punch (PF)	D732	psi	5,500	6,000
Notched Izod Impact (LW)	D256	ft-lbs/in	28	30
Notched Izod Impact (CW)	D256	ft-lbs/in	4	5
Maximum Bearing Strength (LW)	D953	psi	30,000	30,000
Maximum Bearing Strength (CW)	D953	psi	18,000	18,000
Poisson's Ratio (LW)	D3039	in/in	0.35	0.35
Poisson's Ratio (CW)	D3039	in/in	0.15	0.15
In-plane Shear (LW)	Modified D2344 ⁴	psi	7,000	7,000

LW = lengthwise

CW = crosswise

PF = perpendicular to laminate face

Additional properties located on page 4

MATERIAL PROPERTIES

PulTex Fiber Reinforced Polymer Structural Profiles Rectangular Tubes, Channels, Angles, Square Tubes, Round Tubes

*Includes all angles except 4" x 1/4", 4" x 3/8", 6" x 3/8" and 6" x 1/2", which are **SuperStructurals**.
Please consult the PulTex Fiber Reinforced Polymer **SuperStructural** Profiles Angles Material Properties*

Property (coupon values)	ASTM Test	Units	1500/1525 Series	1625 Series
Physical				
Barcol Hardness ¹	D2583		45	45
Water Absorption	D570	% Max	0.6	0.6
Density	D792	lbs/in ³	0.060-0.070	0.060-0.070
Specific Gravity	D792		1.66-1.93	1.66-1.93
Coefficient of Thermal Expansion (LW)	D696	10 ⁻⁶ in/in/°F	4.4	4.4
Thermal Conductivity (PF)	C177	BTU-in/ft ² /hr/°F	4	4
Electrical				
Arc Resistance (LW)	D495	seconds	120	120
Dielectric Strength (LW)	D149	KV/in	40	40
Dielectric Strength (PF)	D149	volts/mil	200	200
Dielectric Constant (PF)	D150	@60Hz	5.2	5.2

¹ PulTex uses a synthetic surface veil that reduces the Barcol Hardness, but does not reflect lack of cure.

² Full section testing based on a 3-point bend with simply supported end conditions (Reference [The New and Improved PulTex Pultrusion Global Design Manual](#), Appendix B, for details).

³ Tested on a 3:1, span to depth ratio.

⁴ Follow ASTM D2344, but rotate coupon 90° (cut section of coupon length faces up).

⁵ In-plane Shear (CW) values for square tubes and rectangular tubes = 2,500 psi; angles = 3,800 psi

Property	ASTM Test	Value	
		1525	1625
Flammability Classification	UL94	(VO)	(VO)
Tunnel Test	ASTM E-84	25 Max	25 Max
Flammability Extinguishing	ASTM D635	Self extinguishing	Self extinguishing
NBS Smoke Chamber	ASTM E662	650	650

Creative Pultrusions, Inc. believes the information put forth in this property sheet to be as accurate and reliable as of the date of publication. However, we assume no obligation or liability, which may arise as a result of its use. While Creative Pultrusions, Inc. has no knowledge that the information put forth infringes any valid patent, it assumes no responsibility with respect thereto and each user must satisfy oneself that one's intended application process or product infringes no patent.

MATERIAL PROPERTIES

PulTex Fiber Reinforced Polymer Flat Sheets

1500 Series - Thermoset Polyester – Olive Green

1525 Series - Thermoset Polyester Class 1 FR – Slate Gray (Dark Gray)

1625 Series - Thermoset Vinyl Ester Class 1 FR – Beige

The following data was derived from ASTM coupon and full section testing. The results are average values based on random sampling and testing of production lots. Composite materials are not homogeneous; and therefore, the location of the coupon extraction can cause variances in the coupon test results. Creative Pultrusions publishes an average value of random samples from production lots.

Property (coupon values)	ASTM Test	Units	1500/1525 Series	1625 Series
Mechanical				
Flexural Strength, Flatwise (LW)	D790	psi	35,000	35,000
Flexural Strength, Flatwise (CW)	D790	psi	15,000	15,000
Flexural Modulus, Flatwise (LW)	D790	10 ⁶ psi	2.0	2.0
Flexural Modulus, Flatwise (CW)	D790	10 ⁶ psi	1.1	1.1
Tensile Strength (LW)	D638	psi	20,000	20,000
Tensile Strength (CW)	D638	psi	10,000	10,000
Tensile Modulus (LW)	D638	10 ⁶ psi	1.8	1.8
Tensile Modulus (CW)	D638	10 ⁶ psi	1.0	1.0
Compressive Strength, Edgewise (LW)	D695	psi	24,000	24,000
Compressive Strength, Edgewise (CW)	D695	psi	16,000	16,000
Compressive Modulus, Edgewise (LW)	D695	10 ⁶ psi	1.8	1.8
Compressive Modulus, Edgewise (CW)	D695	10 ⁶ psi	1.0	1.0
Notched Izod Impact (LW)	D256	ft-lbs/in	20	20
Notched Izod Impact (CW)	D256	ft-lbs/in	5	5
Bearing Strength (LW)	D953	psi	32,000	32,000
Bearing Strength (CW)	D953	psi	32,000	32,000
Poisson's Ratio (LW)	D3039	in/in	0.32	0.32
Poisson's Ratio (CW)	D3039	in/in	0.25	0.25
Physical				
Barcol Hardness ¹	D2583		40	40
Water Absorption	D570	% Max	0.6	0.6
Density	D792	lbs/in ³	0.060-0.070	0.060-0.070
Specific Gravity	D792		1.66-1.93	1.66-1.93
Coefficient of Thermal Expansion (LW)	D696	10 ⁻⁶ in/in/°F	8.0	8.0
Electrical				
Arc Resistance (LW)	D495	seconds	120	120
Dielectric Strength (LW)	D149	KV/in	40	40
Dielectric Strength (PF)	D149	volts/mil	200	200
Dielectric Constant (PF)	D150	@60Hz	5.2	5.2

¹ PulTex uses a synthetic surface veil that reduces the Barcol Hardness, but does not reflect lack of cure.

Additional Properties located on page 6

MATERIAL PROPERTIES

PulTex Fiber Reinforced Polymer Flat Sheets

(cont'd)

Property	ASTM Test	Value	Value
Flammability Classification	UL94	<u>1525</u> (VO)	<u>1625</u> (VO)
Tunnel Test	ASTM E-84	25 Max	25 Max
Flammability Extinguishing	ASTM D635	Self extinguishing	Self extinguishing
NBS Smoke Chamber	ASTM E662	650	650

Creative Pultrusions, Inc. believes the information put forth in this property sheet to be as accurate and reliable as of the date of publication. However, we assume no obligation or liability, which may arise as a result of its use. While Creative Pultrusions, Inc. has no knowledge that the information put forth infringes any valid patent, it assumes no responsibility with respect thereto and each user must satisfy oneself that one's intended application process or product infringes no patent.

MATERIAL PROPERTIES

PulTex Fiber Reinforced Polymer Rods And Bars

1500 Series - Thermoset Polyester – Olive Green

1525 Series - Thermoset Polyester Class 1 FR – Slate Gray (Dark Gray)

1625 Series - Thermoset Vinyl Ester Class 1 FR – Beige

The following data was derived from ASTM coupon and full section testing. The results are average values based on random sampling and testing of production lots. Composite materials are not homogeneous; and therefore, the location of the coupon extraction can cause variances in the coupon test results. Creative Pultrusions publishes an average value of random samples from production lots.

Rod and Bar stock contain longitudinal reinforcements only.

Property (coupon values)	ASTM Test	Units	Test Results
Mechanical			
Tensile Strength (LW)	D638	psi	100,000
Tensile Modulus (LW)	D638	10 ⁶ psi	6.0
Compressive Strength (LW)	D695	psi	60,000
Flexural Strength (LW)	D790	psi	100,000
Flexural Modulus (LW)	D790	10 ⁶ psi	6.0
Notched Izod Impact (LW)	D256	ft-lb/in	40
Physical			
Barcol Hardness Units	D2583	-	50
Water Absorption	D570	% Max	.25
Density	D792	lbs/in ³	0.073-0.076
Coefficient of Thermal Expansion (LW)	D696	10 ⁻⁶ in/in/°F	3.0

LW - lengthwise

Creative Pultrusions, Inc. believes the information put forth in this property sheet to be as accurate and reliable as of the date of publication. However, we assume no obligation or liability, which may arise as a result of its use. While Creative Pultrusions, Inc. has no knowledge that the information put forth infringes any valid patent, it assumes no responsibility with respect thereto and each user must satisfy oneself that one's intended application process or product infringes no patent.

MATERIAL PROPERTIES

Superstud!TM/Nuts! Square Nuts and Isoplast* Flanged Hex Nuts Fiber Reinforced Polymer Fastener System

Physical/Mechanical Properties	Type of Nut	ASTM Test	Units	Diameter /Threads per Inch					
				3/8" 16 UNC	1/2" 13 UNC	5/8" 11 UNC	3/4" 10 UNC	1" 8 UNC	
Ultimate Thread Shear Strength ^{1 2 3}	CP Square Nut		lbs.	811	1,880	2,198	2,692	6,616	
	CP Molded Hex Nut		lbs.	1,509	2,088	2,586	3,451	6,522	
Flexural Strength ^{2 3 5}		D790	psi	64,405	68,703	65,170	58,119	54,421	
Flexural Modulus ²		D790	10 ⁶ psi	2.4	2.8	2.7	2.8	2.6	
Ultimate Double Shear Strength ^{2 3 4}		B565	load lb.	4,142	7,071	7,186	11,446	22,987	
Dielectric Strength		D149	kV/in	35	35	35	35	35	
Water Absorption 24 hr Immersion		D570	%	1	1	1	1	1	
Coefficient of Thermal Expansion (LW)		D696	10 ⁻⁶ in/in/°F	5.0	5.0	5.0	5.0	5.0	
Maximum Recommended Torque Strength Using CP Square Nut Lubricated with SAE 10W30 Motor Oil ¹	CP Square Nut		ft-lbs	4	8	16	24	50	
	CP Molded Hex Nut		ft-lb	4	8	16	24	50	
Stud Weight			lb/ft	0.076	0.129	0.209	0.315	0.592	
			lb/ft	0.076	0.129	0.209	0.315	0.592	
Flammability	CP Square Nut	D635	Self-Extinguishing on All						
	CP Molded Hex Nut		-	-	-	-	-	-	
Thickness Nut	CP Square Nut		in	0.437	0.562	0.688	0.813	1.062	
	CP Molded Hex Nut		in	0.750	0.855	1.220	1.590	1.750	
Width Nut	CP Square Nut		in	0.688	0.875	1.062	1.250	1.625	
	CP Molded Hex Nut		in	0.745	1.000	1.250	1.950	2.000	

1 Applies to single nut only.

2 Values statistically derived per ASTM D7290 on the actual studs.

3 Appropriate safety factors shall be applied.

4 Single Shear can be estimated by dividing the double shear value in half.

5 Flexural strength governed by compression failure. Therefore, flexural and compression strength are the same in bending.

***Trademark of The Dow Chemical Company**

Note: Superstud!TM is intended to be used only with the CP molded and square nuts. Steel nuts are excluded.

Creative Pultrusions, Inc. believes the information put forth in this property sheet to be as accurate and reliable as of the date of publication. However, we assume no obligation or liability which may arise as a result of its use. While Creative Pultrusions, Inc. has no knowledge that the information put forth infringes any valid patent, it assumes no responsibility with respect thereto and each user must satisfy oneself that one's intended application process or product infringes no patent.

MATERIAL PROPERTIES

PulTex Fiber Reinforced Polymer **SuperStructural** Profiles *Wide Flange Sections and I-Sections*

1500 Series - Thermoset Polyester – Olive Green

1525 Series - Thermoset Polyester Class 1 FR – Slate Gray (Dark Gray)

1625 Series - Thermoset Vinyl Ester Class 1 FR – Beige

PulTex **SuperStructural** Profiles are identified with imprinted veil.

The following data was derived from ASTM coupon and full section testing. The results are average values based on random sampling and testing of production lots. Composite materials are not homogeneous; and therefore, the location of the coupon extraction can cause variances in the coupon test results. Creative Pultrusions publishes an average value of random samples from production lots.

Property (coupon values)	ASTM Test	Units	1500/1525 Series	1625 Series
Full Section				
Modulus of Elasticity (1/2" thick profiles)	Full Section ²	10 ⁶ psi	3.9-4.0	3.9-4.0
(1/4" & 3/8" thick profiles)	Full Section ²	10 ⁶ psi	3.9	3.9
Shear Modulus (Modulus of Rigidity)	Full Section ²	10 ⁶ psi	4.0	4.0
Flexural Strength	Full Section ²	psi	0.50	0.50
			33,000	33,000
Flange Section - Mechanical				
Tensile Strength (LW)	D638	psi	40,000	46,000
Tensile Modulus (LW)	D638	10 ⁶ psi	4.16	4.16
Compressive Strength (LW)	D695	psi	45,770	52,500
Compressive Strength (CW)	D695	psi	17,800	20,400
Compressive Modulus (LW)	D695	10 ⁶ psi	3.85	3.85
Compressive Modulus (CW)	D695	10 ⁶ psi	1.9	1.9
Flexural Strength (LW)	D790	psi	42,800	49,200
Flexural Modulus (LW)	D790	10 ⁶ psi	2.0	2.0
Interlaminar Shear (LW) ⁵	D2344	psi	4,000	4,500
Shear Strength By Punch (PF)	D732	psi	5,500	6,000
Notched Izod Impact (LW)	D256	ft-lbs/in	28	32
Notched Izod Impact (CW)	D256	ft-lbs/in	21	24
Maximum Bearing Strength (LW)	D953	psi	33,000	38,000
Maximum Bearing Strength (CW) ³	D953	psi	23,000	26,500
Poisson's Ratio (LW)	D3039	in/in	0.35	0.35
Poisson's Ratio (CW)	D3039	in/in	0.12	0.12
Web Section - Mechanical				
Tensile Strength (LW)	D638	psi	30,300	35,000
Tensile Strength (CW)	D638	psi	10,500	12,000
Tensile Modulus (LW)	D638	10 ⁶ psi	3.1	3.1
Tensile Modulus (CW)	D638	10 ⁶ psi	1.4	1.4
Compressive Strength (LW)	D695	psi	37,500	43,125
Compressive Strength (CW)	D695	psi	14,200	16,330

MATERIAL PROPERTIES

PulTex Fiber Reinforced Polymer **SuperStructural** Profiles Wide Flange Sections and I-Sections (cont'd)

Property (coupon values)	ASTM Test	Units	1500/1525 Series	1625 Series
Web Section - Mechanical				
Compressive Modulus (LW)	D695	10 ⁶ psi	2.8	2.8
Compressive Modulus (CW)	D695	10 ⁶ psi	1.9	1.9
Flexural Strength (LW)	D790	psi	43,320	49,800
Flexural Strength (CW)	D790	psi	17,360	19,900
Flexural Modulus (LW)	D790	10 ⁶ psi	1.9	1.9
Flexural Modulus (CW)	D790	10 ⁶ psi	1.75	1.75
Interlaminar Shear (LW) ⁵	D2344	psi	3,400	3,900
Shear Strength By Punch (PF)	D732	psi	5,500	6,000
Notched Izod Impact (LW)	D256	ft-lbs/in	38	43
Notched Izod Impact (CW)	D256	ft-lbs/in	19	22
Maximum Bearing Strength (LW)	D953	psi	33,980	39,000
Maximum Bearing Strength (CW) ³	D953	psi	30,000	34,500
Poisson's Ratio (LW)	D3039	in/in	0.35	0.35
Poisson's Ratio (CW)	D3039	in/in	0.12	0.12
In-plane Shear (LW)	Modified D2344 ⁴	psi	7,000	7,000
Physical				
Barcol Hardness ¹	D2583		33	39
Water Absorption	D570	% Max	0.6	0.6
Density	D792	lbs/in ³	0.060-0.070	0.060-0.070
Specific Gravity	D792		1.66-1.93	1.66-1.93
Coefficient of Thermal Expansion (LW)	D696	10 ⁻⁶ in/in/°F	4.4	4.4
Thermal Conductivity (PF)	C177	BTU-in/ft ² /hr/°F	4	4
Electrical				
Arc Resistance (LW)	D495	seconds	120	120
Dielectric Strength (LW)	D149	KV/in	40	40
Dielectric Strength (PF)	D149	volts/mil	200	200
Dielectric Constant (PF)	D150	@60Hz	5.2	5.2

LW = lengthwise

CW = crosswise

PF = perpendicular to laminate face

¹PulTex uses a synthetic veil that reduces the Barcol Hardness, but does not reflect lack of cure.

²Full section testing is based on a 3-point bend with simply supported end conditions (Reference *The New and Improved PulTex Pultrusion Global Design Manual* Appendix for details).

³Crosswise bearing strength of the Web sections of 1/4" profiles = 20,500 psi.

⁴Follow ASTM D2344, but rotate coupon 90° (cut section of coupon length faces up).

⁵Tested on a 3:1, span to depth ratio.

Property	ASTM Test	Value	
		1525	1625
Flammability Classification	UL94	(VO)	(VO)
Tunnel Test	ASTM E-84	25 Max	25 Max
Flammability Extinguishing	ASTM D635	Self extinguishing	Self extinguishing
NBS Smoke Chamber	ASTM E662	650	650

Creative Pultrusions, Inc. believes the information put forth in this property sheet to be as accurate and reliable as of the date of publication.

However, we assume no obligation or liability, which may arise as a result of its use. While Creative Pultrusions, Inc. has no knowledge that the information put forth infringes any valid patent, it assumes no responsibility with respect thereto and each user must satisfy oneself that one's intended application process or product infringes no patent.

MATERIAL PROPERTIES

PulTex Fiber Reinforced Polymer **SuperStructural** Profiles *Angles*

SuperStructural Angle sizes are: 4" x 1/4", 4" x 3/8", 6" x 3/8" and 6" x 1/2

1500 Series - Thermoset Polyester – Olive Green
 1525 Series - Thermoset Polyester Class 1 FR – Slate Gray (Dark Gray)
 1625 Series - Thermoset Vinyl Ester Class 1 FR – Beige

PulTex **SuperStructural** Profiles are identified with imprinted veil.

The following data was derived from ASTM coupon and full section testing. The results are average values based on random sampling and testing of production lots. Composite materials are not homogeneous; and therefore, the location of the coupon extraction can cause variances in the coupon test results. Creative Pultrusions publishes an average value of random samples from production lots.

Property (coupon values)	ASTM Test	Units	1500/1525 Series	1625 Series
Mechanical				
Tensile Strength (LW)	D638	psi	31,000	35,600
Tensile Strength (CW)	D638	psi	16,500	18,900
Tensile Modulus (LW)	D638	10 ⁶ psi	3.5	3.5
Tensile Modulus (CW)	D638	10 ⁶ psi	1.0	1.0
Compressive Strength (LW)	D695	psi	38,800	44,500
Compressive Strength (CW)	D695	psi	25,500	29,000
Compressive Modulus (LW)	D695	10 ⁶ psi	3.0	3.0
Compressive Modulus (CW)	D695	10 ⁶ psi	2.2	2.2
Flexural Strength (LW)	D790	psi	43,500	50,000
Flexural Strength (CW)	D790	psi	24,000	27,500
Flexural Modulus (LW)	D790	10 ⁶ psi	1.9	1.9
Flexural Modulus (CW)	D790	10 ⁶ psi	1.6	1.6
Modulus of Elasticity	Full Section ²	10 ⁶ psi	2.8	2.8
Shear Modulus	Full Section ²	10 ⁶ psi	0.5	0.5
Interlaminar Shear (LW) ⁴	D2344	psi	3,400	3,900
Shear Strength By Punch (PF)	D732	psi	5,500	6,000
Notched Izod Impact (LW)	D256	ft-lbs/in	34	39
Notched Izod Impact (CW)	D256	ft-lbs/in	33	38
Maximum Bearing Strength (LW)	D953	psi	33,000	38,000
Maximum Bearing Strength (CW)	D953	psi	33,000	38,000
Poisson's Ratio (LW)	D3039	in/in	0.35	0.35
Poisson's Ratio (CW)	D3039	in/in	0.12	0.12
In-Plane Shear (LW)	Modified D2344 ³	psi	7,000	7,000
In-Plane Shear (LW) (through heel of angle)	Full Section*	psi	3,400	3,900

*Note: Based on Full Section Connection Test

Additional properties located on page 13

MATERIAL PROPERTIES

PulTex Fiber Reinforced Polymer **SuperStructural** Profiles *Angles*

SuperStructural Angle sizes are: 4" x 1/4", 4" x 3/8", 6" x 3/8" and 6" x 1/2

Property (coupon values)	ASTM Test	Units	1500/1525 Series	1625 Series
Physical				
Barcol Hardness ¹	D2583		45	45
Water Absorption	D570	% Max	0.6	0.6
Density	D792	lbs/in ³	0.060-0.070	0.060-0.070
Specific Gravity	D792		1.66-1.93	1.66-1.93
Coefficient of Thermal Expansion (LW)	D696	10 ⁻⁶ in/in/°F	4.4	4.4
Thermal Conductivity (PF)	C177	BTU-in/ft ² /hr/°F	4	4
Electrical				
Arc Resistance (LW)	D495	seconds	120	120
Dielectric Strength (LW)	D149	KV/in	40	40
Dielectric Strength (PF)	D149	volts/mil	200	200
Dielectric Constant (PF)	D150	@60Hz	5.2	5.2

LW = lengthwise

CW = crosswise

PF = perpendicular to laminate face

¹ PulTex uses a synthetic surface veil that reduces the Barcol Hardness, but does not reflect lack of cure.

² Full section testing based on a 3-point bend simply supported.

³ Follow ASTM D2344, but rotate coupon 90° (cut section of coupon length faces up).

⁴ Tested on a 3:1, span to depth ratio.

Property	ASTM Test	Value	Value
		1525	1625
Flammability Classification	UL94	(VO)	(VO)
Tunnel Test	ASTM E84	25 Max	25 Max
Flammability Extinguishing	ASTM D635	Self extinguishing	Self extinguishing
NBS Smoke Chamber	ASTM E662	650	650

Creative Pultrusions, Inc. believes the information put forth in this property sheet to be as accurate and reliable as of the date of publication. However, we assume no obligation or liability, which may arise as a result of its use. While Creative Pultrusions, Inc. has no knowledge that the information put forth infringes any valid patent, it assumes no responsibility with respect thereto and each user must satisfy oneself that one's intended application process or product infringes no patent.

Procedures For Obtaining Properties

The typical properties listed in this manual were obtained using random samples selected from the production line, in tests performed according to ASTM or other standard procedures. These tests are defined in detail in the referenced standards. A short description is provided herein as an introduction for the designer.

Flexural Properties (ASTM D790)

Flexural strengths are determined by placing a specimen on supports. A center load is applied until failure occurs and the load of failure is the ultimate flexural strength.

Compressive Strength (ASTM D695)

The ultimate compressive strength of a material is the force required to rupture a specimen, calculated to psi values.

Bearing Strength of Plastics (ASTM D953)

This procedure is for determining the ultimate bearing capacity of a specimen. Please note that this procedure is not being used for 4% elongation. Consult Creative Pultrusions, Inc. for 4% hole elongation bearing load numbers.

Tensile Strength (ASTM D638)

A coupon is used to determine the modulus of elasticity of the material based on a ratio of stress and strain.

Izod Impact (ASTM D256)

Impact values are determined by clamping a notched specimen, typically 1-inch, in a testing device, employing a swinging pendulum to apply the force. The amount of force required to break the specimen is then calculated in foot pounds per inch of notch in prepared specimens.

Shear Strength by Punch Tool (ASTM D732)

Shear strength values are obtained by mounting a specimen in a punch-type fixture with a 1-inch diameter punch. The strengths are then determined by force/area.

Barcol Hardness (ASTM D2583)

Barcol hardness is determined by the resistance of a coupon to the indentation of a spring-driven indenter. Reinforced materials will have a wide range of values; therefore, ten readings are taken and the average is reported.

Water Absorption (ASTM D570)

Coupons are immersed in water for twenty-four hours or longer. The percentage of weight increase is then reported as water absorption. This value is important when profiles are to be used in electrical and corrosive applications.

Specific Gravity (ASTM D792)

Specific gravity is the ratio of the weight of a material to an equal amount of water. Specific gravity is important in pricing.

Arc Resistance (ASTM D495)

Arc resistance is a measure of the ability of the laminate to resist the conduction of a high-voltage, low-current charge to arc the surface.

Dielectric Strength (ASTM D149)

Dielectric strength is a measure of a profile as an insulator. Two electrodes are placed on either side of a coupon. If a current passes through the laminate, this constitutes failure. Short-time in oil is the most commonly used method for pultrusion. Longitudinal values are obtained using 1-inch sections and the current is applied parallel to the fiber orientation.

Coefficient of Thermal Expansion - CTE (ASTM D696)

CTE value is obtained by measuring the linear expansion of a coupon in temperature ranges of -30 °C to +30 °C.

Thermal Conductivity (ASTM C177)

The thermal conductivity test is performed using a guarded hot plate. The thermal transmission values of the specimen are then recorded.

The above tests are primarily used for the determination of published physical values.

Weathering (ASTM G53)

The weathering test is very useful for profiles used in outdoor exposures. The test is performed by exposing coupons to artificial weather conditions, simulating the deterioration caused by sunlight and water, as rain or dew. The extent of this test and the results obtained are determined by the end-use application.

Table 3-7 Typical Electrical Properties of PulTex Profiles

Electrical Property	PulTex 1500 1525 & 1625 Series
Dielectric Strength, ASTM D149 (tested perpendicular to laminate face)	7.9 kV/mm
Dielectric Strength, ASTM D149 (tested lengthwise)	1.58 kV/mm
Dielectric Constant, 60 Hz., ASTM D150 (tested perpendicular to laminate face)	5.2
Dissipation Factor 60 Hz., ASTM D150 (tested perpendicular to laminate face)	0.03
Arc Resistance, ASTM-D495 (indicates reported value-measured in longitudinal direction)	120 Seconds

Safety Factors

Because empirical mathematical analysis of strength characteristics of a composite are difficult to predict, reliance on experimentally derived properties has been used. Factors of safety have thus been used to compensate for any uncertainties or variables involved with the composite material.

Current practices have used safety factors from “2” to “10”, depending on the application. When using standard structural profiles, it is common practice to use a safety factor of “3” for shear and “2” for bending. It is acceptable to use a safety factor of “1” for deflection, as full section bending tests can verify the E-Modulus of a particular profile.

Elements Of Sections

The Elements of Section Tables contain the properties of profiles which are stocked or produced from tooling owned by Creative Pultrusions. It is good practice to check on availability before designing from these lists.

The properties were calculated from nominal dimensions. Actual size will vary within the parameters allowed by the ASTM D3917 specification.

Some of the section weights are calculated based on density and slight variances may occur.

Elements of Sections

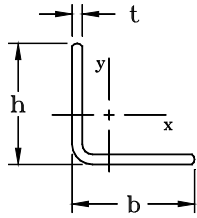

PulTex Equal Leg Angles

Part Number	Depth(h) in	Width(b) in	Thick-ness(t) in	Area in ²	Weight lb/ft	X-X axis or Y-Y axis			
						I in ⁴	S in ³	r in	r _z in
AE120	1.00	1.00	0.125	0.22	0.19	0.021	0.030	0.304	0.182
AE140	1.00	1.00	0.250	0.42	0.20	0.035	0.053	0.286	0.183
AE122	1.50	1.50	0.125	0.35	0.29	0.075	0.071	0.465	0.284
AE130	1.50	1.50	0.1875	0.51	0.43	0.106	0.101	0.455	0.282
AE142	1.50	1.50	0.250	0.67	0.56	0.133	0.129	0.445	0.281
AE220	2.00	2.00	0.125	0.47	0.39	0.186	0.129	0.626	0.386
AE230	2.00	2.00	0.1875	0.70	0.55	0.266	0.187	0.616	0.383
AE240	2.00	2.00	0.250	0.92	0.71	0.338	0.241	0.606	0.381
AE320	3.00	3.00	0.125	0.72	0.59	0.651	0.297	0.949	0.590
AE330	3.00	3.00	0.1875	1.08	0.86	0.947	0.435	0.938	0.587
AE340	3.00	3.00	0.250	1.42	1.17	1.223	0.568	0.927	0.584
AE360	3.00	3.00	0.375	2.09	1.81	1.721	0.815	0.908	0.578
AE440	4.00	4.00	0.250	1.92	1.56	3.002	1.034	1.250	0.787
AE460	4.00	4.00	0.375	2.84	2.32	4.290	1.499	1.230	0.780
AE480	4.00	4.00	0.500	3.72	3.15	5.451	1.934	1.211	0.774
AE640	6.00	6.00	0.250	2.92	2.38	10.491	2.382	1.895	1.194
AE660	6.00	6.00	0.375	4.34	3.57	15.230	3.492	1.874	1.185
AE680	6.00	6.00	0.500	5.72	4.74	19.654	4.552	1.854	1.177

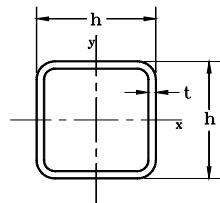

PulTex Square Tubes

Part Number	Width or Depth(h) in	Thick-ness(t) in	Area in ²	Weight lb/ft	X-X axis or Y-Y axis		
					I in ⁴	S in ³	r in
TQ120	1.00	0.125	0.42	0.34	0.05	0.11	0.36
TQ140	1.25	0.250	0.93	0.76	0.16	0.26	0.42
TQ124	1.50	0.125	0.67	0.55	0.21	0.28	0.56
TQ142	1.50	0.250	1.24	1.02	0.33	0.44	0.52
TQ126	1.75	0.125	0.80	0.56	0.35	0.40	0.66
TQ144	1.75	0.250	1.48	1.12	0.57	0.67	0.62
TQ220	2.00	0.125	0.92	0.73	0.53	0.53	0.76
TQ240	2.00	0.250	1.73	1.50	0.89	0.89	0.72
TQ230	2.11	0.190	1.44	1.23	0.89	0.84	0.78
TQ242	2.50	0.250	2.24	1.87	1.90	1.52	0.92
TQ247	2.47	0.220	1.97	1.53	1.67	1.35	0.92
TQ340	3.00	0.250	2.74	2.22	3.47	2.31	1.13
TQ360	3.50	0.375	4.68	3.84	7.71	4.40	1.28
TQ440	4.00	0.250	3.73	3.10	8.75	4.37	1.53
CT045	5.20	0.375	7.00	5.99	26.73	10.28	1.95
TQ660	6.00	0.375	8.48	7.58	44.93	14.98	2.30

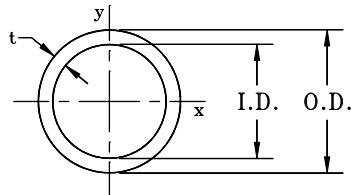

PulTex Round Tubes

Part Number	Outside Diameter (D) in	Inside Diameter (d) in	Thick-ness(t) in	Area in ²	Weight lb/ft	X-X axis		
						I in ⁴	S in ³	r in
TU005	0.75	0.56	.0937	0.19	0.16	0.01	0.03	0.23
TU120	1.00	0.75	0.125	0.34	0.23	0.03	0.07	0.31
TU118	1.25	1.00	.0937	0.34	0.75	0.06	0.09	0.41
TU122	1.25	1.00	0.125	0.44	0.34	0.07	0.11	0.40
TU124	1.50	1.25	0.125	0.54	0.46	0.13	0.17	0.49
TU143	1.50	1.00	0.25	0.98	0.82	0.20	0.27	0.45
TU126	1.75	1.50	0.125	0.64	0.50	0.21	0.24	0.58
TU142	1.75	1.25	0.25	0.91	0.94	0.34	0.39	0.54
TU220	2.00	1.75	0.125	0.73	0.59	0.33	0.33	0.66
TU240	2.00	1.50	0.25	1.37	1.15	0.54	0.54	0.63
TU222	2.50	2.25	0.125	0.93	0.71	0.66	0.53	0.84
TU242	2.50	2.00	0.25	1.77	1.35	1.13	0.91	0.80
TU320	3.00	2.75	0.13	1.13	0.92	1.17	0.78	1.02
TU340	3.00	2.50	0.25	2.16	1.71	2.06	1.37	0.98
TU410	4.02	3.46	0.28	3.24	2.79	5.69	2.84	1.33

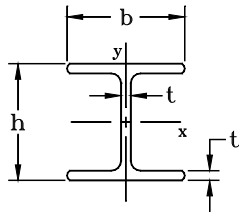

PulTex Wide Flange Sections

Part Number	Depth(h) in	Width(b) in	Thick-ness(t) in	Area in ²	Weight lb/ft	X-X axis			Y-Y axis			Design	
						I	S	r	I	S	r	J	C _w
						in ⁴	in ³	in	in ⁴	in ³	in	in ⁴	in ⁶
IW340	3.00	3.00	0.25	2.17	1.85	3.23	2.15	1.22	1.11	0.74	0.71	0.047	2.49
IW440	4.00	4.00	0.25	2.92	2.86	8.05	4.03	1.66	2.63	1.32	0.95	0.063	10.52
IW640	6.00	6.00	0.25	4.42	3.83	28.58	9.53	2.54	8.91	4.46	1.42	0.094	80.21
IW660	6.00	6.00	0.375	6.57	5.79	40.76	13.59	2.49	13.32	4.44	1.42	0.316	119.84
IW860	8.00	8.00	0.375	8.82	7.77	100.35	25.09	3.37	31.65	7.91	1.90	0.422	506.46
IW880	8.00	8.00	0.50	11.67	10.39	128.81	32.20	3.32	42.09	10.52	1.90	1.000	673.41
IW960	10.00	10.00	0.375	11.07	9.59	200.45	40.09	4.26	61.94	12.39	2.37	0.527	1548.59
IW980	10.00	10.00	0.50	14.67	12.92	259.36	51.87	4.20	82.38	16.48	2.37	1.250	2059.52
IW982	12.00	12.00	0.50	17.67	15.65	457.26	76.21	5.09	142.59	23.77	2.84	1.500	5133.35

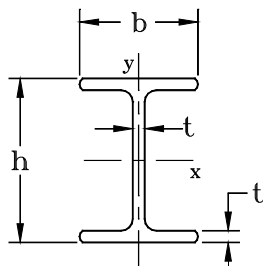

PulTex I-Sections

Part Number	Depth(h) in	Width(b) in	Thick-ness(t) in	Area in ²	Weight lb/ft	X-X axis			Y-Y axis			Design	
						I	S	r	I	S	r	J	C _w
						in ⁴	in ³	in	in ⁴	in ³	in	in ⁴	in ⁶
IB340	3.00	1.50	0.25	1.42	1.22	1.803	1.202	1.178	0.140	0.186	0.314	0.031	0.315
IB440	4.00	2.00	0.25	1.92	1.65	4.530	2.265	1.537	0.329	0.329	0.414	0.042	1.316
IB640	6.00	3.00	0.25	2.92	2.49	16.17	5.39	2.35	1.11	0.74	0.62	0.063	9.99
IB660	6.00	3.00	0.375	4.32	3.67	22.93	7.64	2.31	1.67	1.11	0.62	0.211	15.00
IB860	8.00	4.00	0.375	5.82	5.17	56.71	14.18	3.12	3.95	1.97	0.82	0.281	63.12
IB880	8.00	4.00	0.50	7.67	6.81	72.48	18.12	3.07	5.27	2.63	0.82	0.667	84.26
IB960	10.00	5.00	0.375	7.32	6.43	113.55	22.71	3.94	7.71	3.08	1.03	0.352	192.80
IB980	10.00	5.00	0.50	9.67	8.51	146.45	29.29	3.89	10.27	4.11	1.03	0.833	256.84
IB982	12.00	6.00	0.50	11.67	10.31	258.76	43.13	4.71	17.76	5.92	1.23	1.000	639.33

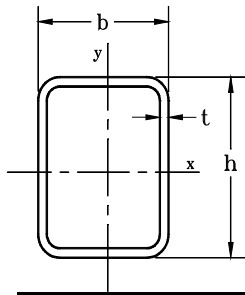

PulTex Rectangular Tubes

Part Number	Depth(h) in	Width(b) in	Thick-ness(t) in	Area in ²	Weight lb/ft	X-X axis			Y-Y axis		
						I in ⁴	S in ³	r in	I in ⁴	S in ³	r in
TR120	0.8	1.165	0.11	0.366	0.3	0.033	0.083	0.300	0.059	0.101	0.402
TR420	4.4	1.43	0.13	1.38	1.1	2.89	1.31	1.45	0.49	0.68	0.59
TR422	4.74	1.72	0.125	1.57	1.36	4.20	1.77	1.64	0.79	0.91	0.71
TR440	4	1.74	0.25	1.74	1.38	3.92	1.96	1.50	0.78	0.90	0.67
TR522	5.08	2	0.125	1.77	1.53	5.75	2.26	1.80	1.20	1.20	0.82
*TR620	6	2	0.125	2.39	1.92	9.34	3.11	1.98	1.61	1.61	0.82
TR640	6	4	0.25	4.62	3.87	22.31	7.44	2.20	11.84	5.92	1.61
TR740	7	4	0.25	5.2	4.09	33.61	9.61	2.54	13.91	6.95	1.64
TR760	7	4	0.375	7.63	6.21	47.58	13.60	2.50	19.25	9.63	1.59
TR842	8	4	0.25	5.7	4.7	46.80	11.70	2.87	15.67	7.83	1.66
TR860	8	4	0.375	8.38	6.71	66.63	16.66	2.82	21.73	10.86	1.61

*Contains internal webs

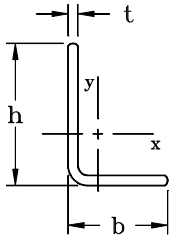

PulTex Unequal Leg Angles

Part Number	Depth(h) in	Width(b) in	Thick-ness(t) in	Area in ²	Weight lb/ft	X-X axis			Y-Y axis		
						I in ⁴	S in ³	r in	I in ⁴	S in ³	r in
AU122	1.5	1.0	0.125	0.29	0.23	0.065	0.066	0.477	0.024	0.032	0.288
AU220	2.0	1.0	0.125	0.35	0.22	0.144	0.114	0.643	0.026	0.033	0.271
AU230	2.0	1.0	0.1875	0.51	0.40	0.206	0.165	0.633	0.035	0.046	0.262
AU240	2.0	1.0	0.25	0.67	0.53	0.261	0.212	0.623	0.043	0.059	0.254
AU320	3.0	1.0	0.125	0.47	0.36	0.365	0.209	0.851	0.112	0.089	0.472
AU242	2.0	1.3	0.25	0.73	0.58	0.285	0.222	0.623	0.085	0.093	0.340
AU222	2.0	1.5	0.125	0.41	0.37	0.168	0.123	0.640	0.083	0.073	0.449
AU244	2.0	1.5	0.25	0.8	0.63	0.305	0.230	0.619	0.146	0.135	0.429
AU322	3.0	1.5	0.125	0.54	0.39	0.440	0.244	0.964	0.028	0.034	0.243
AU330	3.0	1.5	0.1875	0.8	0.57	0.511	0.264	0.977	0.092	0.077	0.415
AU224	2.6	1.6	0.125	0.5	0.39	0.334	0.224	0.715	0.121	0.107	0.429
AU332	3.0	2.0	0.1875	0.89	0.70	0.957	0.505	0.956	0.164	0.142	0.396
AU342	3.0	2.0	0.25	1.17	0.91	0.825	0.408	0.963	0.301	0.197	0.582
AU360	3.0	2.0	0.375	1.71	1.33	1.064	0.532	0.953	0.383	0.255	0.572
AU440	4.0	2.0	0.25	1.42	1.15	1.493	0.762	0.934	0.526	0.360	0.554
AU460	4.0	2.0	0.375	2.09	1.74	2.362	0.922	1.289	0.413	0.263	0.539
AU442	4.0	3.0	0.25	1.67	1.37	3.359	1.333	1.269	0.568	0.373	0.522
AU462	4.0	3.0	0.375	2.46	2.10	2.730	0.989	1.278	1.335	0.590	0.894
AU580	5.0	3.5	0.50	3.97	2.96	3.894	1.434	1.258	1.882	0.848	0.874
AU660	6.0	4.0	0.375	3.59	3.04	9.183	2.240	1.947	0.378	1.088	1.181
AU680	6.0	4.0	0.50	4.72	3.87	13.311	3.280	1.926	4.835	1.580	1.161
AU961	10.0	5.0	0.375	5.46	4.47	58.286	8.941	3.267	10.435	2.594	1.382

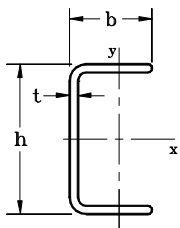

PulTex Channels

Part Number	Depth(h) in	Width(b) in	Thick-ness(t) in	Area in ²	Weight lb/ft	X-X axis			Y-Y axis		
						I in ⁴	S in ³	r in	I in ⁴	S in ³	r in
CH130	1.50	1.00	.1875	0.55	0.45	0.167	0.222	0.551	0.048	0.076	0.297
CH222	2.00	0.56	.125	0.34	0.30	0.164	0.164	0.692	0.007	0.018	0.147
CH224	2.75	1.00	.125	0.56	0.45	0.586	0.426	1.024	0.046	0.061	0.286
CH340	3.00	.875	.25	1.00	0.81	1.018	0.678	1.011	0.050	0.080	0.223
CH330	3.00	1.00	.1875	0.83	0.72	0.945	0.630	1.068	0.062	0.086	0.275
CH342	3.00	1.50	.25	1.31	1.04	1.611	1.074	1.110	0.255	0.248	0.441
CH420	4.00	1.06	.125	0.71	0.60	1.456	0.728	1.431	0.060	0.072	0.290
CH434	4.00	1.75	.1875	1.10	0.90	2.850	1.425	1.607	0.333	0.275	0.550
CH440	4.00	1.13	.25	1.37	1.07	2.628	1.314	1.384	0.118	0.142	0.293
CH450	4.50	2.50	.25	2.18	1.81	6.666	2.962	1.748	1.294	0.742	0.770
CH540	5.00	1.38	.25	1.75	1.40	5.385	2.154	1.756	0.231	0.223	0.364
CH640	6.00	1.63	.25	2.12	1.75	9.611	3.204	2.129	0.402	0.323	0.435
CH662	6.00	1.69	.375	3.10	2.61	13.427	4.476	2.081	0.621	0.503	0.447
CH740	7.00	2.00	.25	2.57	2.03	16.420	4.692	2.530	0.794	0.517	0.556
CH840	8.00	2.19	.25	2.91	2.42	24.300	6.075	2.890	1.068	0.628	0.606
CH860	8.00	2.19	.375	4.23	3.57	33.751	8.437	2.826	1.470	0.890	0.590
CH922	10.00	2.75	.125	1.88	1.55	25.885	5.177	3.706	1.180	0.534	0.791
CH980	10.00	2.75	0.50	7.01	5.94	86.876	17.375	3.519	3.828	1.855	0.739
CH995	11.50	2.75	0.50	7.78	6.69	124.581	21.666	4.001	4.054	1.930	0.722
CH800	14.00	6.00	0.50	12.17	10.41	349.085	49.869	5.357	40.762	9.273	1.831
CH810	18.00	2.50	0.25	5.56	4.86	204.772	22.752	6.070	1.840	0.865	0.575
CH990	24.00	3.00	.25	7.33	5.89	475.404	39.617	8.054	3.374	1.300	0.679
CH994	24.00	4.00	0.47	14.52	11.88	985.090	82.090	8.237	13.710	4.143	0.972

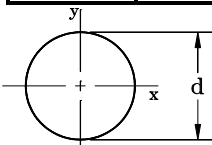

PulTex Solid Round Rods

Part Number	Diameter(d) in	Area in ²	Weight lb/ft	X-X axis or Y-Y axis		
				I in ⁴	S in ³	r in
SO004	.25	0.049	0.43	<0.001	0.002	0.063
SO006	.375	0.110	0.94	0.001	0.005	0.094
SO008	.50	0.196	0.17	0.003	0.012	0.125
SO010	.625	0.307	0.27	0.008	0.024	0.156
SO012	.75	0.442	0.39	0.016	0.041	0.188
SO016	1.00	0.785	0.69	0.049	0.098	0.250
SO020	1.25	1.227	1.07	0.120	0.192	0.313
SO024	1.50	1.767	1.48	0.249	0.331	0.375
SO032	2.00	3.142	2.75	0.785	0.785	0.500

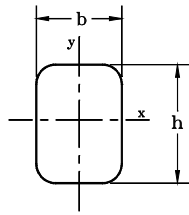

PulTex Solid Bars

Part Number	Depth(h) in	Width(b) in	Area in ²	Weight lb/ft	X-X axis			Y-Y axis		
					I in ⁴	S in ³	r in	I in ⁴	S in ³	r in
SQ040	0.25	0.25	0.06	0.05	< .001	0.002	0.07	< .001	0.002	0.07
SQ011	1.00	1.00	0.99	0.85	0.080	0.161	0.285	0.080	0.161	0.285
SQ020	1.23	1.23	1.51	1.28	0.189	0.306	0.354	0.189	0.306	0.354
SQ024	1.46	1.46	2.12	1.80	0.373	0.510	0.419	0.373	0.510	0.419

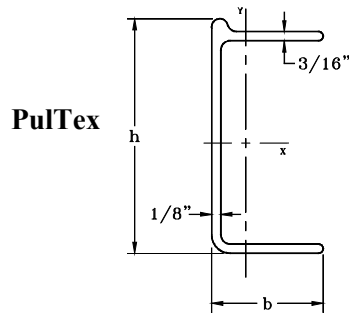

Sludge Flights

Part Number	Depth(h) in	Width(b) in	Area in ²	Weight lb/ft	X-X axis			Y-Y axis		
					I in ⁴	S in ³	r in	I in ⁴	S in ³	r in
SF011	6.00	2.50	1.64	1.48	7.81	2.77	2.18	1.02	0.58	0.79
SF021	8.00	2.50	1.87	1.68	15.59	4.11	2.88	1.11	0.60	0.77

Chapter 4 Load Tables for Flexural Members and Connections

Beam Deflections - A pultruded beam will be designed for deflection, strength and buckling.

Fiber reinforced composite beams exhibit both flexural and shear deflections. Shear deflections are most apparent when the spans to depth ratios are less than 20. At short spans, the shear deflections comprise a significant portion of the actual deflections; therefore, the designer should always account for shear deflections when designing with composites. Reference PulTex Fiber Reinforced Polymer Structural Profiles Material Properties Sheets for the appropriate properties of the profiles for which you are utilizing in your design.

Although coupon testing is a good quality control method, composite materials are not homogeneous and will exhibit different properties in the web and flange areas. Deflection predictions should be made with values based on full section testing. Please reference Appendix B per ASTM D198 for full section testing procedure.

The Allowable Uniform Load Tables were calculated using physical properties that were derived from full section testing. The Load Tables are based on **simply supported end conditions with uniformly distributed loads**. For beam loadings and end conditions not represented in the Allowable Uniform Load Tables, reference the Beam Deflection Formula and relative design tables.

The following formula was used to predict the deflections in The Allowable Uniform Load Tables:

$$\Delta = \frac{5wL^4}{384 EI} + \frac{w L^2}{8A'G} \quad \text{Where:}$$

A_w = Shear area of profile (in²) (Ref. Table 2)
 k = Shear coefficients (Ref. Table 2)
 E_x = Modulus of elasticity (psi)
 G = Modulus of rigidity (Shear Modulus) (psi)
 I = Moment of inertia (in⁴)
 L = Length of span (in)
 Δ = Deflection (in)
 w = Load on the beam (lbs./in)

Allowable Stresses

Fiber reinforced composite beams exhibit compressive, flexural, and shear stresses under various load conditions. The dominating failure mode for long span flexural members is typically local buckling of the compressive flange, while short spans are dominated by in-plane shear failures.

Safety Factors

The allowable stresses used in The Allowable Uniform Load Tables are based on the ultimate compressive buckling, flexural and shear strengths with applied safety factors. Specifically, a “2.5” safety factor is used for local buckling and flexural stresses while a “3” safety factor is used for shear. The following shear and flexure formula were used to predict the Allowable Loads.

$$V = f_v(A_w); \text{ where } f_v = \text{allowable shear stress} = 7,000/3 = 2,333 \text{ psi (Equation P-4)}$$

$$M = f_b(S_x); \text{ where } f_b = \text{allowable flexural stress} = 33,000/2.5 = 13,200 \text{ psi (Equation P-5)}$$

Local Buckling of the Compression Flange for Wide Flange, I-Sections, Square Tube and Rectangular Tube Sections

The local compression buckling strength of pultruded wide flange, I-Sections, square tubes and rectangular tubes can be determined by utilizing the following equations. The local buckling equations were derived from University research. (Reference Step by Step Design Equations for Fiber-reinforced Plastic Beams for Transportation Structures)Davalos,Barbero and Qiao

$$\sigma_x^{cr} = \frac{\pi^2}{12} \left(\frac{t_f}{b} \right)^2 \left[\sqrt{q} \left(2 \sqrt{(E_x)_f (E_y)_f} \right) + p \left((E_y)_f (v_{xy})_f + 2(G_{xy})_f \right) \right] \quad (\text{Equation P-3})$$

Where, σ_x is the critical stress, and p and q are constants that are defined by the coefficient of restraint (ζ) at the junction of the plates:

I/W sections:

$$p = 0.3 + \left(\frac{0.004}{\zeta - 0.5} \right); q = 0.025 + \left(\frac{0.065}{\zeta + 0.4} \right); \zeta = \frac{2b_w (E_y)_f}{b_f (E_y)_w}; b = \frac{b_f}{2}$$

Box sections:

$$p = 2.0 + \left(\frac{0.002}{\zeta - 1.3} \right); q = 1.0 + \left(\frac{0.08}{\zeta + 0.2} \right); \zeta = \frac{b_w (E_y)_f}{b_f (E_y)_w}; b = b_f$$

Where:

- σ_x^{cr} = Critical buckling stress in (psi)
- b = Half the width of the compression flange for I/W sections (in)
- b = The width of the compression flange for box sections, $b=b_f$ (in)
- b_f = Width of the compression flange (in)
- b_w = Height of the section (in)
- E_x = Longitudinal modulus of elasticity (psi)
- E_y = Transverse modulus of elasticity (psi)
- f = Flange
- G_{xy} = Modulus of rigidity (Shear Modulus) (psi)
- p = Constant defined by the coefficient of restraint (ζ)
- q = Constant defined by the coefficient of restraint (ζ)
- t = Thickness of the compression flange (in)
- ζ = Coefficient of restraint of the compression plates
- w = Web

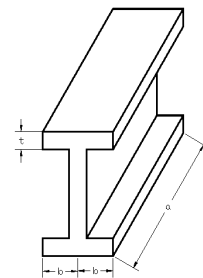
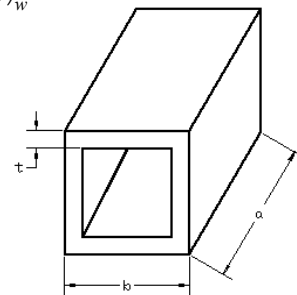

Lateral-Torsional Buckling

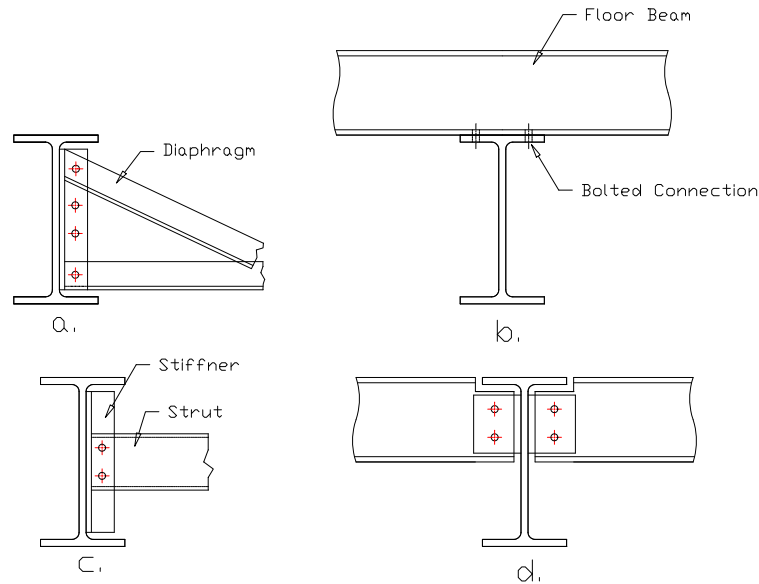

The Allowable Uniform Loads in the Allowable Uniform Load Tables are derived assuming that adequate lateral support is provided for the flexural members. The degree of lateral support for structures is difficult to predict. Figures a.– d. represent common bracing scenarios that are considered to provide adequate lateral support. Note that the bracing intervals must be adequate. In the event that lateral support is not used, the designer must investigate lateral torsional buckling criteria. The Allowable Uniform Load Tables contain a column titled Allowable load, laterally unsupported beam global buckling capacity. Please note that the global buckling load tables include a 2.5x safety factor.

For I-Sections or Wide Flange Sections, the lateral torsional buckling load for various loading conditions can be determined by using the following equation:

Design Equation for Lateral-Torsional Buckling

$$M_{cr} = C_b \frac{\pi}{KL_b} \sqrt{\left(\frac{\pi E_y}{KL_b}\right)^2 C_w I_y + E_y I_y G J} \quad (\text{Equation P-1})$$

Where, for Wide Flange Sections and I-Sections

$$C_w = \frac{h^2 I_y}{4}$$

$$J = \frac{1}{3} (2bt_f^3 + ht_w^3)$$

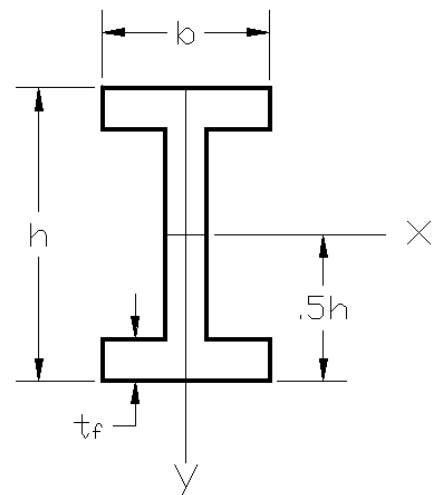

- C_w = Warping constant (in⁶)
- J = Torsion constant (in⁴)
- C_b = Moment variation constant (Ref. Table 4-1)
- M_{cr} = Critical moment (in-lbs.)
- L_b = Unsupported length between points that have lateral restraint (in)
- E_y = Modulus of elasticity for bending about minor axis y-y (psi)
(Use same value as E_x , for simplicity. Values are very similar) $E_y \approx E_x$
- G = Shear modulus (psi)
- K = Effective length coefficient (Ref. Table 4-1)
- I_y = Moment of Intertia about the minor axis

C_b is a moment gradient adjuster, that depends on the type of load and end restraint conditions. Values for C_b can be located in Table 4-1.

Table 4-1
Lateral Buckling Coefficient for Various End Conditions¹

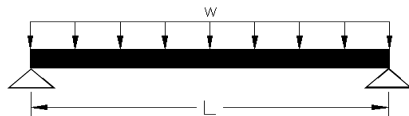
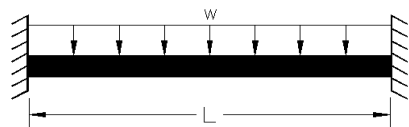
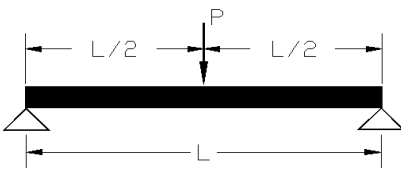
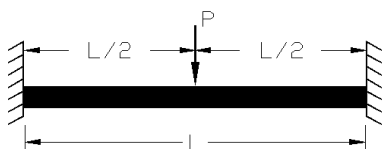
Lateral Support about y-axis	Moment gradient adjuster (C_b)	Effective length coefficient (K)
	None	1.0
	None Full	1.0 0.5
	None Full	1.0 0.5
	None Full	1.0 0.5
	None Full	1.0 0.5

Stress Calculations for Channels

INTRODUCTION

Channel sections are used extensively in composite structures. Due to the fact that channel sections are rarely, if ever loaded through the shear center (see Figure 1), a firm understanding of the behavior of loaded channels must be understood. The following design equations were developed based on combined experimental, analytical and numerical study of five FRP channel sections, which are representative of the shapes currently used in practice. The information gained from the five channel sections was used to derive the local and lateral buckling loads for all of the channel sections produced by CPI.

The five beams studied include the following channels 4"x1-1/8"x1/4", 6"x1-5/8"x1/4", 6"x1-11/16"x3/8", 8"x2-3/16"x3/8", 10"x2-3/4"x1/2". All the five channel sections were analyzed, and the developed analytical solutions and design formulas were compared with the commercial finite element modeling using ANSYS (Qiao 2003).

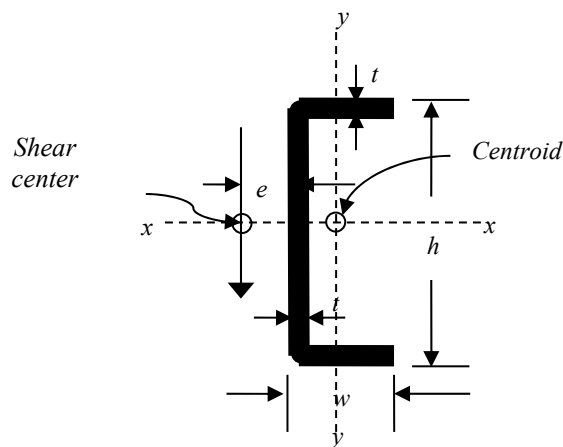

Figure 1 FRP channel shapes

Local Buckling of FRP Channels

A variational formulation of Ritz method (Qiao and Zou 2002; Qiao and Zou 2003) was used to establish an eigenvalue problem, and the flange and web critical local buckling coefficients were determined. In the local buckling analysis, the panels of FRP channel shapes were simulated as discrete laminated plates or panels (Figure 2) (Qiao et al. 2001), and the effects of restraint at the flange-web connection are considered. The flange of pultruded FRP channel sections were modeled as a discrete panel with elastic restraint at one unloaded edge and free at the other unloaded edge (restrained-free (RF) condition) and subjected to uniform distributed axial in-plane force along simply supported loaded edges; whereas for the web, the panel is modeled as a discrete plate with equal elastic restraints at two unloaded edges (restrained-restrained (RR) condition) (Figure 2b).

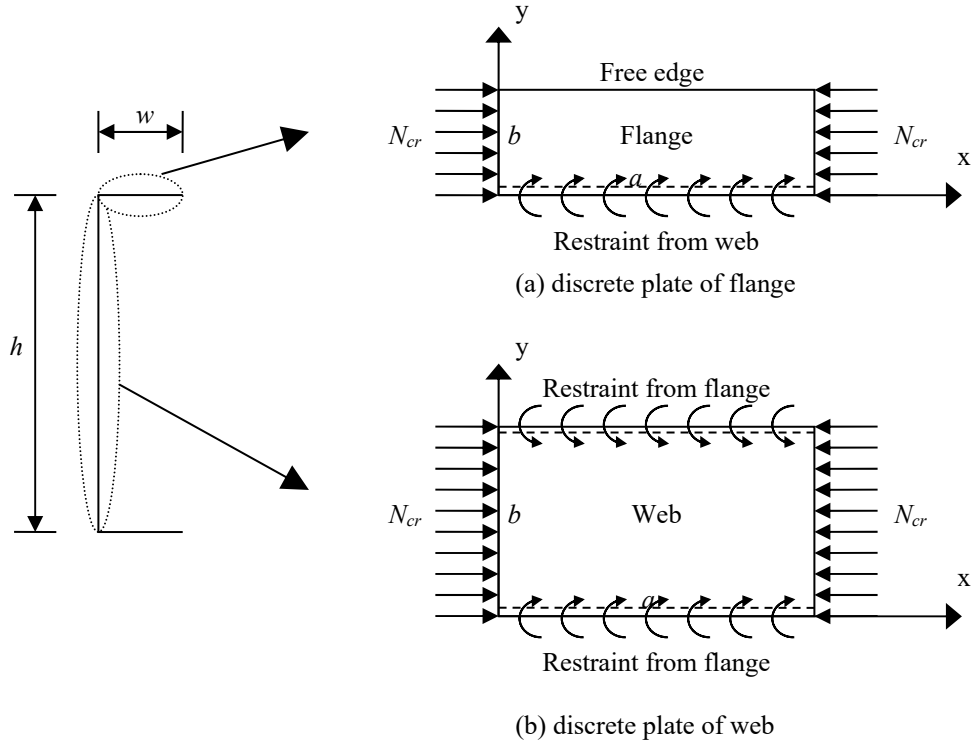

Figure 2 Modeling of Local Buckling of FRP Channel Shapes

For the flange panels under compression, the formula of plate local buckling strength, $(N_x)_{cr}$, with elastically restrained at one unloaded edge and free at the other (Figure 2a) is given as (Qiao and Zou 2003)

$$(N_x)_{cr} = \frac{t^3}{12b_f^2(6+15\xi+10\xi^2)} \left[-20(2+3\xi)E_y\nu_{xy} + 15.49\sqrt{(2+\xi)}\sqrt{(6+15\xi+10\xi^2)}\sqrt{E_xE_y} + 40(4+6\xi+3\xi^2)G_{xy} \right] \quad (1)$$

where, E_x , E_y , G_{xy} and ν_{xy} are the material properties of the channel sections. t and b_f are the thickness and width of the flange; ξ is the coefficient of restraint for flange-web connection and is given as

$$\xi = \frac{b_w}{b_f} \frac{1}{1 - \frac{6(b^w)^2 G_{xy}}{\pi^2 (b^f)^2 (\sqrt{E_x E_y} + E_y \nu_{xy} + 2G_{xy})}} \quad (2)$$

where b_w is the width of the web panel (Figure 2). The critical aspect ratio ($\gamma = a/b$, where a is the length of the panel) of the flange panel is defined as

$$\gamma_{cr} = 1.1287m \left\{ \frac{\xi(10\xi^2 + 18\xi + 9)E_x}{(\xi^2 + 2)E_y} \right\}^{\frac{1}{4}} \quad (3)$$

where m is the number of buckling half waves.

Thus, the critical stress due to the local buckling of the channel can be computed as

$$\sigma_{cr} = \frac{(N_x)_{cr}}{t} \quad (4)$$

The explicit formulas for the critical aspect ratio ($\gamma = a/b$, where $a =$ length and $b =$ width) are also given in Equation (3). From Equation (3), the desirable locations of restraint supports or bracings can be obtained. Based on the critical aspect ratios for local buckling, the number and locations of restraint (or lateral) supports can be recommended and properly designed.

Lateral Buckling of FRP Channels



Figure 3 Experimental testing for lateral buckling of FRP channel shapes

Since two back-to-back channels have similar behavior of I-section, the lateral buckling behavior of a single channel may be similar to the one of I-section; however, the applied load in the channel section must be acted at the shear center of the channel section (see Figure 1). For uniform FRP channel section (i.e., both the web and flanges have the same material properties and thickness), the shear center (e in Figure 1) can be simply defined as (Boresi and Schmidt 2003):

$$e = \frac{3b_f^2}{b_w + 6b_f} \text{ or } = \frac{3w^2}{h + 6w} \quad (5)$$

where $b_f (= w)$ and $b_w (= h)$ are the widths of flange and web, respectively (Figure 1).

For long-span FRP channel beams without lateral supports and with relatively large slenderness ratios, lateral buckling is prone to happen. Based on Vlasov's theory (Pandey et al. 1995), a simplified engineering equation for lateral buckling of an "I" section is adapted for prediction of lateral buckling of channel section. The lateral buckling of channel sections under a tip load (cantilever beam) through the shear center is approximated as:

$$P_{cr} = \gamma \sqrt{\frac{E_x I_{yy} JG}{L^2}} \quad (6)$$

where

$$\gamma = 5.08 \sqrt{1 + \frac{19.3}{\kappa} \left[\frac{(\kappa + 13)(\kappa + 3)}{(\kappa + 10)^2} \right]}$$

$$\kappa = \frac{JGL^2}{I_{ww}}$$

$$JG = \frac{2(G_{xy})_f t_f^3 b_f}{3} + \frac{(G_{xy})_w t_w^3 b_w}{3}$$

$$I_{ww} = \frac{(E_x)_f t_f b_w^2 b_f^3}{24} + \frac{(E_x)_f t_f^3 b_f^3}{36} + \frac{(E_x)_w t_w^3 b_w^3}{144}$$

and I_{yy} is the moment of inertial of the channel section along the weak axis.

The P_{cr} or tip load applied through the shear center that causes the channel to lateral buckle can be related back to a moment applied to the beam. The moment relation can be used to predict the lateral buckling capacity of channel sections for any given load scenario. The buckling loads derived from Equation (5) were characterized for all the channel sections offered by CPI.

Master Design Curves

Based on the design formulas and critical loads for local buckling and global (lateral) buckling, a master design chart for stability of FRP channel beams was developed. The master design curve provides the relationship between moment capacity and unbraced length.

The moment capacity can be utilized for channel beams with various end conditions and load scenarios. The moment charts are based on equation (6):

$$M_{cr} = P_{cr} L \quad (7)$$

where the maximum load P_{cr} was determined from the cantilever beam loadings. The ultimate local buckling moment is also applied to the charts. The ultimate local buckling moment should always be evaluated against the ultimate lateral or global buckling capacity. Corresponding to the lateral or global buckling, the critical stress can be defined as

$$\sigma_{cr} = \frac{M_{cr} h}{I_{xx} 2} \quad (8)$$

where I_{xx} is the moment of inertial of the channel section along the strong axis (Figure 1), and h is the height of the channel.

To facilitate the design of stability of FRP channel sections, a step-by-step design guideline is recommended as follows:

1. Obtain the channel material properties from the Channel Material Property Sheets.
2. Use Eq. (1) to predict the local buckling strength of flange.
3. Predict the global (lateral) buckling of channel sections using Eq. (6).

Obtain the critical stress of the channel using Eq. (4) or (8) based on the mode of buckling (either local or lateral buckling).

4. Determine the shear capacity based on Equation P-4.
5. Determine the flexural capacity based on Equation P-5.

To simplify the complex equations, reference Local and Global Buckling of FRP Channels Equation Solutions spreadsheet on the following page. For information on Ultimate Moment Capacity versus Lateral Restraint, reference graphs in Uniform Load Table Section.

Please reference Example 4 and 5 of the Examples Section for details on how to use the channel load tables.

Local and Global Buckling of FRP Channels

Part# CH340 3" x 7/8" x 1/4"

t	0.25	ξ	21.5180	I_{yy}	0.0495
bw	3	n1	-465878835	γ	6.1895
bf	0.875	n2	9162437283	κ	35.9709
H	3	n3	3.0444E+10	JG	12369.7917
L	24	Ncr	13,423	I_{ww}	198,077
		γ_{cr}	5.8011	I_{xx}	1.0181

Part# CH342 3" x 1-1/2" x 1/4"

t	0.25	ξ	3.3030	I_{yy}	0.2545
bw	3	n1	-83363686.6	γ	8.0666
bf	1.5	n2	792774089	κ	9.3516
H	3	n3	1130965423	JG	15625
L	24	Ncr	6,469	I_{ww}	962,402
		γ_{cr}	3.8565	I_{xx}	1.6106

Part# CH440 4" x 1-1/8" x 1/4"

t	0.25	ξ	13.8450	I_{yy}	0.1163
bw	4	n1	-304744205	γ	7.4907
bf	1.12	n2	4929454298	κ	12.9081
H	4	n3	1.3242E+10	JG	16250
L	24	Ncr	8,705	I_{ww}	725,127
		γ_{cr}	5.2454	I_{xx}	2.6197

Part# CH540 5" x 1-3/8" x 1/4"

t	0.25	ξ	11.9570609	I_{yy}	0.2392
bw	5	n1	-265098279	γ	10.7978971
bf	1.375	n2	4028140115	κ	3.1513253
H	5	n3	1.0093E+10	JG	20182.2917
L	18	Ncr	5,909	I_{ww}	2,075,020
		γ_{cr}	5.07661682	I_{xx}	5.4233

Part# CH640 6" x 1-5/8" x 1/4"

t	0.25	ξ	10.7162	I_{yy}	0.4021
bw	6	n1	-239040145	γ	11.1573204
bf	1.625	n2	3469540947	κ	2.82973134
H	6	n3	8256156885	JG	24088.5417
L	24	Ncr	4,307	I_{ww}	4,903,292
		γ_{cr}	4.9554	I_{xx}	9.6207

Part# CH662 6" x 1-11/16" x 3/8"

t	0.375	ξ	14.4455	I_{yy}	0.6213
bw	6	n1	-317355211	γ	9.1504
bf	1.688	n2	5228598198	κ	5.6677
H	6	n3	1.4334E+10	JG	82406.25
L	24	Ncr	12,852	I_{ww}	8,374,797
		γ_{cr}	5.2957	I_{xx}	13.4285

Part# CH740 7" x 2" x 1/4"

t	0.25	ξ	16.8153185	I_{yy}	0.7944
bw	7	n1	-367121688	γ	14.3667987
bf	2	n2	6464727906	κ	1.33364906
H	7	n3	1.9063E+10	JG	28645.8333
L	24	Ncr	2,654	I_{ww}	12,372,070
		γ_{cr}	5.48116546	I_{xx}	16.4203

Part# CH840 8" x 2-3/16" x 1/4"

t	0.25	ξ	11.4811	I_{yy}	1.069
bw	8	n1	-255103569	γ	16.8423
bf	2.188	n2	3810621431	κ	0.8786
H	8	n3	9366704901	JG	32229.1667
L	24	Ncr	2,349	I_{ww}	21,129,723
		γ_{cr}	5.0312	I_{xx}	24.3035

Part# CH860 8" x 2-3/16" x 3/8"

t	0.375	ξ	11.4811	I_{yy}	1.4698
bw	8	n1	-255103569	γ	9.8023
bf	2.188	n2	3810621431	κ	4.4008
H	8	n3	9366704901	JG	108773.438
L	36	Ncr	7,927	I_{ww}	32,032,657
		γ_{cr}	5.0312	I_{xx}	33.7508

Part# CH955 11-1/2" x 2-3/4" x 1/2"

t	0.5	ξ	5.7704	I_{yy}	4.0538
bw	11.5	n1	-135179215	γ	11.4456
bf	2.75	n2	1542776744	κ	2.60682271
H	11.5	n3	2770330492	JG	354166.667
L	36	Ncr	13,523	I_{ww}	176,076,416
		γ_{cr}	4.3403	I_{xx}	124.5807

Part# CH980 10" x 2-3/4" x 1/2"

t	0.5	ξ	68.3375	I_{yy}	3.8279
bw	10	n1	-2173631139	γ	10.0450
bf	2.75	n2	6.5032E+10	κ	4.0350
H	10	n3	2.8848E+11	JG	322916.667
L	44	Ncr	10,139	I_{ww}	154,934,814
		γ_{cr}	7.1785	I_{xx}	86.876

Part# CH994 24" x 4" x 1/2"

t	0.472	ξ	2.3525	I_{yy}	13.7
bw	24	n1	-63402801.2	γ	23.2843
bf	4	n2	550224952	κ	0.4068
H	24	n3	694361146	JG	560821.589
L	40	Ncr	6,695	I_{ww}	2,205,821,187
		γ_{cr}	3.5687	I_{xx}	985

Beam Deflection Formula

Uniform load on simple beam

$$\begin{aligned} \text{Total Equiv. Uniform Load} &= wl \\ \Delta_{\text{max. (at midpoint)}} &= \frac{5wl^4}{384EI} + \frac{wl^2}{8GA'} \\ \Delta_x &= \frac{wx}{24EI} (l^3 - 2lx^2 + x^3) \\ R \text{ is } V &= \frac{wl}{2} \\ V_x &= w \left(\frac{l}{2} - x \right) \\ M_{\text{max. (at midpoint)}} &= \frac{wl^2}{8} \\ M_x &= \frac{wx}{2} (l - x) \end{aligned}$$

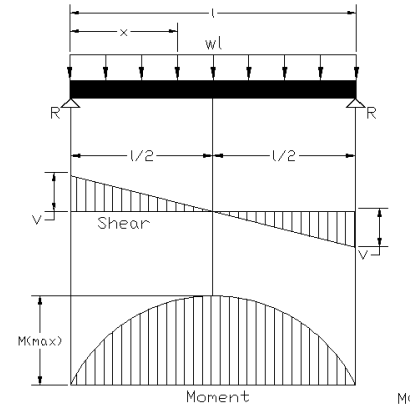

Note: Reference Table 4-2. Shear Areas and Shear Coefficients for Various Cross Sections A' , $A' = kA_w$.

Uniform load on beam fixed at both ends

$$\begin{aligned} \text{Total Equiv. Uniform Load} &= \frac{2wl}{3} \\ \Delta_{\text{max. (at midpoint)}} &= \frac{wl^4}{384EI} + \frac{wl^2}{8GA'} \\ \Delta_x &= \frac{wx^2}{24EI} (l^2 - x^2) \\ R \text{ is } V &= \frac{wl}{2} \\ V_x &= w \left(\frac{l}{2} - x \right) \\ M_{\text{max. (at ends)}} &= \frac{wl^2}{12} \\ M_l \text{ (at midpoint)} &= \frac{wl^2}{24} \\ M_x &= \frac{w}{12} (6lx - l^2 - 6x^2) \end{aligned}$$

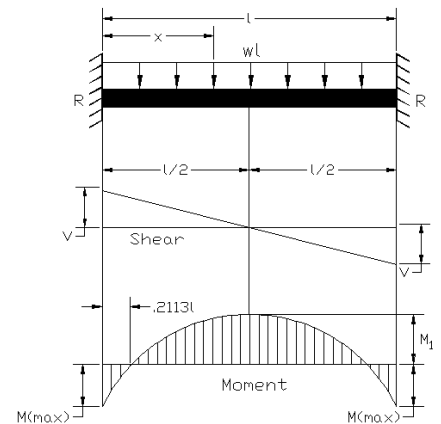

Point load on simply supported beam

$$\begin{aligned} \text{Total Equiv. Uniform Load} &= 2P \\ \Delta_{\text{max. (at point of load)}} &= \frac{Pl^3}{48EI} + \frac{Pl}{4GA'} \\ \Delta_x \left(\text{when } x < \frac{l}{2} \right) &= \frac{Px}{48EI} (3l^2 - 4x^2) \\ V &= \frac{P}{2} \\ M_{\text{max. (at point of load)}} &= \frac{Pl}{4} \\ M_x \left(\text{when } x < \frac{l}{2} \right) &= \frac{Px}{2} \end{aligned}$$

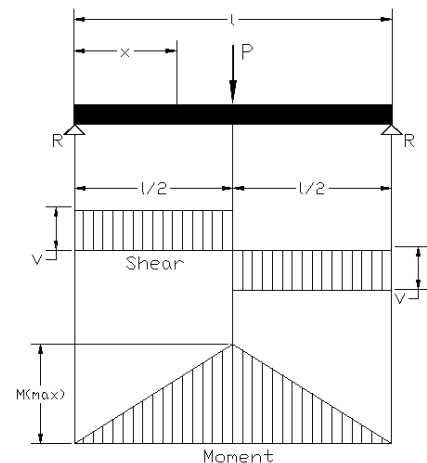

Point load on beam with fixed ends

$$\begin{aligned}
 \text{Total Equiv. Uniform Load} &= P \\
 \Delta_{\text{max. (at midpoint)}} &= \frac{Pl^3}{192 EI} + \frac{Pl}{4 GA'} \\
 \Delta_x \left(\text{when } x < \frac{l}{2} \right) &= \frac{Px^2}{48 EI l^2} (3l - 4x) \\
 V &= \frac{P}{2} \\
 M_{\text{max. (at center and ends)}} &= \frac{Pl}{8} \\
 M_x \left(\text{when } x < \frac{l}{2} \right) &= \frac{P}{8} (4x - l)
 \end{aligned}$$

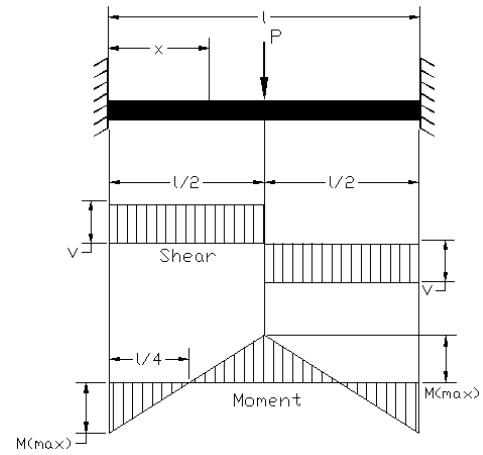

Point load on cantilever beam

$$\begin{aligned}
 \text{Total Equiv. Uniform Load} &= 8P \\
 \Delta_{\text{max. (at free end)}} &= \frac{Pl^3}{3 EI} + \frac{Pl}{GA'} \\
 \Delta_x &= \frac{P}{6 EI} (2l^3 - 3l^2x + x^3) \\
 R \text{ is } V &= P \\
 M_{\text{max. (at fixed end)}} &= Pl \\
 M_x &= Px
 \end{aligned}$$

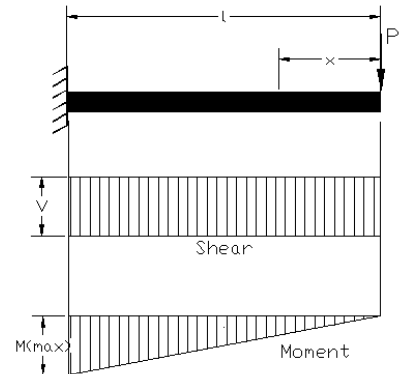

Uniform load on cantilever beam

$$\begin{aligned}
 \text{Total Equiv. Uniform Load} &= 4wl \\
 \Delta_{\text{max. (at free end)}} &= \frac{wl^4}{8 EI} + \frac{wl^2}{2 GA'} \\
 \Delta_x &= \frac{w}{24 EI} (x^4 - 4l^3x + 3l^4) \\
 R \text{ is } V &= wl \\
 V_x &= wx \\
 M_{\text{max. (at fixed end)}} &= \frac{wl^2}{2} \\
 M_x &= \frac{wx^2}{2}
 \end{aligned}$$

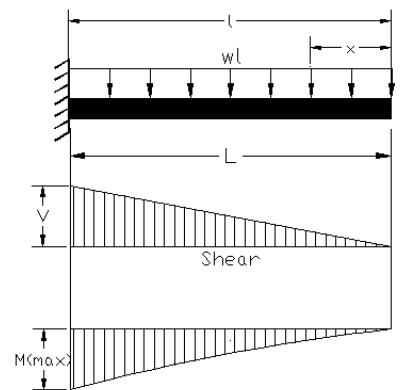

Two Concentrated Loads Equally Spaced on a Simply Supported Beam

$$\begin{aligned} \text{Total Equiv. Uniform Load} &= \frac{8 Pa}{l} \\ \Delta_{\text{max. (at center)}} &= \frac{Pa}{EI} \left(\frac{l^2}{8} - \frac{a^2}{6} \right) + \frac{Pa}{GA'} \\ \Delta_x \text{ (when } x < a) &= \frac{Px}{6 EI} (3la - 3a^2 - x^2) \\ \Delta_x \text{ (when } x > a \text{ and } < (l-a)) &= \frac{Pa}{6 EI} (3lx - 3x^2 - a^2) \\ R \text{ is } V &= P \\ M \text{ max. (between loads)} &= Pa \\ M_x \text{ (when } x < a) &= Px \end{aligned}$$

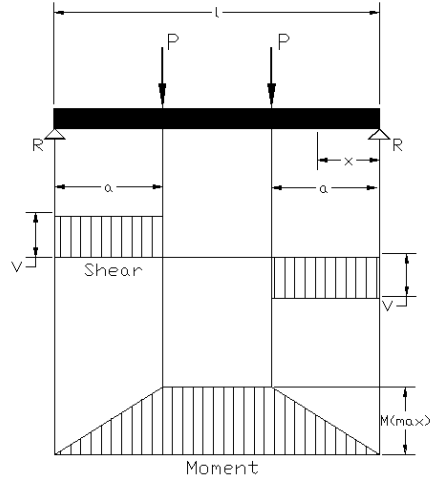

Table 4-2

Shear Areas and Shear Coefficients for Various Cross Sections							
for calculating A' , $A' = kA_w$							
Cross Section	Type	Shear Area	k	Cross Section	Type	Shear Area	k
	Rectangular Section	$A_w = bd$	5/6		Channel Section	$A_w = 2bt$	5/6
	I or W-Section	$A_w = 2bt$	5/6		Channel Section	$A_w = ht$	1
	I or W-Section	$A_w = th$	1		Solid Round	$A = \pi R^2$	8/9
	Square Tube	$A_w = 2th$	1		Angle Section	$A_w = th$	1
	Rectangular Tube	$A_w = 2tb$	5/6		Circular Tube	$A_w = 2\pi Rt$	1/4

Note: \rightarrow Arrows indicate direction of shear forces k = Shear coefficient A_w = Shear area
 Note: Values are approximated for simplicity. For exact shear coefficients reference Timoshenko's Beam Theory.

Examples of Beam Selection of PulTex Profiles used as Flexural Members

Example 1.

Design Parameters

Select a PulTex Wide Flange Section capable of withstanding a uniform load of 90 lbs./ft., over a simply supported span of 17', with a deflection limit of L/180. The beam is laterally supported and has an assumed weight of 4.92 lbs./ft.

Solution

Refer to the Allowable Uniform Load Tables. The load tables do not take into account the weight of the beam; therefore, add the weight of the section to the design load. From the Allowable Uniform Load Tables, reference the 6" x 6" x 3/8" Wide Flange Section. Locate the span column and find the 17' span and look across the columns to the L/180 column. The number in the space represents a uniform load of 95 lbs./ft. This load is more than the design load of 90 lbs./ft + 4.92 lbs./ft (assumed weight of selected beam) = 94.92 lbs./ft. Therefore, the section is adequate. **Select a 6" x 6" x 3/8" Wide Flange Section.**

Example 2.

Design Parameters

Select a PulTex Wide Flange Section that is simply supported and is capable of withstanding a laterally unsupported load of 200 lbs/ft at a span of 21' with a deflection less than L/240.

Solution

Reference the Allowable Uniform Load Tables. Select a member size to begin the process. Locate the 8" x 8" x 3/8" Wide Flange Section and the span of 21'. Locate the Allowable load, laterally unsupported beam, global buckling capacity and locate the 21ft. span and load interface. The maximum load is 87 lbs./ft and is not adequate; therefore, select a larger Wide Flange Section. Select a 10" x 10" x 1/2" Wide Flange Section. Locate the 21' span and Maximum Load Laterally Unsupported column. The maximum load is 261 lbs./ft with a 2x safety factor. The 261 lbs./ft. load is greater than the design load plus the weight of the Wide Flange Section; therefore, the 10" x 10" x 1/2" beam is adequate. Scanning across the columns, notice that the 211 lbs./ft. design load is less than the 229 lbs./ft. load in the L/240 column; therefore, the deflection will be less than L/240.

Select a 10" x 10" x 1/2" Wide Flange Section.

Example 3.

Design Parameters

Determine the maximum allowable point load and deflection of a laterally unsupported 6" x 6" x 3/8" Wide Flange Section that is simply supported at a span of 12'. The beam is to be used in a 10% concentration of Potassium Hydroxide.

Solution

Step 1. Reference equation (P-1) for lateral-torsional buckling.

$$M_{cr} = C_b \frac{\pi}{KL_b} \sqrt{\left(\frac{\pi E_y}{KL_b}\right)^2 C_w I_y + E_y I_y GJ}$$

C_w = Warping constant (in⁶)

J = Torsion constant (in⁴)

C_b = Moment gradient adjuster

M_{cr} = Critical moment (in-lbs.)

L = Unsupported length (in)

E_y = Modulus of elasticity for bending about minor axis (psi) $E_y \approx E$

Example 3. (cont'd)

- G = Shear modulus (psi)
- K = Effective length coefficient (ref. Table 1)

Step 2. Use equation (P-2) to predict the critical moment M_{cr} . Obtain the moment variation constant C_b from Table 1. C_b is 1.35 for the simply supported beam with no end constraints and a point load (Table 4-1.)

L is the laterally unsupported length of 12' or 144".

E is the modulus of elasticity (reference the PulTex Fiber Reinforced Polymer Structural Profiles Material Properties Sheet) $E = 4.0e6$ psi.

G is the modulus of rigidity (Shear Modulus) (reference the PulTex Fiber Reinforced Polymer Structural Profiles Material Properties Sheet) $G = 500,000$ psi

C_w is the warping constant; a value can be located in the Elements of Section in the Design Manual. For the 6" x 6" x 3/8" Wide Flange Section, $C_w = 119.84$ in⁶.

J is torsion constant, a value can be found in the Elements of Section in the Design Manual. For the 6" x 6" x 3/8" Wide Flange Section, $J = 0.316$ in⁴.

I_y is the moment of inertia about the weak axis, $I_y = 13.32$ in⁴. (from Elements of Section)

K is the effective length coefficient from Table 1., $K = 1$.

Step 3. Equate M_{cr}

$$M_{cr} = 1.35 \frac{\pi}{(1)144''} \sqrt{\left(\frac{\pi 4e6 \text{ psi}}{(1)144''}\right)^2 (119.84 \text{ in}^6)(13.32 \text{ in}^4) + (4.0e6 \text{ psi})(13.32 \text{ in}^4)(5e5 \text{ psi})(.316 \text{ in}^4)}$$

$$M_{cr} = 133,593.72 \text{ lbs-in}$$

For a simply supported span with a point load at mid span, the maximum moment is given by $M = PL/4$.

Where:

P = point load in (lbs.)

L = length of span (in), equals L_b in the present case.

Therefore, calculate P .

$$133593.72 \text{ lbs-in} = P(144'')/4$$

$$P = 3,710 \text{ lbs.}$$

Apply the desired safety factor. In this case, use a 2.5 safety factor.

Therefore, $P_{\text{allowable}} = 1,484$ lbs.

Step 4. Calculate the allowable deflection with the 1,484 lb. load.

$$\Delta = \frac{1}{48} \frac{PL^3}{EI} + \frac{1}{4} \frac{PL}{GA'}$$

From the beam deflection equations, determine the equation for the simply supported, mid-span, point load condition.

Where: $A' = kA_w$

Δ = Deflection (in)

P = Concentrated load (lbs.); i.e., $P_{\text{allowable}} = 1,484$ lbs.

L = length of span (in) 144"

G = Modulus of rigidity (Shear modulus) (psi) i.e., 500,000 psi

E = Full section modulus of elasticity (psi), i.e., 4.0e6 psi

I_x = Moment of inertia (in⁴), i.e., 40.76 in⁴

Example 3. (cont'd)

$$A' = kA_w, \text{ i.e. } 1(2.25\text{in}^2)=2.25\text{in}^2$$

$$A_w = \text{Cross sectional area of web (in}^2\text{)}(t)(h)$$

$$k = \text{Shear Coefficient Reference Table 4-2. (Shear area of common cross sections), i.e.,(Table 4-2)}$$

Step 5. Solve for deflection Δ .

$$\Delta = \frac{1}{48} \frac{(1484\text{lbs.})(144\text{'})^3}{(4e6\text{psi})(40.76\text{in}^4)} + \frac{1}{4} \frac{(1484\text{lbs.})(144\text{'})}{(5e5\text{psi})(2.25\text{in}^2)}$$

$$\Delta = 0.614\text{' or L/235}$$

Step 6. Determine if the flexural strength is adequate.

$$\sigma_f = M/S_x$$

Where:

$$\sigma_f = \text{flexural stress (psi)}$$

$$M = \text{maximum moment (lbs.-in)}$$

$$S_x = \text{Section modulus (in}^3\text{)}$$

From the Elements of Section of The New and Improved Design Manual for Pultrusion of Standard and Custom Fiber Reinforced Polymer Structural Profiles, determine S_x for the 6"x6"x3/8" Wide Flange Section. $S_x = 13.59 \text{ in}^3$.

From the PulTex **SuperStructural** Profiles for Wide Flange Sections and I-Sections Material Properties Sheets, determine the ultimate flexural strength and apply the proper safety factor, which in the present case is 2.5.

$$\sigma_f = 33,000 \text{ psi ultimate flexural strength.}$$

$$(33,000 \text{ psi}/2.5) = (P144\text{'}/4)/13.59\text{in}^3$$

$$P_{\text{flexural}} = 4,983 \text{ lbs.}$$

$$P_{\text{flexural}} > P_{\text{allowable}} \text{ therefore, the strength is adequate.}$$

Step 7. Calculate the Critical Buckling load and determine if it is adequate. From equation (P-3):

$$\sigma_x^{cr} = \frac{\pi^2}{12} \left(\frac{t_f}{b} \right)^2 \left[\sqrt{q} \left(2 \sqrt{(E_x)_f (E_y)_f} \right) + p \left((E_y)_f (v_{xy})_f + 2(G_{xy})_f \right) \right]$$

$$p = 0.3 + \left(\frac{0.004}{\zeta - 0.5} \right); q = 0.025 + \left(\frac{0.065}{\zeta + 0.4} \right); \zeta = \frac{2b_w (E_y)_f}{b_f (E_y)_w}; b = \frac{b_f}{2}$$

Where:

$$\sigma_x^{cr} = \text{Critical buckling stress in (psi)}$$

$$b = \text{Half the width of the compression flange for I/W sections (in)}$$

$$b = \text{The width of the compression flange for box sections, } b=b_f \text{ (in)}$$

$$b_f = \text{width of the compression flange (in)}$$

$$b_w = \text{Height of the section (in)}$$

$$E_x = \text{Longitudinal modulus of elasticity (psi)}$$

$$E_y = \text{Transverse modulus of elasticity (psi)}$$

f = Flange
 G_{xy} = Modulus of rigidity (Shear Modulus) (psi)
 p = Constant defined by the coefficient of restraint (ζ)
 q = Constant defined by the coefficient of restraint (ζ)
 t = Thickness of the compression flange (in)
 ζ = Coefficient of restraint of the compression plates
 σ_x^{cr} = 22,647 psi

Step 7. The allowable local buckling load is determined by evaluating the critical buckling stress to bending stress and applying the appropriate safety factor. In this case use 2.5.

Use $\sigma = M/S_x$ where, $M=PL/4$

Therefore, $P = (\sigma_x^{cr} S_x 4)/L$

$$P_{\text{buckling}} = (22,647 \text{ psi} * 13.58 * 4) / 144" = 8,542 \text{ lbs.} / 2.5$$

$P_{\text{allowable}} = 3,417 \text{ lbs.} > P_{\text{global buckling}} 1,484 \text{ lbs.}$; therefore, global buckling governs the design.

The design is governed by M_{cr} Lateral Torsional Buckling (Global buckling) and is limited to 1,484 lbs.

Reference the Chemical Compatibility Guide to determine the proper PulTex Series.

Choose PulTex 1625 Series.

Channel Selection Example

Example 4.

Determine the Channel section that is required to support a uniform load of 70 lbs./ft at a span of 24' with a maximum deflection criteria of $L/D = 180$.

Step 1. Locate the channel uniform load tables in chapter 4. Next, locate the **Simply Supported Beam with Uniform Loads at various L/D ratio** section of the allowable uniform load tables.

Step 2. Locate the column with the 180 heading. This stands for the L/D ratio of 180. Next, refer to the left hand side of the page until you see the Span section. Locate the 24' span section. Find the intersection of the 24' span and the L/D ratio of 180.

Step 3. Page through the channel sections until a number greater than or equal to 70 lbs/ft is obtained. You will conclude that an 11-1/2"x2-3/4"x1/2" channel is required. The actual value is 72 lbs/ft.

Step 4. Scan across the columns and review the allowable uniform loads. The allowable uniform loads will be based on the shear, flexural, local buckling and lateral support spacing. The lowest number between the values at the 24' span will dictate the allowable uniform load according to the strength of the beam. The $L/D=180$ column is based strictly on deflection.

Step 5. Referencing the 24' span tab, once concludes that the lowest value is 271 lbs./ft with lateral restraint and 12 lbs./ft with lateral restraints. As one can conclude, lateral restraint is very important.

Example 4. (cont'd)

Step 6. Determine the number of lateral restraints and the maximum spacing by referencing the **Maximum Lateral Support Spacing** column. One can conclude that the maximum spacing distance is 36". Therefore, in order for the charts to hold true, a minimum of nine restraints with a maximum spacing of 36" is required.

Note: The lateral restraint spacing can be modified, however the loads must be reevaluated based on the lateral restraint spacing. The graphs that depict the ultimate moment capacity versus lateral restraint can be utilized to make the necessary adjustments to the allowable uniform loads.

Example 5.

Determine the lateral spacing of the diaphragms that are necessary for a structure of two 8"x2-3/16"x3/8" channels that are positioned 36" apart and span 20'. The structure is required to hold an ultimate point load of 4,000 lbs. located over the center of the 20' span. The 4,000 lbs. had been factored to include a 2.5 times safety factor.

Step 1. Locate the Ultimate Moment Capacity versus Lateral Restraint graph in the channel uniform load tables. Reference the 8"x2-3/16"x3/8" graph.

Step 2. Determine the moment acting on the two channels. The moment is calculated by $PL/4$ for the simply supported structure with a point load in the middle. The corresponding moment is 20,000 lb.*ft.

Step 3. In referencing the graph and concluding that the two channels will be required to resist a total moment of 20,000 lb.*ft. One concludes that one of the channels must support a moment of 10,000 lb.*ft. Scan across the graph at the 10,000 lb.*ft mark. The lateral buckling curve is intersected at approximately the 48" bracing spacing. Therefore, the channels must be braced at a maximum support spacing of 48". One must note that the values are not factored and that appropriate safety factors must be applied. In this case the factors were applied to the 4,000 lb. point load prior to determining the lateral spacing required.

Step 4. Design the structure with diaphragms spaced at 48" on center. The deflection and shearing, flexural and local compression stresses should always be checked.

Nomenclature

Δ	=	Deflection (in)
Δ	=	$1-(\nu_{xy}\nu_{yx})$
ζ	=	Coefficient of restraint of the compression plates
σ_c	=	Compressive stress (psi)
σ_x^{cr}	=	Critical buckling stress in (psi)
ν_{xy}	=	Poisson's ratio (longitudinal)
ν_{yx}	=	Poisson's ratio (transverse)
a	=	Unsupported length or region over which N_x acts (length of beam) inches
A_w	=	Shear area of profile (Table 2) (in ²)
A'	=	kA_w , Shear coefficient x shear area of profile (in ²)
b	=	Half the width of the compression flange for I/W sections (in)
b	=	The width of the compression flange for box sections, $b=b_f$ (in)
b_f	=	Width of the compression flange (in)
b_w	=	Height of the section (in)
C_b	=	Moment Variation Constant
C_w	=	Warping Constant (in ⁶)
D	=	Deflection (in)
D_{11}, D_{22}	=	Flexural rigidity in 1, 2 and radial directions
E_x or E_y	=	Modulus of elasticity of the major or minor axis (psi)
$E_{y \text{ local}}$	=	Local transverse modulus of Elasticity (psi)
f	=	Flange
f_b	=	Flexural stress (psi)
f_v	=	Shear stress (psi)
G	=	Shear modulus (modulus of rigidity) (psi)
G_{xy}	=	Shear modulus (psi)
h	=	Depth of section (in)
I_x or I_y	=	Moment of Inertia about desired axis (in ⁴)
J	=	Torsion Constant (in ⁴)
K	=	Effective length coefficient
k	=	Shear coefficient (Table 2.)
L	=	Length (inches)
L_b	=	Unsupported length between points that have lateral restraint (in)
M	=	Maximum moment (in-lbs)
M_{cr}	=	Critical Moment that causes lateral buckling (in-lbs)
P	=	Point load (lbs.)
p	=	Constant defined by the coefficient of restraint (ζ)
q	=	Constant defined by the coefficient of restraint (ζ)
r	=	Radius of gyration (in)
S_x	=	Section modulus (in ³)
t	=	Thickness of compression flange (in)
V	=	Shear Force (lbs.)
W_t	=	Weight of profile in lbs./ft
W_{lb}	=	Maximum load governed by critical local buckling (lbs./ft)
W_f	=	Maximum load governed by flexural stress (lbs./ft)
W_v	=	Maximum load governed by shear strength (lbs./ft)
W_{lu}	=	Maximum laterally unsupported load (lbs./ft)
L/D	=	Ratio of length of the span to the deflection

Channel Section Nomenclature

a	=	the length of the plate (panel)
b	=	the width of the plate (panel)
$b_f (= w)$	=	the widths of flange (Figure 1)
$b_w (= h)$	=	the widths of web (Figure 1)
E_x	=	the panel stiffness in x-direction
E_y	=	the panel stiffness in y-direction
G_{xy}	=	the panel in-plane shear stiffness
h	=	the height of the channel (Figure 1)
I_{xx}	=	the moment of inertial of the channel section along the strong axis
I_{yy}	=	the moment of inertial of the channel section along the weak axis
I_{ww}	=	the warping stiffness of the channel section
JG	=	the torsional stiffness of the channel section
L	=	the span length
m	=	the number of buckling half waves
M_{cr}	=	the critical moment of the channel section subject to buckling
$(N_x)_{cr}$	=	the plate local buckling strength
P_{cr}	=	the lateral buckling load through the shear center of channel section
t	=	the thickness the flange
ν_{xy}	=	the panel Poisson's ratio
w	=	the widths of the channel (Figure 1)
ξ	=	the coefficient of restraint for flange-web connection
γ_{cr}	=	the critical aspect ratio
σ_{cr}	=	the critical stress

Introduction to PulTex **SuperStructural** Profiles

Product Advantage Summary

When comparing pultruded fiber reinforced polymer composites to traditional building materials such as steel, one will notice that the strengths of the materials are generally comparable while the stiffness characteristics are dissimilar. For example, the modulus of elasticity of steel is approximately 29E6 psi., while the modulus of elasticity of a typical pultruded Wide Flange Section is 2.5-2.8E6 psi. The stiffness difference is 11.5 times between the two materials. In an effort to improve stiffness, Creative Pultrusions, has modified the fiber architecture of selected structural profiles. The result improved the modulus of elasticity from 2.5-2.8E6 psi to 3.9-4.0E6 psi., an average improvement in E-Modulus of 49%. PulTex **SuperStructural** profiles offer the designer the ability to design longer spans with heavier loads. The most important advantage is a more economical design, as material and labor costs are greatly reduced.

The following example is a comparison of a standard pultruded section to a PulTex **SuperStructural** profile.

Example 1.0

Reference Creative Pultrusions former Design Guide, Volume 5, Revision 8, Allowable Uniform Load Tables, page 3-17. The allowable uniform load of a standard 6" x 6" x 3/8" Wide Flange Section at a span of 10' and L/D ratio of 360 is 149 lbs./ft. Referencing The New and Improved PulTex Pultrusion lbs./ft. The difference is a 48% increase in E-Modulus. The graph below demonstrates the difference between the PulTex **SuperStructural** 6" x 6" x 3/8" Wide Flange Section and a standard pultruded 6" x 6" x 3/8" Wide Flange Section. The graph demonstrates the allowable uniform loads for each beam at various spans with the deflection limit of L/D = 360.

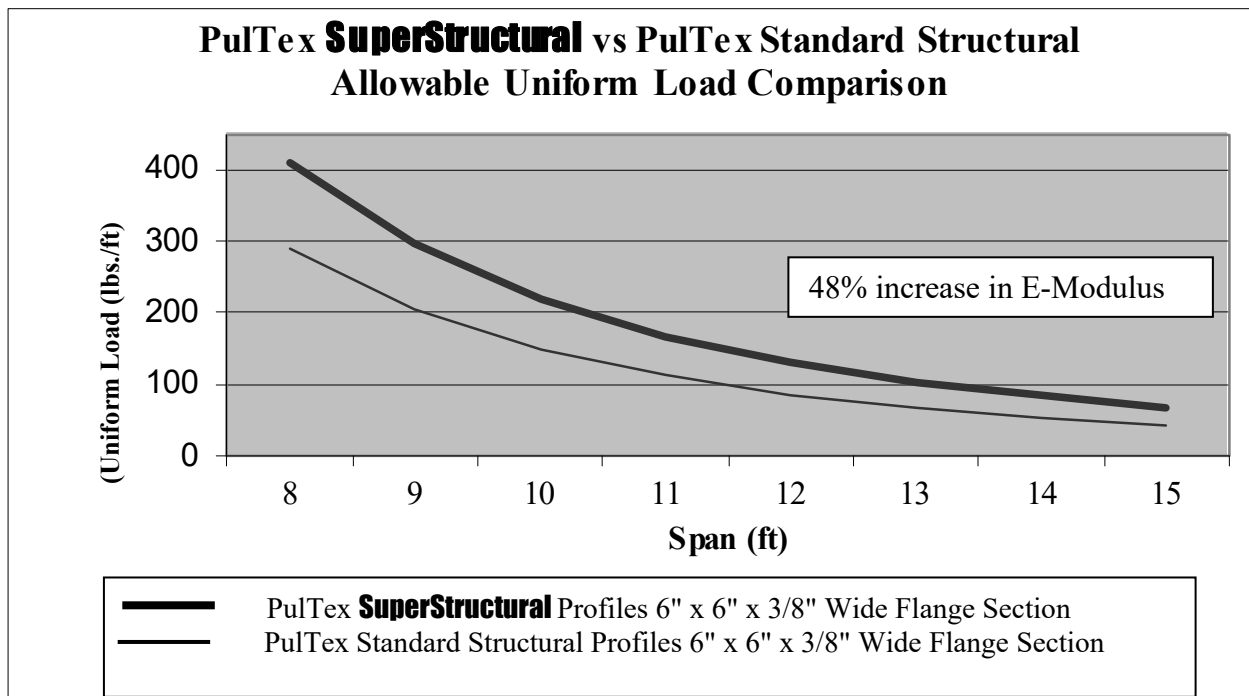

Project example: Plating Tank Cover Design

1. Standard Structural Project Design Factors

Description: Plating tank cover 10' x 60'

Design load: 80 psf

Maximum deflection: L/180 or .67"

Service temperature: 80°F

5% concentration of Chromic Acid

Step 1. Based on the 80 psf + the 3.46 psf DL of Flowgrip[®], determine the allowable beam spacing.

Step 2. Reference Creative Pultrusions former Design Guide, Volume 5, Revision 8.
For a 6"x6"x3/8" Wide Flange Beam, the allowable uniform load at L/180 is 298 lbs/ft.

Step 3. Determine the allowable spacing by dividing the allowable load by the design load, i.e.,
(298 lbs/ft)/83.46lbs/ft²= 3.57' O.C.

Step 4. Space the beams @ 3.5' O.C. (Note: beam weight excluded)

Bill of Materials for Standard Structural Project Design

<u>Item</u>	<u>Quantity</u>	<u>Price \$</u>	<u>Total</u>
6"x6"x3/8" W-Section; 1625; Spaced 3.5' O.C.	19 pcs. @11'	\$24.28/ft	\$5,074.52
Flowgrip [®] Solid Panel	21 pcs. @20'	\$33.14/ft	\$13,918.80
Misc., i.e., fasteners, adhesive			
Total Material Price			<u>\$18,993.32</u>

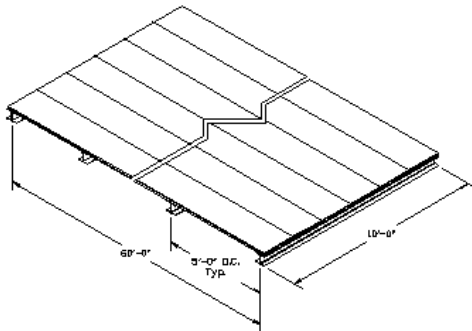

PulTex **SuperStructural** Profiles

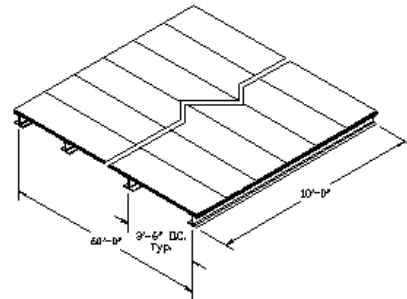

PulTex Standard Structural Profiles

2. PulTex SuperStructural Project Design Factors

Description: Plating tank cover 10' x 60'

Design load: 80 psf

Maximum deflection: L/180 or .67"

Service temperature: 80°F

5% concentration of Chromic Acid

Step 1. Determine the maximum span of Flowgrip[®] Solid Floor Panel.

a. Reference page 7 of the Solutions that Work---The Most Complete Line of Grating and Access Structure Products in the Industry

Note: The Flowgrip[®] Solid Floor Panel will span 60" and satisfy the above design criteria.
(The beam spacing is based on 5' O.C.)

- Step 2. Determine which Wide Flange Section profile will satisfy the loading condition above.
- 80 psf x 5' panel width = 400 lbs/ft live load on the beams.
 - Calculate the dead load. Assume that a 6" x 6" x 3/8" Wide Flange Section profile is sufficient.
 - The weight of the 6" x 6" x 3/8" section is 4.92 lbs/ft.
 - Calculate the weight of the Flowgrip[®] 3.46 psf x 5' = 17.3 lbs/ft.
- Step 3. Determine the total live load (LL) and dead load (DL) combination.
- 400 lbs/ft LL + 4.92 lbs/ft DL + 17.3 lbs/ft DL = 422.2 lbs./ft.
- Step 4. Determine if the 6" x 6" x 3/8" Wide Flange Section profile is adequate.
- Reference the 6" x 6" x 3/8" Wide Flange Section in the Allowable Uniform Load Tables.
 - Locate the 10' span row and look across to the L/180 deflection column.
 - The PulTex **SuperStructural** 6" x 6" x 3/8" Wide Flange Section will hold 441 lbs/ft and deflect less than L/180; therefore, the 6" x 6" x 3/8" Wide Flange Section profile is **adequate**.
- Step 5. Space all beams at 5' O.C. across the 10' section of the span.

Bill of Materials for PulTex **SuperStructural** Project Design

<u>Item</u>	<u>Quantity</u>	<u>Price \$</u>	<u>Total</u>
6"x6"x3/8" W-Section; 1625; Spaced 5' O.C.	13 pcs. @11'	\$24.28/ft	\$3,472.04
Flowgrip [™] Solid Floor Panel	21 pcs. @ 20'	\$33.14/ft	\$13,918.80
Misc., i.e., fasteners, adhesives			
Total Material Price			<u>\$17,390.84</u>

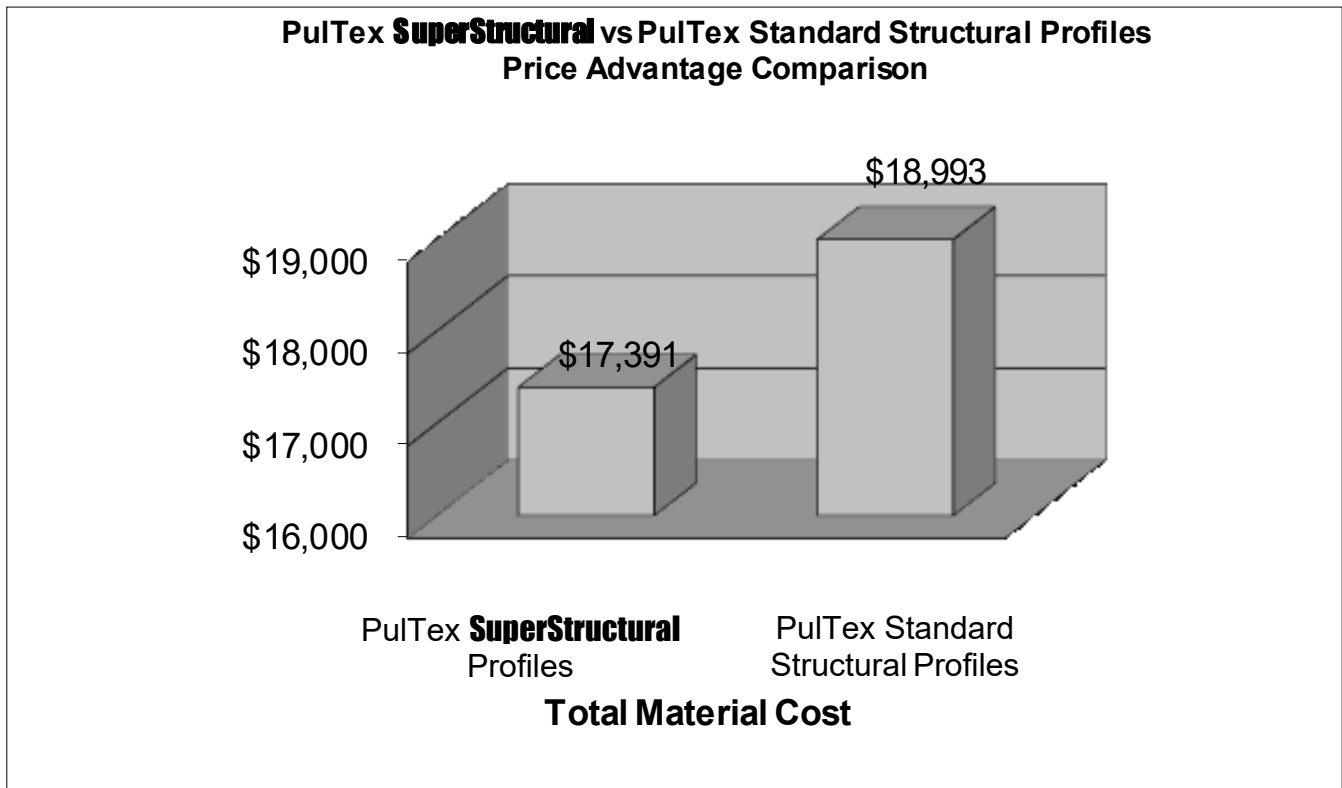

Span/Deflection Ratio Conversion Tables

Span	Span	L/D=80	L/D=100	L/D=150	L/D=180	L/D=240	L/D=360	L/D=500
feet	Inches	Deflection (in)						
1.0	12	0.15	0.12	0.08	0.07	0.05	0.03	0.02
1.5	18	0.23	0.18	0.12	0.10	0.08	0.05	0.04
2.0	24	0.30	0.24	0.16	0.13	0.10	0.07	0.05
2.5	30	0.38	0.30	0.20	0.17	0.13	0.08	0.06
3.0	36	0.45	0.36	0.24	0.20	0.15	0.10	0.07
3.5	42	0.53	0.42	0.28	0.23	0.18	0.12	0.08
4.0	48	0.60	0.48	0.32	0.27	0.20	0.13	0.10
4.5	54	0.68	0.54	0.36	0.30	0.23	0.15	0.11
5.0	60	0.75	0.60	0.40	0.33	0.25	0.17	0.12
5.5	66	0.83	0.66	0.44	0.37	0.28	0.18	0.13
6.0	72	0.90	0.72	0.48	0.40	0.30	0.20	0.14
6.5	78	0.98	0.78	0.52	0.43	0.33	0.22	0.16
7.0	84	1.05	0.84	0.56	0.47	0.35	0.23	0.17
7.5	90	1.13	0.90	0.60	0.50	0.38	0.25	0.18
8.0	96	1.20	0.96	0.64	0.53	0.40	0.27	0.19
8.5	102	1.28	1.02	0.68	0.57	0.43	0.28	0.20
9.0	108	1.35	1.08	0.72	0.60	0.45	0.30	0.22
9.5	114	1.43	1.14	0.76	0.63	0.48	0.32	0.23
10.0	120	1.50	1.20	0.80	0.67	0.50	0.33	0.24
10.5	126	1.58	1.26	0.84	0.70	0.53	0.35	0.25
11.0	132	1.65	1.32	0.88	0.73	0.55	0.37	0.26
11.5	138	1.73	1.38	0.92	0.77	0.58	0.38	0.28
12.0	144	1.80	1.44	0.96	0.80	0.60	0.40	0.29
12.5	150	1.88	1.50	1.00	0.83	0.63	0.42	0.30
13.0	156	1.95	1.56	1.04	0.87	0.65	0.43	0.31
13.5	162	2.03	1.62	1.08	0.90	0.68	0.45	0.32
14.0	168	2.10	1.68	1.12	0.93	0.70	0.47	0.34
14.5	174	2.18	1.74	1.16	0.97	0.73	0.48	0.35
15.0	180	2.25	1.80	1.20	1.00	0.75	0.50	0.36
15.5	186	2.33	1.86	1.24	1.03	0.78	0.52	0.37
16.0	192	2.40	1.92	1.28	1.07	0.80	0.53	0.38
16.5	198	2.48	1.98	1.32	1.10	0.83	0.55	0.40
17.0	204	2.55	2.04	1.36	1.13	0.85	0.57	0.41
17.5	210	2.63	2.10	1.40	1.17	0.88	0.58	0.42
18.0	216	2.70	2.16	1.44	1.20	0.90	0.60	0.43
18.5	222	2.78	2.22	1.48	1.23	0.93	0.62	0.44
19.0	228	2.85	2.28	1.52	1.27	0.95	0.63	0.46
19.5	234	2.93	2.34	1.56	1.30	0.98	0.65	0.47

Span/Deflection Ratio Conversion Tables - Cont'd

Span	Span	L/D=80	L/D=100	L/D=150	L/D=180	L/D=240	L/D=360	L/D=500
feet	Inches	Deflection (in)						
20.0	240	3.00	2.40	1.60	1.33	1.00	0.67	0.48
20.5	246	3.08	2.46	1.64	1.37	1.03	0.68	0.49
21.0	252	3.15	2.52	1.68	1.40	1.05	0.70	0.50
21.5	258	3.23	2.58	1.72	1.43	1.08	0.72	0.52
22.0	264	3.30	2.64	1.76	1.47	1.10	0.73	0.53
22.5	270	3.38	2.70	1.80	1.50	1.13	0.75	0.54
23.0	276	3.45	2.76	1.84	1.53	1.15	0.77	0.55
23.5	282	3.53	2.82	1.88	1.57	1.18	0.78	0.56
24.0	288	3.60	2.88	1.92	1.60	1.20	0.80	0.58
24.5	294	3.68	2.94	1.96	1.63	1.23	0.82	0.59
25.0	300	3.75	3.00	2.00	1.67	1.25	0.83	0.60
25.5	306	3.83	3.06	2.04	1.70	1.28	0.85	0.61
26.0	312	3.90	3.12	2.08	1.73	1.30	0.87	0.62
26.5	318	3.98	3.18	2.12	1.77	1.33	0.88	0.64
27.0	324	4.05	3.24	2.16	1.80	1.35	0.90	0.65
27.5	330	4.13	3.30	2.20	1.83	1.38	0.92	0.66
28.0	336	4.20	3.36	2.24	1.87	1.40	0.93	0.67
28.5	342	4.28	3.42	2.28	1.90	1.43	0.95	0.68
29.0	348	4.35	3.48	2.32	1.93	1.45	0.97	0.70
29.5	354	4.43	3.54	2.36	1.97	1.48	0.98	0.71
30.0	360	4.50	3.60	2.40	2.00	1.50	1.00	0.72
30.5	366	4.58	3.66	2.44	2.03	1.53	1.02	0.73
31.0	372	4.65	3.72	2.48	2.07	1.55	1.03	0.74
31.5	378	4.73	3.78	2.52	2.10	1.58	1.05	0.76
32.0	384	4.80	3.84	2.56	2.13	1.60	1.07	0.77
32.5	390	4.88	3.90	2.60	2.17	1.63	1.08	0.78
33.0	396	4.95	3.96	2.64	2.20	1.65	1.10	0.79
33.5	402	5.03	4.02	2.68	2.23	1.68	1.12	0.80
34.0	408	5.10	4.08	2.72	2.27	1.70	1.13	0.82
34.5	414	5.18	4.14	2.76	2.30	1.73	1.15	0.83
35.0	420	5.25	4.20	2.80	2.33	1.75	1.17	0.84
35.5	426	5.33	4.26	2.84	2.37	1.78	1.18	0.85
36.0	432	5.40	4.32	2.88	2.40	1.80	1.20	0.86
36.5	438	5.48	4.38	2.92	2.43	1.83	1.22	0.88
37.0	444	5.55	4.44	2.96	2.47	1.85	1.23	0.89
37.5	450	5.63	4.50	3.00	2.50	1.88	1.25	0.90
38.0	456	5.70	4.56	3.04	2.53	1.90	1.27	0.91
38.5	462	5.78	4.62	3.08	2.57	1.93	1.28	0.92
39.0	468	5.85	4.68	3.12	2.60	1.95	1.30	0.94
39.5	474	5.93	4.74	3.16	2.63	1.98	1.32	0.95
40.0	480	6.00	4.80	3.20	2.67	2.00	1.33	0.96

Allowable Uniform Load Tables

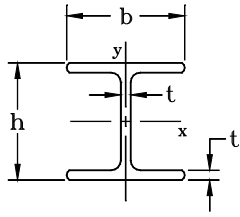

PulTex **SuperStructural** Profiles Wide Flange Sections

3" x 3" x 1/4" (Part# IW 340) 1500/1525/1625 Series		Ultimate In-Plane Shear Strength (psi)	7,000	Simply Supported beam with Uniform Loads at various L/D ratios					
		Ultimate Flexural Strength (psi)	33,000	(lbs/ft)					
E = 4.0x10 ⁶ psi G = 5.0x10 ⁵ psi		Ultimate Local Buckling Strength (psi)	40,261	Maximum L _b = 2 ft.					
I _x = 3.23 in ⁴ S _x = 2.15 in ³		Simply Supported with a Uniform Load			L/D ratio				
A _w = .75 in ² Wt. = 1.85 lbs/ft		Laterally Supported beams							
Span (feet)	Allowable load, laterally unsupported beam global buckling capacity, 2.5x Safety Factor (lbs/ft)	Allowable load, local compression buckling capacity, 2.5x Safety Factor (lbs/ft)	Allowable load, flexural capacity, 2.5x Safety Factor (lbs/ft)	Allowable load, In-plane shear of the web capacity, 3x Safety Factor (lbs/ft)	100	150	180	240	360
2	9156	5771	4730	1750					1520
3	1941	2565	2102	1167			1130	847	565
4	668	1443	1183	875		628	523	392	262
5	300	923	757	700	505	337	280	210	140
6	159	641	526	583	300	200	167	125	83
7	94	471	386	500	192	128	107	80	53
8	60	361	296	438	130	87	72	54	36

Note: Bold numbers in the Factored Load Tables represent the governing load

4" x 4" x 1/4" (Part # IW 440) 1500/1525/1625 Series		Ultimate In-Plane Shear Strength (psi)	7,000	Simply Supported beam with Uniform Loads at various L/D ratios					
		Ultimate Flexural Strength (psi)	33,000	(lbs/ft)					
E = 4.0x10 ⁶ psi G = 5.0x10 ⁵ psi		Ultimate Local Buckling Strength (psi)	22,647	Maximum L _b = 2.5 ft.					
I _x = 8.05 in ⁴ S _x = 4.03 in ³		Simply Supported with a Uniform Load			L/D ratio				
A _w = 1.00 in ² Wt. = 2.86 lbs/ft		Laterally Supported beams							
Span (feet)	Allowable load, laterally unsupported beam global buckling capacity, 2.5x Safety Factor (lbs/ft)	Allowable load, local compression buckling capacity, 2.5x Safety Factor (lbs/ft)	Allowable load, flexural capacity, 2.5x Safety Factor (lbs/ft)	Allowable load, In-plane shear of the web capacity, 3x Safety Factor (lbs/ft)	100	150	180	240	360
3	5622	2704	3940	1556					1196
4	1840	1521	2217	1167				882	588
5	784	974	1419	933		782	651	489	326
6	396	676	985	778		474	395	296	197
7	224	497	724	667	460	307	256	192	128
8	138	380	554	583	314	210	175	131	87
9	91	300	438	519	224	149	124	93	62
10	63	243	355	467	165	110	91	69	46
11	45	201	293	424	125	83	69	52	35

Note: Bold numbers in the Factored Load Tables represent the governing load

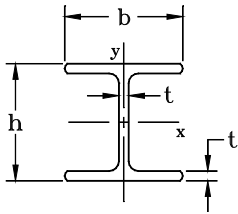

PulTex SuperStructural Profiles
Wide Flange Sections

6" x 6" x 1/4" (Part # IW 640) 1500/1525/1625 Series		Ultimate In-Plane Shear Strength (psi) 7,000			Simply Supported beam with Uniform Loads at various L/D ratios (lbs/ft) Maximum $L_b = 3.5$ ft.				
E = 4.0×10^6 psi G = 5.0×10^5 psi		Ultimate Flexural Strength (psi) 33,000							
I _x = 28.58 in ⁴ S _x = 9.53 in ³		Ultimate Local Buckling Strength (psi) 10,065			L/D ratio				
A _w = 1.50 in ² W _t = 3.83 lbs/ft		Simply Supported with a Uniform Load							
		Laterally Supported beams							
Span (feet)	Allowable load, laterally unsupported beam global buckling capacity, 2.5x Safety Factor (lbs/ft)	Allowable load, local compression buckling capacity, 2.5x Safety Factor (lbs/ft)	Allowable load, flexural capacity, 2.5x Safety Factor (lbs/ft)	Allowable load, In-plane shear of the web capacity, 3x Safety Factor (lbs/ft)	100	150	180	240	360
5	3627	1023	3355	1400					963
6	1768	711	2330	1167					611
7	967	522	1712	1000					409
8	575	400	1310	875					285
9	365	316	1035	778				310	206
10	243	256	839	700				231	154
11	169	211	693	636				176	117
12	122	178	582	583				137	92
13	90	151	496	538			145	109	73
14	68	131	428	500			117	88	59
15	53	114	373	467			96	72	48
16	42	100	328	438		95	80	60	40
17	34	89	290	412		80	67	50	33

Note: Bold numbers in the Factored Load Tables represent the governing load

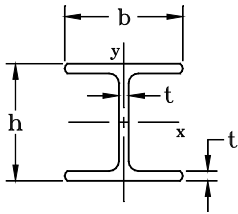

PulTex SuperStructural Profiles
Wide Flange Sections

6" x 6" x 3/8" (Part # IW 660) 1500/1525/1625 Series		Ultimate In-Plane Shear Strength (psi) 7,000 Ultimate Flexural Strength (psi) 33,000 Ultimate Local Buckling Strength (psi) 22,647			Simply Supported beam with Uniform Loads at various L/D ratios (lbs/ft) Maximum $L_b = 3.5$ ft.				
E =4.0x10 ⁶ psi G =5.0x10 ⁵ psi		Simply Supported with a Uniform Load			L/D ratio				
I _x =40.76 in ⁴ S _x =13.59 in ³		Laterally Supported beams							
A _w =2.25 in ² Wt.=5.79 lbs/ft									
Span (feet)	Allowable load, laterally unsupported beam global buckling capacity, 2.5x Safety Factor (lbs/ft)	Allowable load, local compression buckling capacity, 2.5x Safety Factor (lbs/ft)	Allowable load, flexural capacity, 2.5x Safety Factor (lbs/ft)	Allowable load, In-plane shear of the web capacity, 3x Safety Factor (lbs/ft)	100	150	180	240	360
6	2758	2280	3322	1750				1322	882
7	1528	1675	2441	1500		1412	1176	882	588
8	922	1282	1869	1313		984	820	615	410
9	593	1013	1476	1167		710	592	444	296
10	402	821	1196	1050	793	529	441	330	220
11	284	678	988	955	605	403	336	252	168
12	207	570	831	875	472	314	262	196	131
13	156	486	708	808	374	250	208	156	104
14	120	419	610	750	302	201	168	126	84
15	94	365	532	700	247	165	137	103	69
16	75	321	467	656	205	136	114	85	57
17	61	284	414	618	171	114	95	71	48
18	50	253	369	583	145	97	80	60	40
19	42	227	331	553	123	82	69	51	34

Note: Bold numbers in the Factored Load Tables represent the governing load

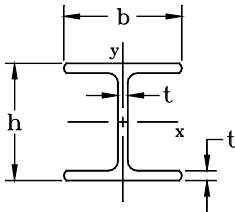

PulTex **SuperStructural** Profiles
Wide Flange Sections

8" x 8" x 3/8" (Part # IW 860) 1500/1525/1625 Series		Ultimate In-Plane Shear Strength (psi)	7,000	Simply Supported beam with Uniform Loads at various L/D ratios (lbs/ft) Maximum L _b = 5 ft.						
E = 4.0x10 ⁶ psi G = 5.0x10 ⁵ psi		Ultimate Flexural Strength (psi)	33,000	L/D ratio						
I _x = 100.35 in ⁴ S _x = 25.09 in ³		Ultimate Local Buckling Strength (psi)	12,739							
A _w = 3.00 in ² Wt. = 7.77 lbs/ft		Simply Supported with a Uniform Load								
		Laterally Supported beams								
Span (feet)	Allowable load, laterally unsupported beam global buckling capacity, 2.5x Safety Factor (lbs/ft)	Allowable load, local compression buckling capacity, 2.5x Safety Factor (lbs/ft)	Allowable load, flexural capacity, 2.5x Safety Factor (lbs/ft)	Allowable load, In-plane shear of the web capacity, 3x Safety Factor (lbs/ft)						
					100	150	180	240	360	
6	8288	2368	6133	2333					1841	
7	4515	1739	4506	2000					1271	
8	2675	1332	3450	1750					908	
9	1689	1052	2726	1556				1003	668	
10	1123	852	2208	1400				757	505	
11	777	704	1825	1273				584	389	
12	557	592	1533	1167				459	306	
13	411	504	1306	1077			490	367	245	
14	310	435	1126	1000			397	298	199	
15	239	379	981	933			327	245	163	
16	188	333	862	875		326	271	204	136	
17	150	295	764	824		274	228	171	114	
18	122	263	681	778		232	193	145	97	
19	100	236	612	737		198	165	124	83	
20	83	213	552	700		171	142	107	71	
21	69	193	501	667		148	123	93	62	
22	59	176	456	636		129	108	81	54	
23	50	161	417	609		113	95	71	47	
24	43	148	383	583		100	83	63	42	
25	37	136	353	560		89	74	56	37	

Note: Bold numbers in the Factored Load Tables represent the governing load

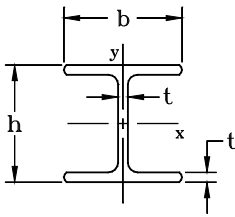

PulTex SuperStructural Profiles
Wide Flange Sections

8" x 8" x 1/2" (Part # IW 880) 1500/1525/1625 Series		Ultimate In-Plane Shear Strength (psi)	7,000	Simply Supported beam with Uniform Loads at various L/D ratios (lbs/ft)					
E =3.9x10 ⁶ psi G =5.0x10 ⁵ psi		Ultimate Flexural Strength (psi)	33,000	Maximum L _b = 5 ft.					
I _x =128.81 in ⁴ S _x =32.20 in ³		Ultimate Local Buckling Strength (psi)	22,443						
A _w =4.00 in ² Wt.=10.39 lbs/ft		Simply Supported with a Uniform Load							
		Laterally Supported beams							
Span (feet)	Allowable load, laterally unsupported beam global buckling capacity, 2.5x Safety Factor (lbs/ft)	Allowable load, local compression buckling capacity, 2.5x Safety Factor (lbs/ft)	Allowable load, flexural capacity, 2.5x Safety Factor (lbs/ft)	Allowable load, In-plane shear of the web capacity, 3x Safety Factor (lbs/ft)	100	150	180	240	360
6	10974	5353	7871	3111					2352
7	6020	3933	5783	2667				2426	1617
8	3593	3011	4428	2333				1728	1152
9	2288	2379	3498	2074		2030	1692	1269	846
10	1533	1927	2834	1867		1530	1275	956	637
11	1071	1593	2342	1697		1179	982	737	491
12	774	1338	1968	1556		926	772	579	386
13	576	1140	1677	1436	1110	740	616	462	308
14	439	983	1446	1333	900	600	500	375	250
15	341	857	1259	1244	739	493	410	308	205
16	271	753	1107	1167	614	409	341	256	171
17	218	667	980	1098	515	344	286	215	143
18	178	595	875	1037	437	291	243	182	121
19	147	534	785	982	373	249	207	156	104
20	123	482	708	933	321	214	179	134	89
21	104	437	643	889	279	186	155	116	77
22	89	398	585	848	243	162	135	101	68
23	76	364	536	812	213	142	119	89	59
24	66	335	492	778	188	126	105	78	52
25	57	308	453	747	167	111	93	70	46
26	50	285	419	718	149	99	83	62	41
27	44	264	389	691	133	89	74	55	37
28	39	246	361	667	119	80	66	50	33
29	35	229	337	644	108	72	60	45	30

Note: Bold numbers in the Factored Load Tables represent the governing load

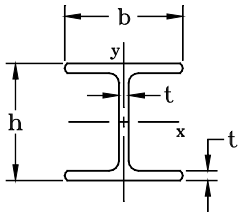

PulTex SuperStructural Profiles
Wide Flange Sections

10" x 10" x 3/8" (Part # IW 960) 1500/1525/1625 Series		Ultimate In-Plane Shear Strength (psi)	7,000	Simply Supported beam with Uniform Loads at various L/D ratios					
		Ultimate Flexural Strength (psi)	33,000	(lbs/ft)					
E = 4.0x10 ⁶ psi G = 5.0x10 ⁵ psi		Ultimate Local Buckling Strength (psi)	8,153	Maximum L _b = 6 ft.					
I _x = 200.45 in ⁴ S _x = 40.09 in ³		Simply Supported with a Uniform Load			L/D ratio				
A _w = 3.75 in ² Wt. = 9.59 lbs/ft		Laterally Supported beams							
Span (feet)	Allowable load, laterally unsupported beam global buckling capacity, 2.5x Safety Factor (lbs/ft)	Allowable load, local compression buckling capacity, 2.5x Safety Factor (lbs/ft)	Allowable load, flexural capacity, 2.5x Safety Factor (lbs/ft)	Allowable load, In-plane shear of the web capacity, 3x Safety Factor (lbs/ft)	100	150	180	240	360
12	1288	605	2450	1458					574
13	942	516	2088	1346					463
14	705	445	1800	1250					378
15	540	387	1568	1167					312
16	420	340	1378	1094					261
17	333	302	1221	1029					220
18	267	269	1089	972					187
19	217	241	977	921				241	161
20	179	218	882	875				208	139
21	148	198	800	833				181	120
22	125	180	729	795				158	105
23	105	165	667	761				139	93
24	90	151	612	729				123	82
25	77	139	564	700				109	73
26	67	129	522	673				97	65
27	58	120	484	648			116	87	58
28	51	111	450	625			104	78	52
29	45	104	419	603			94	71	47
30	39	97	392	583			85	64	43

Note: Bold numbers in the Factored Load Tables represent the governing load

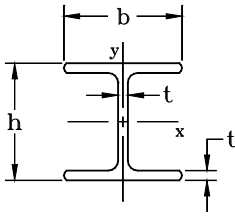

PulTex SuperStructural Profiles
Wide Flange Sections

10" x 10" x 1/2" (Part # IW 980) 1500/1525/1625 Series		Ultimate In-Plane Shear Strength (psi) 7,000 Ultimate Flexural Strength (psi) 33,000 Ultimate Local Buckling Strength (psi) 14,364			Simply Supported beam with Uniform Loads at various L/D ratios (lbs/ft) Maximum $L_b = 6$ ft.				
E = 3.9×10^6 psi G = 5.0×10^5 psi I _x = 259.36 in ⁴ S _x = 51.87 in ³ A _w = 5.0 in ² Wt. = 12.92 lbs/ft		Simply Supported with a Uniform Load			L/D ratio				
Span (feet)	Allowable load, laterally unsupported beam global buckling capacity, 2.5x Safety Factor (lbs/ft)	Allowable load, local compression buckling capacity, 2.5x Safety Factor (lbs/ft)	Allowable load, flexural capacity, 2.5x Safety Factor (lbs/ft)	Allowable load, In-plane shear of the web capacity, 3x Safety Factor (lbs/ft)	L/D ratio				
					100	150	180	240	360
10	3501	1987	4565	2333				1770	1180
11	2417	1642	3772	2121				1381	921
12	1726	1380	3170	1944				1096	730
13	1268	1176	2701	1795				882	588
14	955	1014	2329	1667			960	720	480
15	734	883	2029	1556			793	595	396
16	575	776	1783	1458			662	496	331
17	458	687	1579	1373		670	558	418	279
18	370	613	1409	1296		569	474	356	237
19	302	550	1264	1228		488	407	305	203
20	250	497	1141	1167		421	351	263	175
21	209	451	1035	1111		366	305	229	152
22	176	410	943	1061		320	267	200	133
23	150	376	863	1014		281	234	176	117
24	129	345	792	972		249	207	155	104
25	111	318	730	933		221	184	138	92
26	97	294	675	897		197	164	123	82
27	84	273	626	864		176	147	110	73
28	74	253	582	833	238	158	132	99	66
29	66	236	543	805	214	143	119	89	60
30	58	221	507	778	194	129	108	81	54
31	52	207	475	753	176	117	98	73	49
32	47	194	446	729	160	107	89	67	45
33	42	182	419	707	146	98	81	61	41
34	38	172	395	686	134	89	75	56	37

Note: Bold numbers in the Factored Load Tables represent the governing load

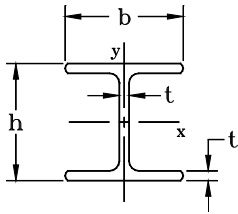

PulTex SuperStructural Profiles
Wide Flange Sections

12" x 12" x 1/2" (Part # IW 982) 1500/1525/1625 Series		Ultimate In-Plane Shear Strength (psi) 7,000			Simply Supported beam with Uniform Loads at various L/D ratios (lbs/ft) Maximum $L_b = 7$ ft.				
E = 3.9×10^6 psi G = 5.0×10^5 psi		Ultimate Flexural Strength (psi) 33,000							
I _x = 457.26 in ⁴ S _x = 76.21 in ³		Ultimate Local Buckling Strength (psi) 9,975			L/D ratio				
A _w = 6.0 in ² Wt. = 15.65 lbs/ft		Simply Supported with a Uniform Load							
		Laterally Supported beams							
Span (feet)	Allowable load, laterally unsupported beam global buckling capacity, 2.5x Safety Factor (lbs/ft)	Allowable load, local compression buckling capacity, 2.5x Safety Factor (lbs/ft)	Allowable load, flexural capacity, 2.5x Safety Factor (lbs/ft)	Allowable load, In-plane shear of the web capacity, 3x Safety Factor (lbs/ft)					
					100	150	180	240	360
10	7077	2027	6706	2800					1362
11	4860	1675	5543	2545					1077
12	3452	1408	4657	2333					863
13	2522	1199	3968	2154					701
14	1887	1034	3422	2000					577
15	1442	901	2981	1867					479
16	1123	792	2620	1750					402
17	888	701	2321	1647					340
18	712	626	2070	1556				605	291
19	579	562	1858	1474				521	250
20	475	507	1677	1400				451	216
21	395	460	1521	1333				393	188
22	331	419	1386	1273				344	165
23	280	383	1268	1217				303	145
24	238	352	1164	1167				268	129
25	204	324	1073	1120			318	239	114
26	176	300	992	1077			284	213	102
27	153	278	920	1037			255	191	92
28	134	259	855	1000			229	172	82
29	118	241	797	966			207	155	74
30	104	225	745	933			187	141	67
31	92	211	698	903		204	170	128	61
32	82	198	655	875		186	155	116	56
33	73	186	616	848		170	142	106	51
34	66	175	580	824		156	130	97	47
35	59	165	547	800		143	119	90	43
36	54	156	517	778		132	110	82	40
37	49	148	490	757		122	101	76	36
38	44	140	464	737		112	94	70	34
39	40	133	441	718		104	87	65	31
40	37	127	419	700		97	81	60	29

Note: Bold numbers in the Factored Load Tables represent the governing load

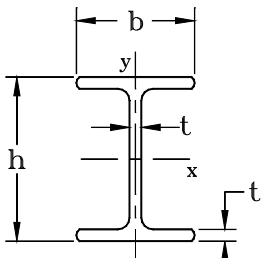

PulTex SuperStructural Profiles
I-Sections

3" x 1-1/2" x 1/4" (Part # IB 340) 1500/1525/1625 Series		Ultimate In-Plane Shear Strength (psi)	7,000	Simply Supported beam with Uniform Loads at various L/D ratios (lbs/ft) Maximum L _b = 1 ft.					
E = 4.0x10 ⁶ psi G = 5.0x10 ⁵ psi		Ultimate Flexural Strength (psi)	33,000	L/D ratio					
I _x = 1.8 in ⁴ S _x = 1.2 in ³		Ultimate Local Buckling Strength (psi)	146,307						
A _w = .75 in ² Wt. = 1.22 lbs/ft		Simply Supported with a Uniform Load							
		Laterally Supported beams							
Span (feet)	Allowable load, laterally unsupported beam global buckling capacity, 2.5x Safety Factor (lbs/ft)	Allowable load, local compression buckling capacity, 2.5x Safety Factor (lbs/ft)	Allowable load, flexural capacity, 2.5x Safety Factor (lbs/ft)	Allowable load, In-plane shear of the web capacity, 3x Safety Factor (lbs/ft)	100	150	180	240	360
2	1415	11705	2640	1750				1515	1010
3	345	5202	1173	1167		830	692	519	346
4	133	2926	660	875	556	370	309	231	154
5	65	1873	422	700	292	195	162	122	81
6	37	1301	293	583	172	114	95	72	48
7	23	955	216	500	109	73	61	45	30

Note: Bold numbers in the Factored Load Tables represent the governing load

4" x 2" x 1/4" (Part # IB 440) 1500/1525/1625 Series		Ultimate In-Plane Shear Strength (psi)	7,000	Simply Supported beam with Uniform Loads at various L/D ratios (lbs/ft) Maximum L _b = 1.25 ft.					
E = 4.0x10 ⁶ psi G = 5.0x10 ⁵ psi		Ultimate Flexural Strength (psi)	33,000	L/D ratio					
I _x = 4.53 in ⁴ S _x = 2.27 in ³		Ultimate Local Buckling Strength (psi)	82,298						
A _w = 1.0 in ² Wt. = 1.65 lbs/ft		Simply Supported with a Uniform Load							
		Laterally Supported beams							
Span (feet)	Allowable load, laterally unsupported beam global buckling capacity, 2.5x Safety Factor (lbs/ft)	Allowable load, local compression buckling capacity, 2.5x Safety Factor (lbs/ft)	Allowable load, flexural capacity, 2.5x Safety Factor (lbs/ft)	Allowable load, In-plane shear of the web capacity, 3x Safety Factor (lbs/ft)	100	150	180	240	360
3	831	5535	2220	1556				1176	784
4	296	3114	1249	1167		875	729	547	364
5	137	1993	799	933	705	470	392	294	196
6	74	1384	555	778	419	280	233	175	116
7	45	1017	408	667	269	179	149	112	75
8	29	778	312	583	182	121	101	76	51
9	20	615	247	519	129	86	72	54	36

Note: Bold numbers in the Factored Load Tables represent the governing load

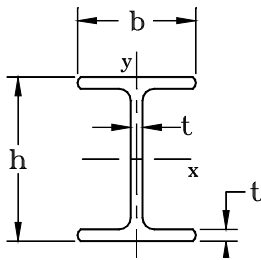

PulTex SuperStructural Profiles
I-Sections

6" x 3" x 1/4" (Part # IB 640) 1500/1525/1625 Series		Ultimate In-Plane Shear Strength (psi)	7,000	Simply Supported beam with Uniform Loads at various L/D ratios					
E = 4.0x10 ⁶ psi G = 5.0x10 ⁵ psi		Ultimate Flexural Strength (psi)	33,000	(lbs/ft) Maximum L _b = 1.75 ft.					
I _x = 16.17 in ⁴ S _x = 5.39 in ³		Ultimate Local Buckling Strength (psi)	36,577						
A _w = 1.5 in ² Wt. = 2.49 lbs/ft		Simply Supported with a Uniform Load			L/D ratio				
Span (feet)	Allowable load, laterally unsupported beam global buckling capacity, 2.5x Safety Factor (lbs/ft)	Allowable load, local compression buckling capacity, 2.5x Safety Factor (lbs/ft)	Allowable load, flexural capacity, 2.5x Safety Factor (lbs/ft)	Allowable load, In-plane shear of the web capacity, 3x Safety Factor (lbs/ft)					
					100	150	180	240	360
4	1169	3286	2965	1750			2203	1652	1101
5	499	2103	1897	1400		1496	1246	935	623
6	252	1460	1318	1167		918	765	574	383
7	143	1073	968	1000	900	600	500	375	250
8	88	821	741	875	618	412	343	258	172
9	58	649	586	778	442	295	245	184	123
10	40	526	474	700	326	217	181	136	91
11	29	434	392	636	247	165	137	103	69
12	22	365	329	583	192	128	107	80	53
13	17	311	281	538	152	101	84	63	42
14	13	268	242	500	122	81	68	51	34

Note: Bold numbers in the Factored Load Tables represent the governing load

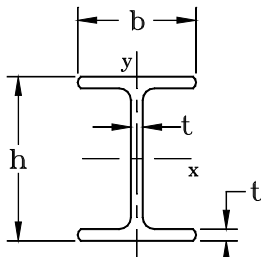

PulTex SuperStructural Profiles
I-Sections

6" x 3" x 3/8" (Part # IB 660) 1500/1525/1625 Series		Ultimate In-Plane Shear Strength (psi)	7,000	Simply Supported beam with Uniform Loads at various L/D ratios (lbs/ft)					
E = 4.0x10 ⁶ psi G = 5.0x10 ⁵ psi		Ultimate Flexural Strength (psi)	33,000	Maximum L _b = 1.75 ft.					
I _x = 22.93 in ⁴ S _x = 7.64 in ³		Ultimate Local Buckling Strength (psi)	82,298						
A _w = 2.25 in ² Wt. = 3.67 lbs/ft		Simply Supported with a Uniform Load			L/D ratio				
Span (feet)	Allowable load, laterally unsupported beam global buckling capacity, 2.5x Safety Factor (lbs/ft)	Allowable load, local compression buckling capacity, 2.5x Safety Factor (lbs/ft)	Allowable load, flexural capacity, 2.5x Safety Factor (lbs/ft)	Allowable load, In-plane shear of the web capacity, 3x Safety Factor (lbs/ft)					
					100	150	180	240	360
4	1918	10479	4202	2625				2377	1585
5	848	6707	2689	2100			1786	1339	893
6	442	4657	1868	1750		1312	1093	820	547
7	259	3422	1372	1500	1284	856	713	535	357
8	164	2620	1051	1313	881	587	489	367	245
9	111	2070	830	1167	629	419	349	262	175
10	78	1677	672	1050	464	309	258	193	129
11	57	1386	556	955	352	234	195	147	98
12	43	1164	467	875	273	182	152	114	76
13	33	992	398	808	216	144	120	90	60
14	26	855	343	750	173	116	96	72	48
15	21	745	299	700	142	94	79	59	39
16	17	655	263	656	117	78	65	49	32

Note: Bold numbers in the Factored Load Tables represent the governing load

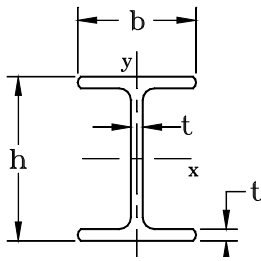

PulTex SuperStructural Profiles
I-Sections

8" x 4" x 3/8" (Part # IB 860) 1500/1525/1625 Series		Ultimate In-Plane Shear Strength (psi)	7,000	Simply Supported beam with Uniform Loads at various L/D ratios (lbs/ft) Maximum $L_b = 2.5$ ft.					
$E = 4.0 \times 10^6$ psi $G = 5.0 \times 10^5$ psi		Ultimate Flexural Strength (psi)	33,000	L/D ratio					
$I_x = 56.71$ in ⁴ $S_x = 14.18$ in ³		Ultimate Local Buckling Strength (psi)	46,292						
$A_w = 3.0$ in ² Wt. = 5.17 lbs/ft		Simply Supported with a Uniform Load							
		Laterally Supported beams							
Span (feet)	Allowable load, laterally unsupported beam global buckling capacity, 2.5x Safety Factor (lbs/ft)	Allowable load, local compression buckling capacity, 2.5x Safety Factor (lbs/ft)	Allowable load, flexural capacity, 2.5x Safety Factor (lbs/ft)	Allowable load, In-plane shear of the web capacity, 3x Safety Factor (lbs/ft)	100	150	180	240	360
6	1144	4862	3466	2333				1823	1215
7	642	3572	2547	2000		1950	1625	1219	813
8	393	2735	1950	1750		1361	1134	851	567
9	256	2161	1541	1556	1476	984	820	615	410
10	176	1750	1248	1400	1099	733	611	458	305
11	125	1447	1031	1273	839	559	466	350	233
12	93	1216	867	1167	654	436	364	273	182
13	70	1036	738	1077	520	346	289	217	144
14	55	893	637	1000	419	280	233	175	116
15	43	778	555	933	343	229	191	143	95
16	35	684	487	875	284	189	158	118	79
17	29	606	432	824	238	159	132	99	66
18	24	540	385	778	201	134	112	84	56
19	20	485	346	737	172	114	95	71	48
20	17	438	312	700	148	98	82	61	41
21	14	397	283	667	128	85	71	53	35
22	12	362	258	636	111	74	62	46	31

Note: Bold numbers in the Factored Load Tables represent the governing load

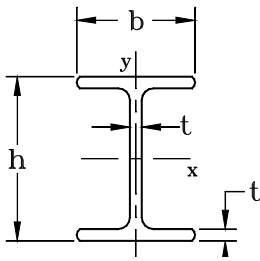

PulTex SuperStructural Profiles
I-Sections

8" x 4" x 1/2" (Part # IB 880) 1500/1525/1625 Series		Ultimate In-Plane Shear Strength (psi)	7,000	Simply Supported beam with Uniform Loads at various L/D ratios (lbs/ft)					
E = 3.9x10 ⁶ psi G = 5.0x10 ⁵ psi		Ultimate Flexural Strength (psi)	33,000	Maximum L _b = 2.5 ft.					
I _x = 72.48 in ⁴ S _x = 18.12 in ³		Ultimate Local Buckling Strength (psi)	81,587						
A _w = 4.0 in ² Wt. = 6.81 lbs/ft		Simply Supported with a Uniform Load			L/D ratio				
Span (feet)	Allowable load, laterally unsupported beam global buckling capacity, 2.5x Safety Factor (lbs/ft)	Allowable load, local compression buckling capacity, 2.5x Safety Factor (lbs/ft)	Allowable load, flexural capacity, 2.5x Safety Factor (lbs/ft)	Allowable load, In-plane shear of the web capacity, 3x Safety Factor (lbs/ft)	L/D ratio				
					100	150	180	240	360
6	1622	10951	4429	3111			3073	2305	1537
7	929	8045	3254	2667		2458	2048	1536	1024
8	578	6160	2492	2333		1711	1426	1069	713
9	384	4867	1969	2074	1853	1235	1029	772	515
10	267	3942	1595	1867	1378	919	765	574	383
11	194	3258	1318	1697	1051	701	584	438	292
12	145	2738	1107	1556	819	546	455	341	227
13	111	2333	944	1436	650	433	361	271	181
14	87	2011	814	1333	524	349	291	218	146
15	70	1752	709	1244	429	286	238	179	119
16	57	1540	623	1167	355	237	197	148	99
17	47	1364	552	1098	297	198	165	124	83
18	39	1217	492	1037	251	167	140	105	70
19	33	1092	442	982	214	143	119	89	60
20	28	986	399	933	184	123	102	77	51
21	24	894	362	889	159	106	89	66	44
22	21	815	329	848	139	93	77	58	39
23	18	745	301	812	122	81	68	51	34
24	16	684	277	778	107	72	60	45	30

Note: Bold numbers in the Factored Load Tables represent the governing load

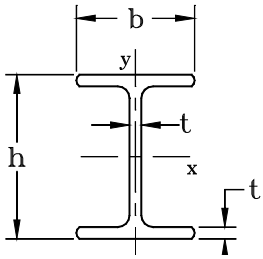

PulTex SuperStructural Profiles
I-Sections

10" x 5" x 3/8" (Part # IB 960) 1500/1525/1625 Series		Ultimate In-Plane Shear Strength (psi)	7,000	Simply Supported beam with Uniform Loads at various L/D ratios (lbs/ft)					
E = 4.0x10 ⁶ psi G = 5.0x10 ⁵ psi		Ultimate Flexural Strength (psi)	33,000	Maximum L _b = 3 ft.					
I _x = 113.55 in ⁴ S _x = 22.71 in ³		Ultimate Local Buckling Strength (psi)	29,627						
A _w = 3.75 in ² Wt. = 6.43 lbs/ft		Simply Supported with a Uniform Load			L/D ratio				
		Laterally Supported beams							
Span (feet)	Allowable load, laterally unsupported beam global buckling capacity, 2.5x Safety Factor (lbs/ft)	Allowable load, local compression buckling capacity, 2.5x Safety Factor (lbs/ft)	Allowable load, flexural capacity, 2.5x Safety Factor (lbs/ft)	Allowable load, In-plane shear of the web capacity, 3x Safety Factor (lbs/ft)	100	150	180	240	360
8	856	2803	3123	2188			2099	1574	1049
9	547	2215	2467	1944		1847	1539	1154	770
10	368	1794	1998	1750		1390	1159	869	579
11	258	1483	1652	1591		1070	892	669	446
12	187	1246	1388	1458		840	700	525	350
13	139	1062	1183	1346	1006	671	559	419	280
14	107	915	1020	1250	816	544	453	340	227
15	83	797	888	1167	670	446	372	279	186
16	66	701	781	1094	556	371	309	232	155
17	53	621	692	1029	467	311	259	195	130
18	44	554	617	972	396	264	220	165	110
19	36	497	554	921	338	225	188	141	94
20	30	449	500	875	291	194	162	121	81
21	26	407	453	833	252	168	140	105	70
22	22	371	413	795	220	147	122	92	61
23	19	339	378	761	193	129	107	80	54
24	16	311	347	729	170	114	95	71	47
25	14	287	320	700	151	101	84	63	42
26	13	265	296	673	135	90	75	56	37
27	11	246	274	648	120	80	67	50	33
28	10	229	255	625	108	72	60	45	30

Note: Bold numbers in the Factored Load Tables represent the governing load

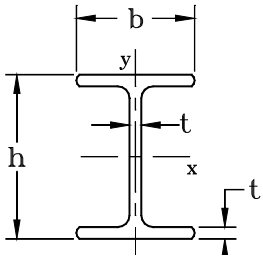

PulTex SuperStructural Profiles
I-Sections

10" x 5" x 1/2" (Part # IB 980) 1500/1525/1625 Series		Ultimate In-Plane Shear Strength (psi)	7,000	Simply Supported beam with Uniform Loads at various L/D ratios					
E = 3.9x10 ⁶ psi G = 5.0x10 ⁵ psi		Ultimate Flexural Strength (psi)	33,000	(lbs/ft)					
I _x = 146.45 in ⁴ S _x = 29.29 in ³		Ultimate Local Buckling Strength (psi)	52,215						
A _w = 5.0 in ² Wt. = 8.51 lbs/ft		Simply Supported with a Uniform Load			Maximum L _b = 3.5 ft.				
		Laterally Supported beams							
Span (feet)	Allowable load, laterally unsupported beam global buckling capacity, 2.5x Safety Factor (lbs/ft)	Allowable load, local compression buckling capacity, 2.5x Safety Factor (lbs/ft)	Allowable load, flexural capacity, 2.5x Safety Factor (lbs/ft)	Allowable load, In-plane shear of the web capacity, 3x Safety Factor (lbs/ft)	100	150	180	240	360
8	1190	6372	4027	2917			2670	2002	1335
9	770	5035	3182	2593		2345	1954	1465	977
10	524	4078	2578	2333		1762	1469	1101	734
11	372	3371	2130	2121	2033	1355	1129	847	565
12	273	2832	1790	1944	1594	1063	886	664	443
13	206	2413	1525	1795	1272	848	707	530	353
14	159	2081	1315	1667	1030	687	572	429	286
15	126	1813	1146	1556	845	564	470	352	235
16	101	1593	1007	1458	702	468	390	292	195
17	82	1411	892	1373	589	393	327	245	164
18	68	1259	796	1296	499	333	277	208	139
19	57	1130	714	1228	426	284	237	178	118
20	48	1020	644	1167	367	245	204	153	102
21	41	925	584	1111	318	212	177	132	88
22	35	843	533	1061	277	185	154	116	77
23	30	771	487	1014	243	162	135	101	68
24	26	708	447	972	215	143	119	89	60
25	23	653	412	933	190	127	106	79	53
26	20	603	381	897	169	113	94	71	47
27	18	559	354	864	152	101	84	63	42
28	16	520	329	833	136	91	76	57	38
29	14	485	306	805	123	82	68	51	34
30	13	453	286	778	111	74	62	46	31

Note: Bold numbers in the Factored Load Tables represent the governing load

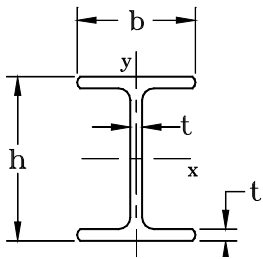

PulTex SuperStructural Profiles
I-Sections

12" x 6" x 1/2" (Part # IB 982) 1500/1525/1625 Series		Ultimate In-Plane Shear Strength (psi) 7,000 Ultimate Flexural Strength (psi) 33,000 Ultimate Local Buckling Strength (psi) 36,261			Simply Supported beam with Uniform Loads at various L/D ratios (lbs/ft) Maximum $L_b = 3.5$ ft.				
E= 3.9×10^6 psi G = 5.0×10^5 psi I _x = 258.76in ⁴ S _x =43.13 in ³ A _w = 6.0 in ² Wt.= 10.31 lbs/ft		Simply Supported with a Uniform Load			L/D ratio				
Span (feet)	Allowable load, laterally unsupported beam global buckling capacity, 2.5x Safety Factor (lbs/ft)	Allowable load, local compression buckling capacity, 2.5x S.F. (lbs/ft)	Allowable load, flexural capacity, 2.5x Safety Factor (lbs/ft)	Allowable load, In-plane shear of the web capacity, 3x Safety Factor (lbs/ft)					
					100	150	180	240	360
10	976	4170	3795	2800			2442	1832	1221
11	682	3447	3137	2545		2274	1895	1421	948
12	493	2896	2636	2333		1797	1497	1123	749
13	367	2468	2246	2154		1442	1202	901	601
14	280	2128	1936	2000	1760	1173	978	733	489
15	218	1854	1687	1867	1450	967	806	604	403
16	173	1629	1483	1750	1208	805	671	503	336
17	140	1443	1313	1647	1017	678	565	424	282
18	114	1287	1171	1556	863	575	480	360	240
19	94	1155	1051	1474	739	493	410	308	205
20	79	1043	949	1400	637	425	354	265	177
21	67	946	861	1333	553	369	307	230	154
22	57	862	784	1273	483	322	268	201	134
23	49	788	717	1217	424	283	236	177	118
24	42	724	659	1167	375	250	208	156	104
25	37	667	607	1120	333	222	185	139	92
26	32	617	561	1077	296	198	165	123	82
27	29	572	521	1037	265	177	147	111	74
28	25	532	484	1000	238	159	132	99	66
29	23	496	451	966	215	143	119	90	60
30	20	463	422	933	194	130	108	81	54
31	18	434	395	903	177	118	98	74	49
32	16	407	371	875	161	107	89	67	45
33	15	383	349	848	147	98	82	61	41
34	13	361	328	824	134	90	75	56	37
35	12	340	310	800	123	82	68	51	34

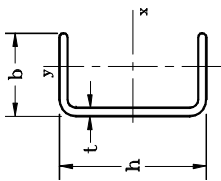

**PuTex Standard Structural Profiles
Channels**

3" x 7/8" x 1/4" (Part # CH 340) 1500/1525/1625 Series		Ultimate In-Plane Shear Stress (psi) Ultimate Flexural Stress (psi)		Simply Supported Beam with a Uniform Load		Load Tables Based on Minimum Lateral Support L/D ratio					
Span (feet)	Number of lateral restraints per total span (Including Ends)	Maximum lateral support spacing (inches)	Load Tables Based on Laterally Supported Beams Unless Noted			Simply Supported beam with Uniform Loads at various L/D ratios (lbs/ft)					
			Allowable load without lateral support 2.5x safety factor (lbs/ft)	Allowable local compression buckling capacity of flange, 2.5x safety factor (lbs/ft)	Allowable load based on the beam flexural capacity, 2.5x safety factor (lbs/ft)	Allowable load, In-plane shear parallel to the web, capacity, 3x safety factor (lbs/ft)	100	150	180	240	360
2	4	10	428	2429	1493	1307	****	1083	903	677	451
2.5	4	10	218	1555	956	1045	878	585	488	366	244
3	5	10	126	1080	664	871	524	349	291	218	145
3.5	6	10	79	793	488	747	336	224	187	140	93
4	6	10	53	607	373	653	228	152	127	95	63
4.5	7	10	37	480	295	581	161	108	90	67	45
5	7	10	27	389	239	523	118	79	66	49	33
5.5	8	10	20	321	197	475	89	60	50	37	25
6	9	10	16	270	166	436	69	46	38	29	19
6.5	9	10	12	230	141	402	54	36	30	23	15
7	10	10	10	198	122	373	44	29	24	18	12
7.5	10	10	8	173	106	348	36	24	20	15	10
8	11	10	7	152	93	327	29	20	16	12	8
8.5	12	10	6	134	83	307	25	16	14	10	7
9	12	10	5	120	74	290	21	14	11	9	6
9.5	13	10	4	108	66	275	18	12	10	7	5
10	13	10	3	97	60	261	15	10	8	6	4

Note: Bold numbers in the Factored Load Tables represent the governing load Reduction for weight of profile has not been applied to the charts

**Ultimate Moment Capacity V.S. Lateral Restraint
Pultex® CH340 3" x 7/8" x 1/4"**

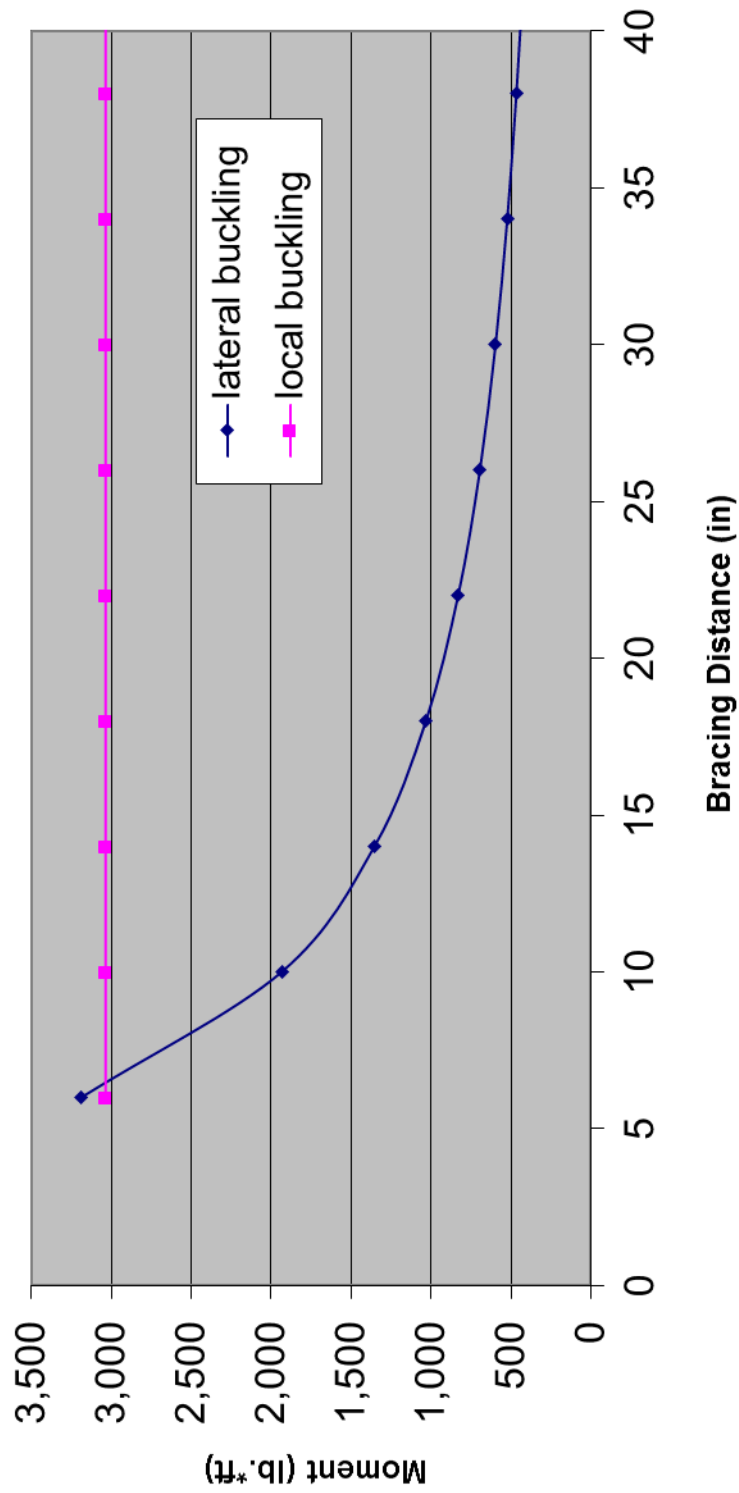

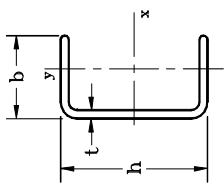

PulTex Standard Structural Profiles Channels

3" x 1-1/2" x 1/4" (Part # CH 342) 1500/1525/1625 Series $E_y = 2.8 \times 10^6$ psi $I_x = 1.61$ in ⁴ $A_w = .75$ in ² $E_y = 1.0 \times 10^6$ psi $G = 5.0 \times 10^5$ psi $S_x = 1.07$ in ³ Wt. = 1.04 lbs/ft		Ultimate In-Plane Shear Stress (psi) Ultimate Flexural Stress (psi) Ultimate Local Flange Buckling Stress (psi) Ultimate Lateral-torsional Buckling Stress with Maximum Lateral Support bracing (psi)			Simply Supported Beams with a Uniform Load		Simply Supported beam with Uniform Loads at various L/D ratios (lbs/ft)				
		Load Tables Based on Laterally Supported Beams Unless Noted			Load Tables Based on Minimum Lateral Support L/D ratio						
Span (feet)	Number of lateral restraints per total span (Including Ends)	Maximum lateral support spacing (inches)	Load Tables Based on Laterally Supported Beams Unless Noted		Simply Supported Beams with a Uniform Load						
			Allowable load without lateral support 2.5x safety factor (lbs/ft)	Allowable local compression buckling capacity of flange, 2.5x safety factor (lbs/ft)	Allowable load based on the beam flexural capacity, 2.5x safety factor (lbs/ft)	Allowable load, In-plane shear parallel to the web, capacity, 3x safety factor (lbs/ft)	100	150	180	240	360
2	2	28	1091	1846	2354	1750	****	1669	1391	1043	695
2.5	3	28	556	1181	1507	1400	1364	909	758	568	379
3	3	28	321	820	1046	1167	818	545	454	341	227
3.5	3	28	202	603	769	1000	526	351	292	219	146
4	3	28	135	461	589	875	358	238	199	149	99
4.5	3	28	95	365	465	778	254	169	141	106	70
5	4	28	69	295	377	700	186	124	104	78	52
5.5	4	28	52	244	311	636	141	94	78	59	39
6	4	28	40	205	262	583	109	73	60	45	30
6.5	4	28	31	175	223	538	86	57	48	36	24
7	4	28	25	151	192	500	69	46	38	29	19
7.5	5	28	20	131	167	467	56	37	31	23	16
8	5	28	17	115	147	438	46	31	26	19	13
8.5	5	28	14	102	130	412	39	26	22	16	11
9	5	28	12	91	116	389	33	22	18	14	9
9.5	6	28	10	82	104	368	28	19	15	12	8
10	6	28	9	74	94	350	24	16	13	10	7

Note: Bold numbers in the Factored Load Tables represent the governing load Reduction for weight of profile has not been applied to the charts

**Ultimate Moment capacity v.s. Lateral restraint
Pultex® CH342 3"x1 1/2"x1/4" Channel**

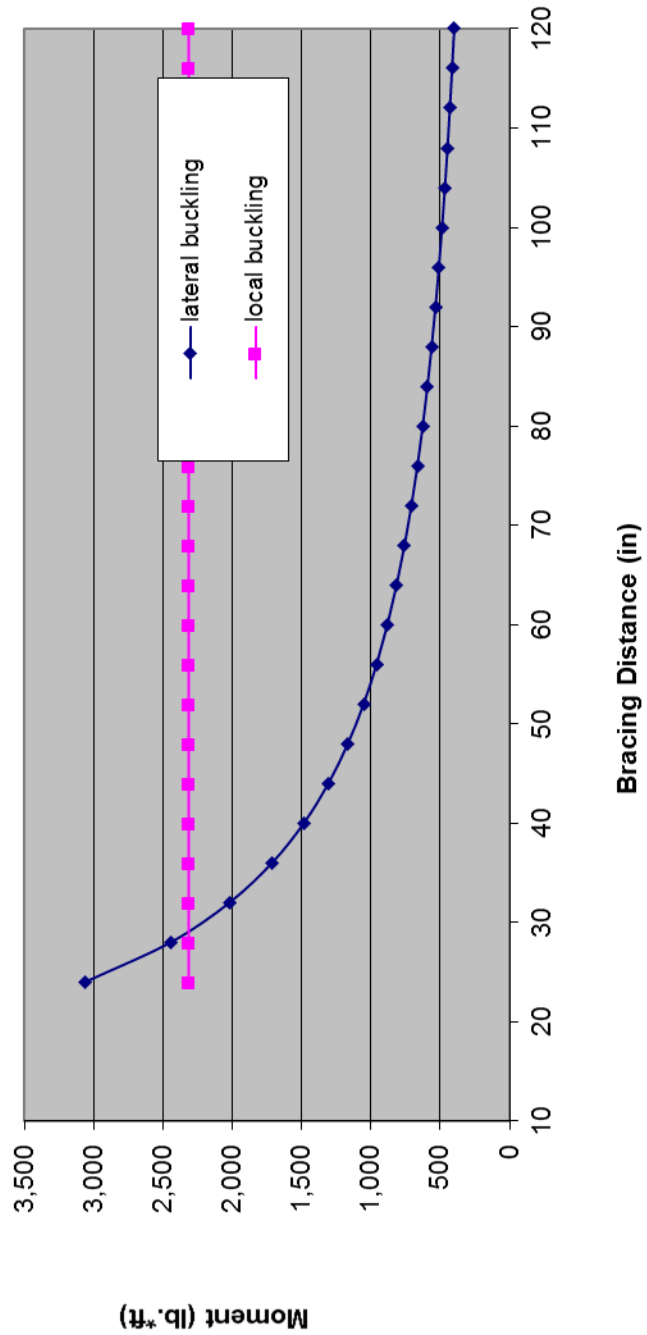

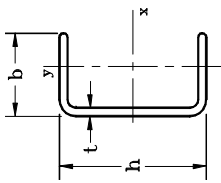

**PulTex Standard Structural Profiles
Channels**

4" x 1-1/8" x 1/4" (Part # CH 440) 1500/1525/1625 Series		Ultimate In-Plane Shear Stress (psi) Ultimate Flexural Stress (psi)		Simply Supported Beam with a Uniform Load		Simply Supported Beam with Uniform Loads at various L/D ratios (lbs/ft)						
E _y = 2.8x10 ⁶ psi I _x = 2.62 in ⁴ A _w = 1.0 in ²		E _y = 1.0x10 ⁶ psi G = 5.0x10 ⁵ psi S _x = 1.31 in ³ W _t = 1.07 lbs/ft		Ultimate Local Flange Buckling Stress (psi) Ultimate Lateral-torsional Buckling Stress with Maximum Lateral Support bracing (psi)		7,000 33,000 34,820 36,181		Load Tables Based on Minimum Lateral Support L/D ratio				
Span (feet)	Number of lateral restraints per total span (Including Ends)	Maximum lateral support spacing (inches)	Load Tables Based on Laterally Supported Beams Unless Noted			100	150	180	240	360		
			Allowable load, local compression buckling capacity of flange, 2.5x safety factor (lbs/ft)	Allowable load based on the beam flexural capacity, 2.5x safety factor (lbs/ft)	Allowable load, In-plane shear parallel to the web, capacity, 3x safety factor (lbs/ft)							
2	3	15	758	3041	2882	2333	2620	2183	1637	1092		
2.5	3	15	386	1946	1844	1867	1443	1203	902	601		
3	4	15	222	1352	1281	1556	871	726	545	363		
3.5	4	15	140	993	941	1333	563	469	352	235		
4	5	15	94	760	721	1167	384	320	240	160		
4.5	5	15	66	601	569	1037	273	228	171	114		
5	5	15	48	487	461	933	201	167	126	84		
5.5	6	15	36	402	381	848	152	127	95	63		
6	6	15	28	338	320	778	118	98	73	49		
6.5	7	15	22	288	273	718	93	77	58	39		
7	7	15	17	248	235	667	75	62	47	31		
7.5	7	15	14	216	205	622	61	51	38	25		
8	8	15	12	190	180	583	50	42	31	21		
8.5	8	15	10	168	160	549	42	35	26	17		
9	9	15	8	150	142	519	35	29	22	15		
9.5	9	15	7	135	128	491	30	25	19	13		
10	9	15	6	122	115	467	26	22	16	11		

**Note: Bold numbers in the Factored Load Tables represent the governing load
Reduction for weight of profile has not been applied to the charts**

Ultimate Moment Capacity V.S. Lateral Restraint
Pultex® CH440 4"x1 1/8"x1/4"

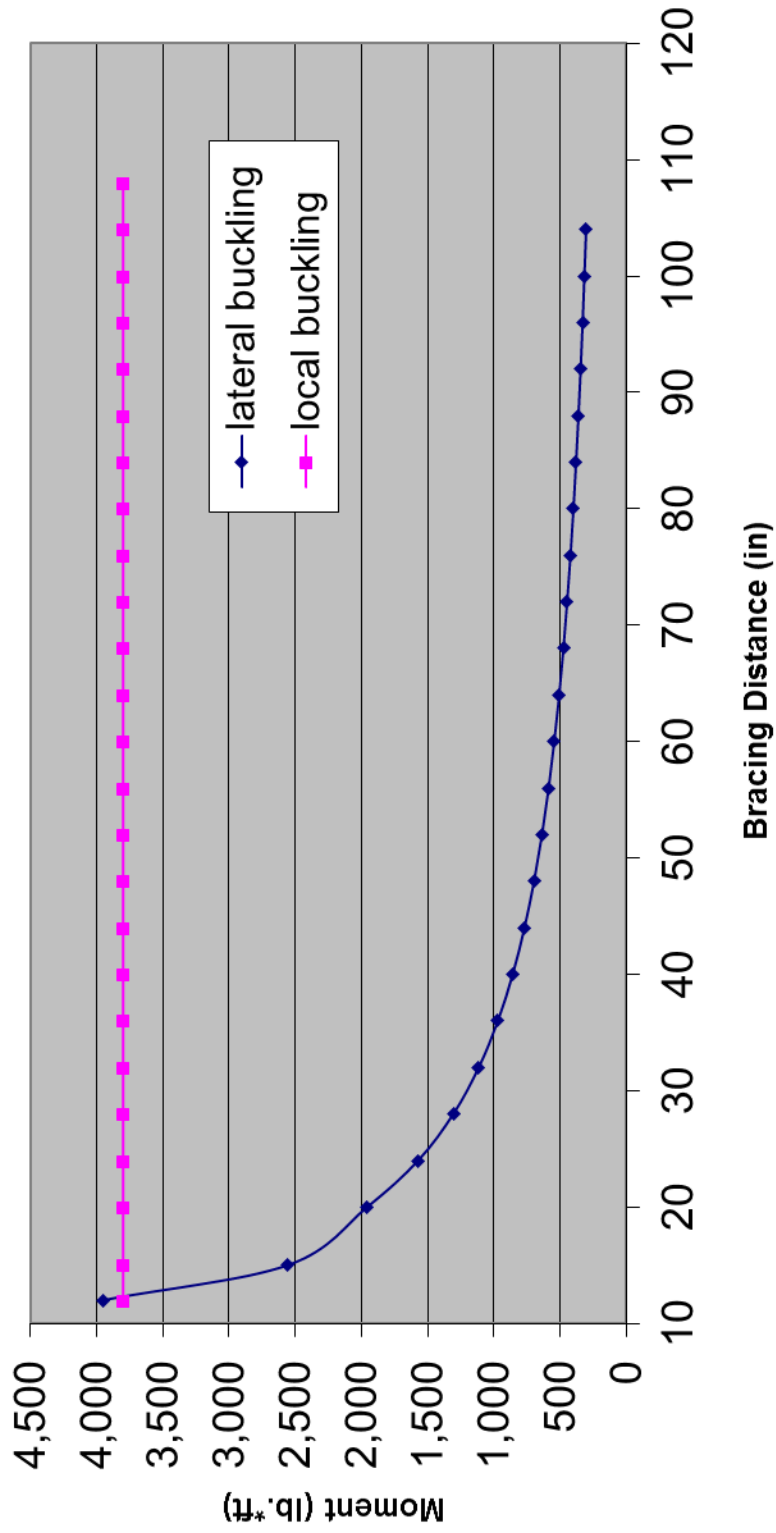

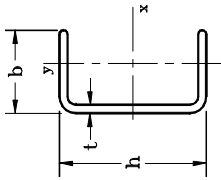

**PulTex Standard Structural Profiles
Channels**

4-1/2" x 2-1/2" x 1/4" (Part # CH 450)		Ultimate In-Plane Shear Stress (psi)		Simply Supported Beam with a Uniform Load		Simply Supported Beam with Uniform Loads at various L/D ratios (lbs/ft)								
1500/1525/1625 Series		Ultimate Flexural Stress (psi)		Load Tables Based on Laterally Supported Beams Unless Noted					Load Tables Based on Minimum Lateral Support L/D ratio					
Span (feet)	Number of lateral restraints per total span (Including Ends)	Maximum lateral support spacing (inches)	Load Tables Based on Laterally Supported Beams Unless Noted		Simply Supported Beam with a Uniform Load									
			Allowable load, local compression buckling capacity of flange, 2.5x safety factor (lbs/ft)	Allowable load based on the beam flexural capacity, 2.5x safety factor (lbs/ft)	Allowable load without lateral support 2.5x safety factor (lbs/ft)	Allowable load, local compression buckling capacity of flange, 2.5x safety factor (lbs/ft)	Allowable load based on the beam flexural capacity, 2.5x safety factor (lbs/ft)	Allowable load, In-plane shear parallel to the web, capacity, 3x safety factor (lbs/ft)	100	150	180	240	360	
2	2	77	1949	6516	3129	5094	*****	*****	*****	*****	*****	*****	*****	*****
2.5	2	77	1247	4170	1590	4075	*****	*****	*****	*****	*****	*****	*****	*****
3	2	77	866	2896	916	3396	*****	*****	*****	*****	*****	*****	*****	*****
3.5	2	77	636	2128	575	2911	*****	*****	*****	*****	*****	*****	*****	590
4	2	77	487	1629	385	2547	*****	*****	*****	*****	*****	*****	*****	403
4.5	2	77	385	1287	270	2264	*****	*****	*****	*****	*****	*****	*****	287
5	2	77	312	1043	197	2037	*****	*****	*****	*****	*****	*****	*****	212
5.5	2	77	258	862	148	1852	*****	*****	*****	*****	*****	*****	*****	160
6	2	77	217	724	114	1698	*****	*****	*****	*****	*****	*****	*****	124
6.5	3	77	184	617	89	1567	*****	*****	*****	*****	*****	*****	*****	98
7	3	77	159	532	72	1455	*****	*****	*****	*****	*****	*****	*****	79
7.5	3	77	139	463	58	1358	*****	*****	*****	*****	*****	*****	*****	64
8	3	77	122	407	48	1273	*****	*****	*****	*****	*****	*****	*****	53
8.5	3	77	108	361	40	1199	*****	*****	*****	*****	*****	*****	*****	44
9	3	77	96	322	34	1132	*****	*****	*****	*****	*****	*****	*****	37
9.5	3	77	86	289	29	1072	*****	*****	*****	*****	*****	*****	*****	32
10	3	77	78	261	25	1019	*****	*****	*****	*****	*****	*****	*****	27

Note: Bold numbers in the Factored Load Tables represent the governing load Reduction for weight of profile has not been applied to the charts

**Moment Capacity V.S. Lateral Restraint
Pultex CH450 4 1/2" X2 1/2" X1/4"**

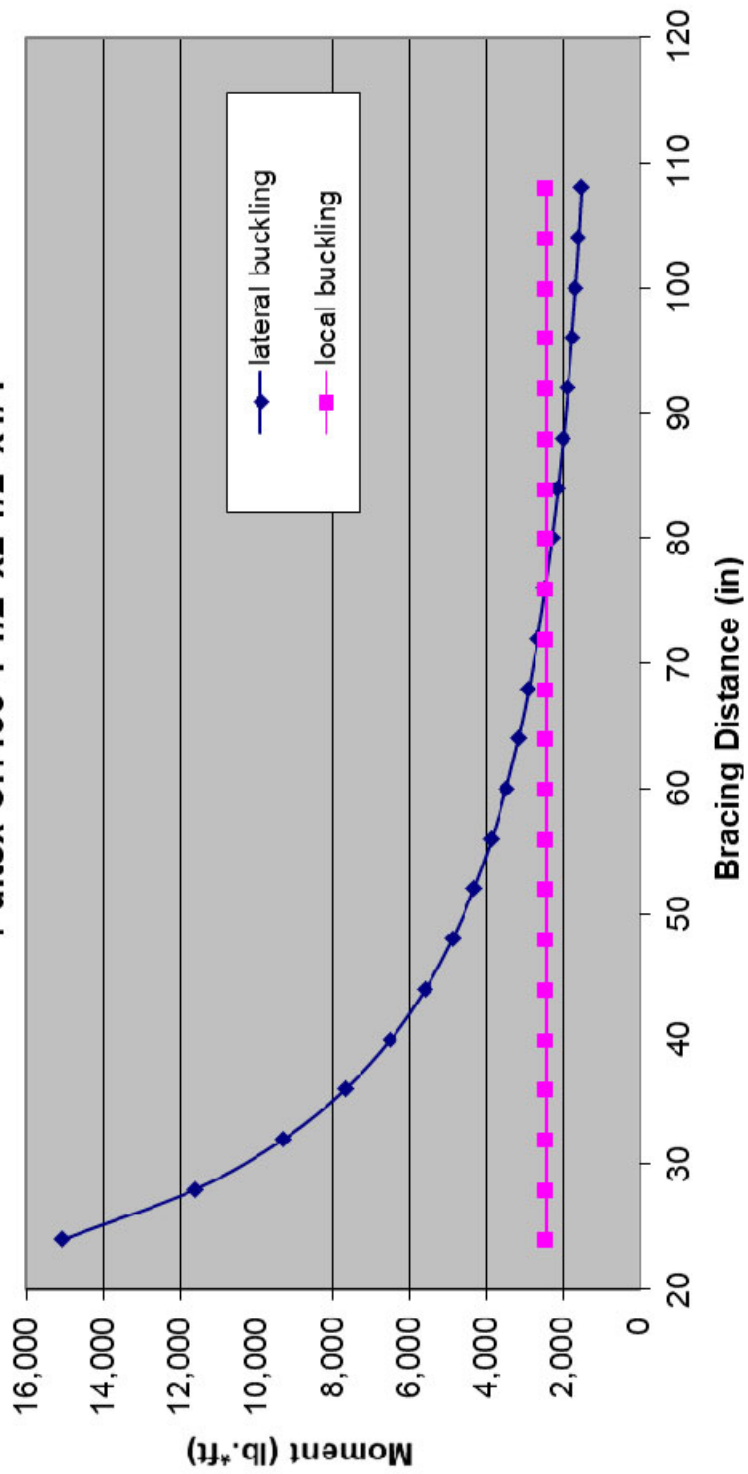

**Ultimate Moment Capacity V.S. Lateral Restraint
Pultex® CH540 5" x1 3/8" x1/4"**

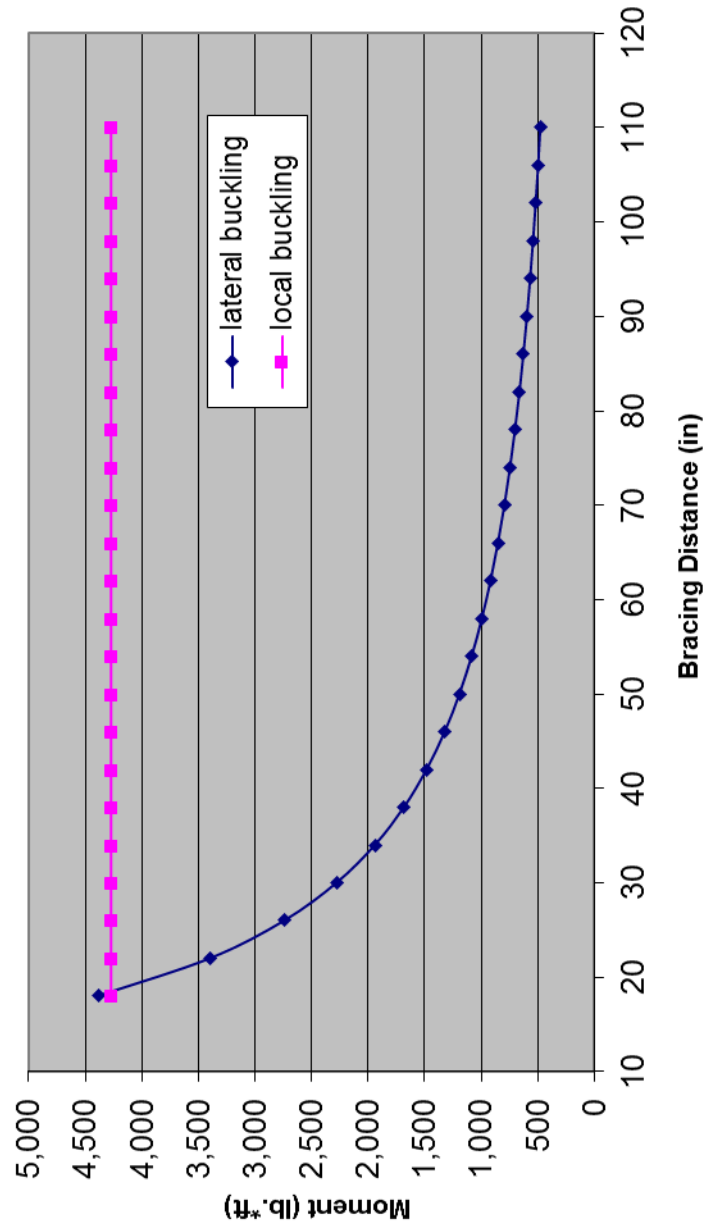

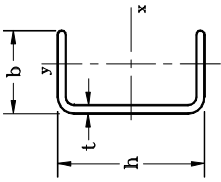

**PulTex Standard Structural Profiles
Channels**

Span (feet)	Number of lateral restraints per total span (Including Ends)	Maximum lateral support spacing (inches)	Simply Supported Beam with a Uniform Load				Simply Supported beam with Uniform Loads at various L/D ratios (lbs/ft)				
			Ultimate In-Plane Shear Stress (psi)	Ultimate Flexural Stress (psi)	Ultimate Local Flange Buckling Stress (psi)	Ultimate Lateral-torsional Buckling Stress with Maximum Lateral Support bracing (psi)	100	150	180	240	360
			7,000	33,000	17,228	17,344	****	****	****	****	****
6" x 1-5/8" x 1/4" (Part # CH 640) 1500/1525/1625 Series $E_y = 1.0 \times 10^6$ psi $G = 5.0 \times 10^5$ psi $S_x = 3.20$ in ³ $A_w = 1.50$ in ² $W_t = 1.75$ lbs/ft											
Load Tables Based on Laterally Supported Beams Unless Noted											
		Allowable load without lateral support 2.5x safety factor (lbs/ft)	Allowable load, local compression buckling capacity of flange, 2.5x safety factor (lbs/ft)	Allowable load based on the beam flexural capacity, 2.5x safety factor (lbs/ft)	Allowable load, In-plane shear parallel to the web, capacity, 3x safety factor (lbs/ft)						
2	2	1738	3683	7055	3500	****	****	****	****	3121	
3	3	505	1637	3136	2333	****	****	****	****	1167	
4	3	212	921	1764	1750	****	****	****	814	542	
5	3	108	589	1129	1400	****	****	****	583	291	
6	4	62	409	784	1167	****	****	****	346	173	
7	4	39	301	576	1000	****	****	****	266	111	
8	5	26	230	441	875	****	****	****	180	75	
9	5	18	182	348	778	****	****	****	128	53	
10	5	13	147	282	700	****	****	****	94	39	
11	6	10	122	233	636	****	****	****	71	29	
12	6	8	102	196	583	****	****	****	55	23	
13	7	6	87	167	538	****	****	****	43	18	
14	7	5	75	144	500	****	****	****	34	14	
15	7	4	65	125	467	****	****	****	28	12	
16	8	3	58	110	438	****	****	****	23	10	
17	8	3	51	98	412	****	****	****	19	8	
18	9	2	45	87	389	****	****	****	16	7	

Note: Bold numbers in the Factored Load Tables represent the governing load Reduction for weight of profile has not been applied to the charts

Ultimate Moment Capacity V.S. Lateral Restraint
 Pultex® CH640 6" x 1 5/8" x 1/4"

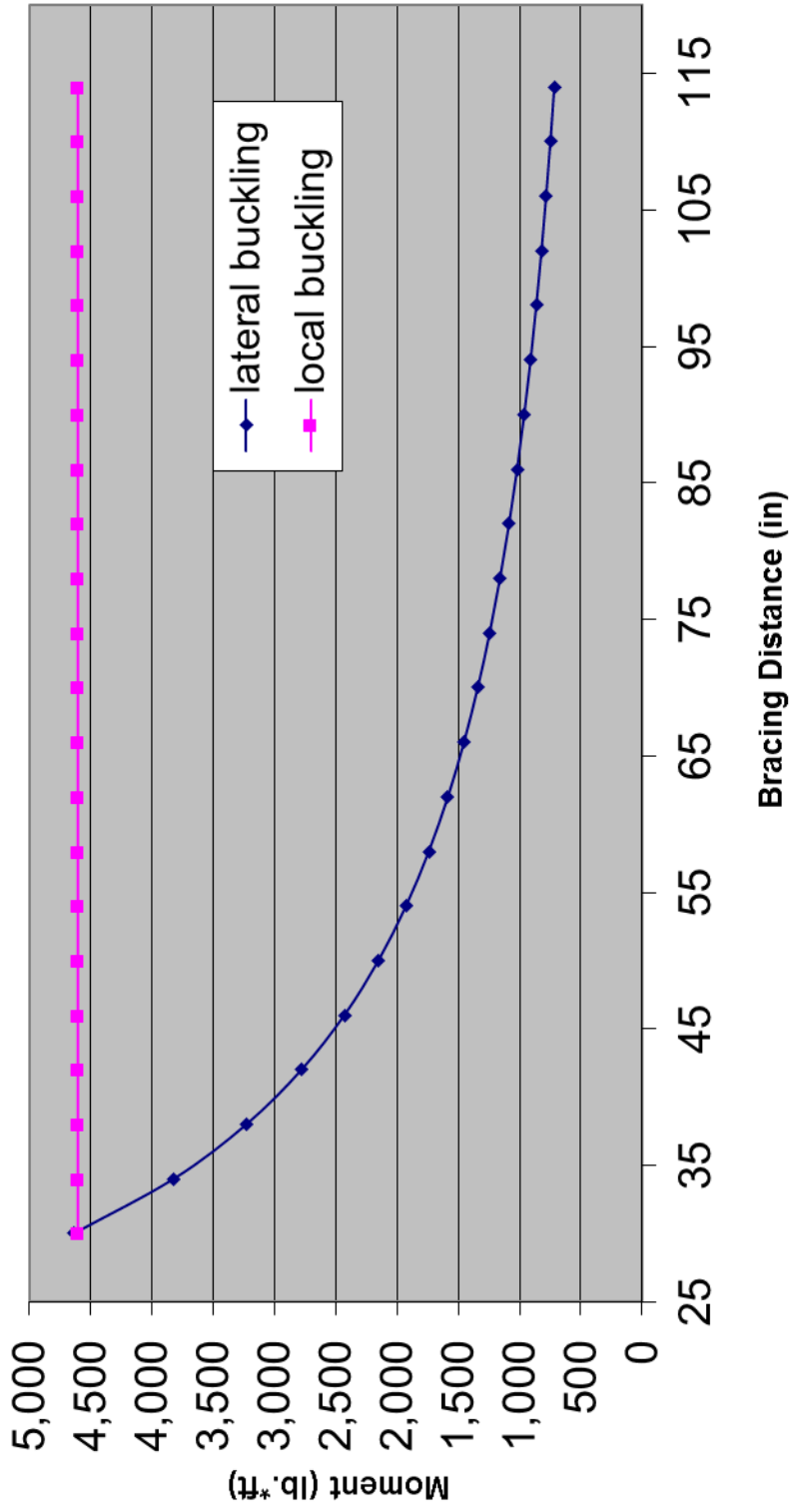

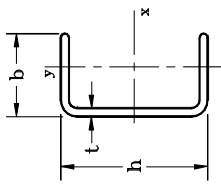

**PulTex Standard Structural Profiles
Channels**

6" x 1-11/16" x 3/8" (Part # CH 662) 1500/1525/1625 Series		Ultimate In-Plane Shear Stress (psi) Ultimate Flexural Stress (psi)		Simply Supported Beam with a Uniform Load		Simply Supported beam with Uniform Loads at various L/D ratios (lbs/ft)						
E _x =2.8x10 ⁶ psi I _x =13.42 in ⁴ A _w =2.25 in ²		E _y =1.0x10 ⁶ psi G =5.0x10 ⁵ psi S _x =4.47 in ³		7,000 33,000 34,272 38,167								
Wt.=2.61 lbs/ft		Load Tables Based on Laterally Supported Beams Unless Noted				Load Tables Based on Minimum Lateral Support L/D ratio						
Span (feet)	Number of lateral restraints per total span (Including Ends)	Maximum lateral support spacing (inches)	Load Tables Based on Laterally Supported Beams Unless Noted		Load Tables Based on Minimum Lateral Support L/D ratio							
			Allowable load without lateral support 2.5x safety factor (lbs/ft)	Allowable load, local compression buckling capacity of flange, 2.5x safety factor (lbs/ft)	Allowable load based on the beam flexural capacity, 2.5x safety factor (lbs/ft)	Allowable load, In-plane shear parallel to the web, capacity, 3x safety factor (lbs/ft)	100	150	180	240	360	
2	3	22	4019	10227	9848	5250	****	****	****	****	****	4472
3	3	22	1167	4545	4377	3500	****	****	****	****	****	1654
4	4	22	489	2557	2462	2625	****	****	****	****	****	764
5	4	22	249	1636	1576	2100	****	****	****	****	****	409
6	5	22	144	1136	1094	1750	****	****	****	****	****	243
7	5	22	91	835	804	1500	****	****	****	****	****	155
8	6	22	61	639	615	1313	****	****	****	****	****	105
9	6	22	43	505	486	1167	****	****	****	****	****	74
10	7	22	31	409	394	1050	****	****	****	****	****	54
11	7	22	23	338	326	955	****	****	****	****	****	41
12	8	22	18	284	274	875	****	****	****	****	****	32
13	9	22	14	242	233	808	****	****	****	****	****	25
14	9	22	11	209	201	750	****	****	****	****	****	20
15	10	22	9	182	175	700	****	****	****	****	****	16
16	10	22	8	160	154	656	****	****	****	****	****	13
17	11	22	6	142	136	618	****	****	****	****	****	11
18	11	22	5	126	122	583	****	****	****	****	****	9

Note: Bold numbers in the Factored Load Tables represent the governing load Reduction for weight of profile has not been applied to the charts

Ultimate Moment Capacity V.S. Lateral Restraint
 Pultex® CH662 6"x1 11/16"x3/8"

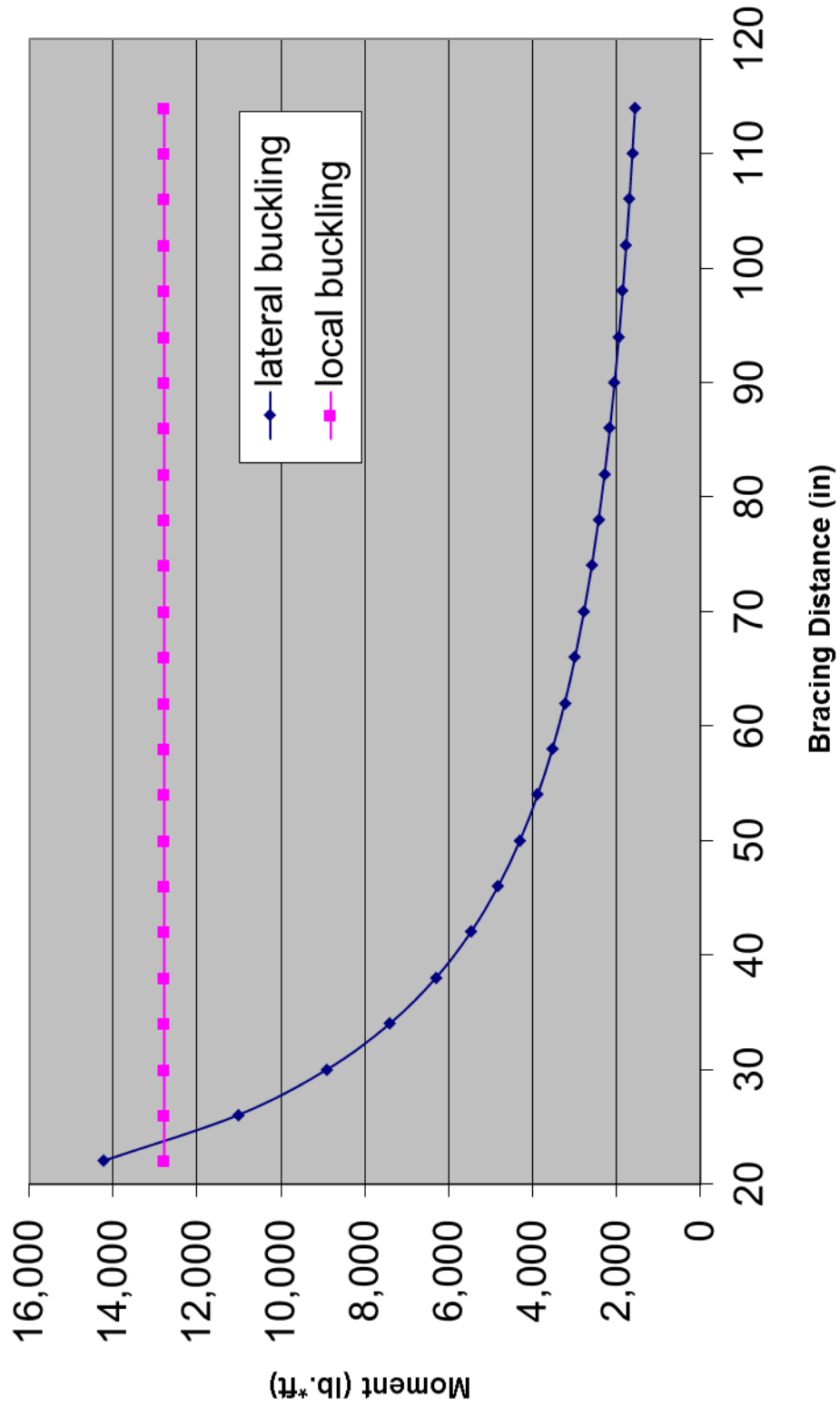

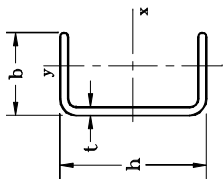

PulTex Standard Structural Profiles Channels

7" x 2" x 1/4" (Part # CH 740) 1500/1525/1625 Series		Ultimate In-Plane Shear Stress (psi) Ultimate Flexural Stress (psi)		Simply Supported Beam with a Uniform Load		Load Tables Based on Minimum Lateral Support L/D ratio					
E _y =2.8x10 ⁶ psi I _x =16.42 in ⁴ A _w =1.75 in ² E _y =1.0x10 ⁶ psi G =5.0x10 ⁵ psi S _x =4.69 in ³ Wt.=2.03 lbs/ft		Ultimate Local Flange Buckling Stress (psi) Ultimate Lateral-torsional Buckling Stress with Maximum Lateral Support bracing (psi)		Load Tables Based on Laterally Supported Beams Unless Noted		Simply Supported beam with Uniform Loads at various L/D ratios (lbs/ft)					
Span (feet)	Number of lateral restraints per total span (Including Ends)	Maximum lateral support spacing (inches)	Allowable load without lateral support 2.5x safety factor (lbs/ft)	Load Tables Based on Laterally Supported Beams Unless Noted		100	150	180	240	360	
				Allowable load, local compression buckling capacity of flange, 2.5x safety factor (lbs/ft)	Allowable load based on the beam flexural capacity, 2.5x safety factor (lbs/ft)						Allowable load, In-plane shear parallel to the web, capacity, 3x safety factor (lbs/ft)
5	3	46	166	531	1651	1633	*****	*****	*****	*****	*****
6	3	46	96	369	1146	1361	*****	*****	*****	*****	*****
7	3	46	60	271	842	1167	*****	*****	*****	*****	*****
8	4	46	40	207	645	1021	*****	*****	*****	*****	*****
9	4	46	28	164	510	907	*****	*****	*****	*****	*****
10	4	46	21	133	413	817	*****	*****	*****	*****	*****
11	4	46	16	110	341	742	*****	*****	*****	*****	*****
12	5	46	12	92	287	681	*****	*****	*****	*****	*****
13	5	46	9	79	244	628	*****	*****	*****	*****	*****
14	5	46	8	68	211	583	*****	*****	*****	*****	*****
15	5	46	6	59	183	544	*****	*****	*****	*****	*****
16	6	46	5	52	161	510	*****	*****	*****	*****	*****
17	6	46	4	46	143	480	*****	*****	*****	*****	*****
18	6	46	4	41	127	454	*****	*****	*****	*****	*****
19	6	46	3	37	114	430	*****	*****	*****	*****	*****
20	7	46	3	33	103	408	*****	*****	*****	*****	*****

Note: Bold numbers in the Factored Load Tables represent the governing load
Reduction for weight of profile has not been applied to the charts

**Ultimate Moment Capacity V.S. Lateral Restraint
Pultex® CH740 7"x2"x1/4"**

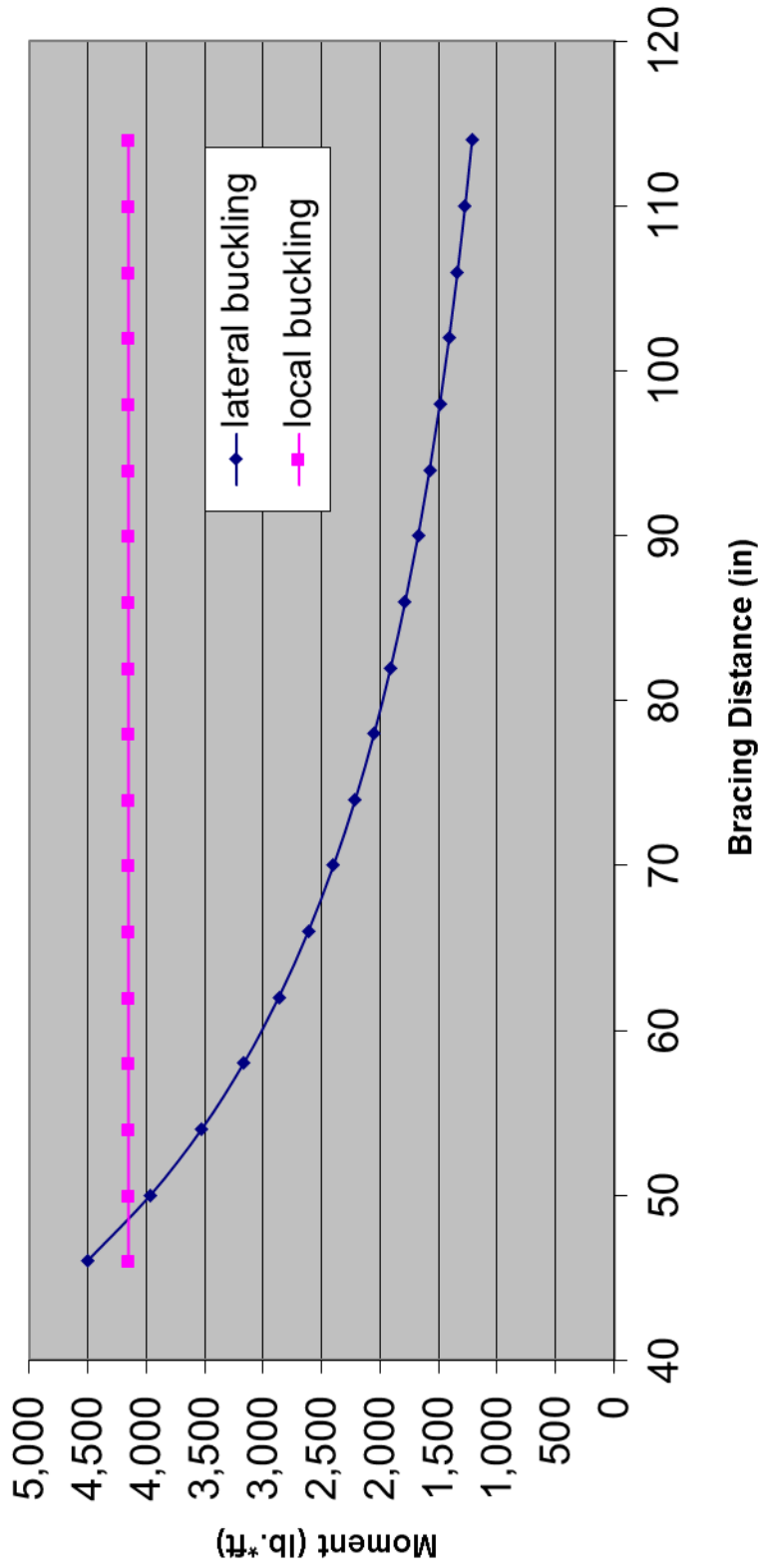

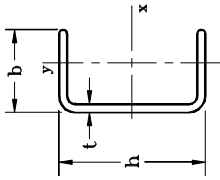

**PuTEx Standard Structural Profiles
Channels**

14" x 6" x 1/2" (Part # CH 802)		Ultimate In-Plane Shear Stress (psi)		Simply Supported Beam with a Uniform Load		Simply Supported beam with Uniform Loads at various L/D ratios (lbs/ft)				
1625 Series		Ultimate Flexural Stress (psi)		Load Tables Based on Laterally Supported Beams Unless Noted		Load Tables Based on Minimum Lateral Support L/D ratio				
Span (feet)	Number of lateral restraints per total span (Including Ends)	Maximum lateral support spacing (inches)	Load Tables Based on Laterally Supported Beams Unless Noted		Allowable load, In-plane shear parallel to the web, capacity, 3x safety factor (lbs/ft)	100	150	180	240	360
			Allowable load, local compression buckling capacity of flange, 2.5x safety factor (lbs/ft)	Allowable load based on the beam flexural capacity, 2.5x safety factor (lbs/ft)						
8	2	207	1352	6857	4083	****	****	****	****	****
9	2	207	1068	5418	3630	****	****	****	****	****
10	2	207	865	4388	3267	****	****	****	****	****
11	2	207	715	3627	2970	****	****	****	****	****
12	2	207	601	3048	2722	****	****	****	****	****
13	2	207	512	2597	2513	****	****	****	****	****
14	2	207	441	2239	2333	****	****	****	****	****
15	2	207	385	1950	2178	****	****	****	****	****
16	2	207	338	1714	2042	****	****	****	****	****
17	2	207	299	1519	1922	****	****	****	****	****
18	3	207	267	1354	1815	****	****	****	****	****
19	3	207	240	1216	1719	****	****	****	****	****
20	3	207	216	1097	1633	****	****	****	****	****
21	3	207	196	995	1556	****	****	****	****	****
22	3	207	179	907	1485	****	****	****	****	****

Note: Bold numbers in the Factored Load Tables represent the governing load Reduction for weight of profile has not been applied to the charts

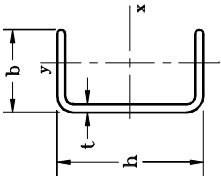

**PuTEx Standard Structural Profiles
Channels**

14" x 6" x 1/2" (Part # CH 802)		Ultimate In-Plane Shear Stress (psi)		Simply Supported Beam with a Uniform Load		Simply Supported beam with Uniform Loads at various L/D ratios (lbs/ft)								
1625 Series		Ultimate Flexural Stress (psi)		Load Tables Based on Laterally Supported Beams Unless Noted		Load Tables Based on Minimum Lateral Support L/D ratio								
Span (feet)	Number of lateral restraints per total span (Including Ends)	Maximum lateral support spacing (inches)	Load Tables Based on Laterally Supported Beams Unless Noted		Allowable load based on the beam flexural capacity, 2.5x safety factor (lbs/ft)	Allowable local compression buckling capacity of flange, 2.5x safety factor (lbs/ft)	Allowable load without lateral support 2.5x safety factor (lbs/ft)	Allowable load, compression buckling capacity of web, 2.5x safety factor (lbs/ft)	Allowable load, In-plane shear parallel to the web, capacity, 3x safety factor (lbs/ft)	100	150	180	240	360
			Allowable load, compression buckling capacity of flange, 2.5x safety factor (lbs/ft)	Allowable load, In-plane shear parallel to the web, capacity, 3x safety factor (lbs/ft)										
23	3	207	61	164	830	1420	1420	1420	1420	****	****	****	****	****
24	3	207	54	150	762	1361	1361	1361	1361	****	****	****	****	****
25	3	207	48	138	702	1307	1307	1307	1307	****	****	****	****	****
26	3	207	42	128	649	1256	1256	1256	1256	****	****	****	****	****
27	3	207	38	119	602	1210	1210	1210	1210	****	****	****	****	****
28	3	207	34	110	560	1167	1167	1167	1167	****	****	****	****	****
29	3	207	30	103	522	1126	1126	1126	1126	****	****	****	****	****
30	3	207	28	96	488	1089	1089	1089	1089	****	****	****	****	****
31	3	207	25	90	457	1054	1054	1054	1054	****	****	****	****	****
32	3	207	23	84	429	1021	1021	1021	1021	****	****	****	****	****
33	3	207	21	79	403	990	990	990	990	****	****	****	****	****
34	3	207	19	75	380	961	961	961	961	****	****	****	****	****
35	4	207	17	71	358	933	933	933	933	****	****	****	****	****

Note: Bold numbers in the Factored Load Tables represent the governing load Reduction for weight of profile has not been applied to the charts

Ultimate Moment Capacity V.S. Lateral Restraint Pultex® CH800 14" x6" x1/2"

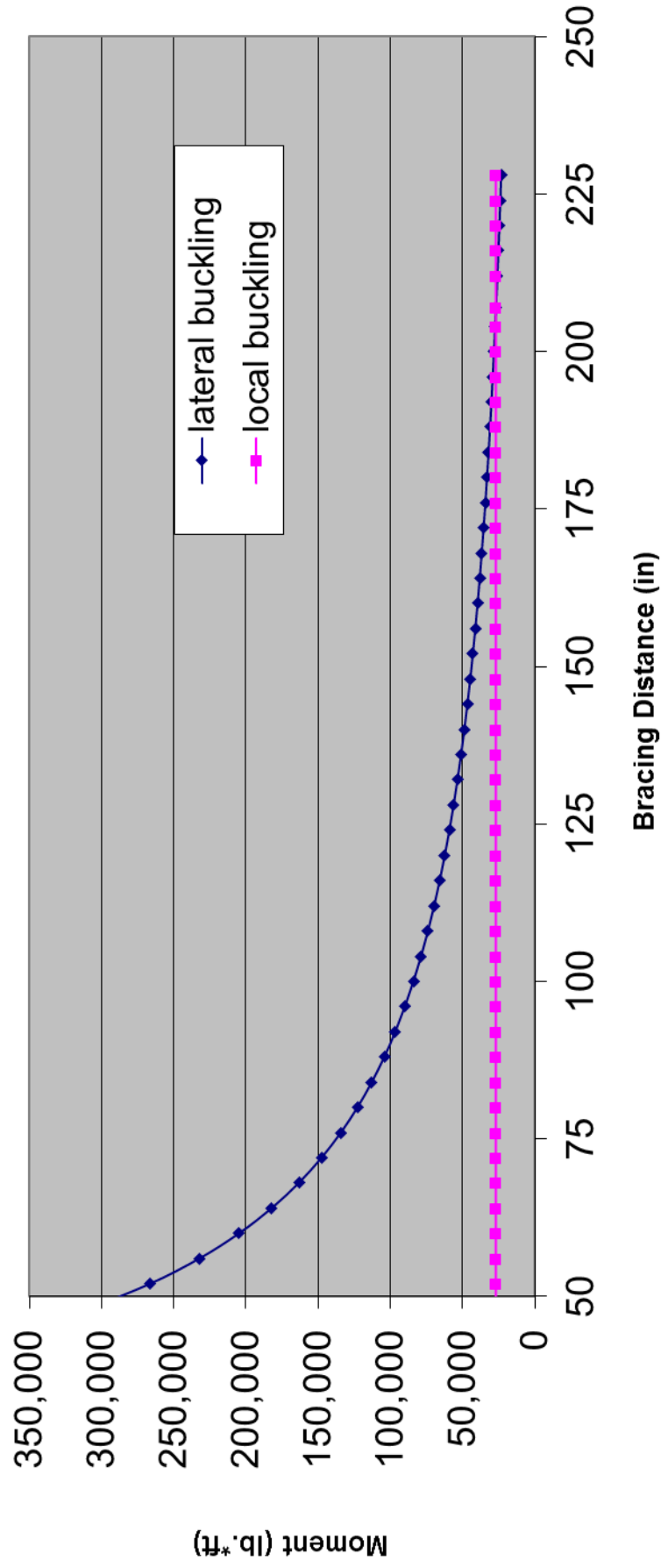

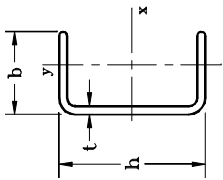

**PulTex Standard Structural Profiles
Channels**

8" x 2-3/16" x 1/4" (Part # CH 840) 1500/1525/1625 Series $E_y = 2.8 \times 10^6$ psi $I_x = 24.30$ in ⁴ $A_w = 2.0$ in ² $E_y = 1.0 \times 10^6$ psi $G = 5.0 \times 10^5$ psi $S_x = 6.07$ in ³ Wt. = 2.42 lbs/ft		Ultimate In-Plane Shear Stress (psi)		Ultimate Flexural Stress (psi)		Ultimate Local Flange Buckling Stress (psi)		Ultimate Lateral-torsional Buckling Stress with Maximum Lateral Support bracing (psi)		Simply Supported Beam with a Uniform Load				
		7,000 33,000 9,396 10,158								Load Tables Based on Laterally Supported Beams Unless Noted				
Span (feet)	Number of lateral restraints per total span (Including Ends)	Maximum lateral support spacing (inches)	Load Tables Based on Laterally Supported Beams Unless Noted		Simply Supported Beam with a Uniform Load		Load Tables Based on Minimum Lateral Support L/D ratio							
			Allowable load, local compression buckling capacity of flange, 2.5x safety factor (lbs/ft)	Allowable load based on the beam flexural capacity, 2.5x safety factor (lbs/ft)	Allowable load without lateral support 2.5x safety factor (lbs/ft)	Allowable local compression buckling capacity of flange, 2.5x safety factor (lbs/ft)	Allowable load based on the beam flexural capacity, 2.5x safety factor (lbs/ft)	Allowable load, In-plane shear parallel to the web, capacity, 3x safety factor (lbs/ft)	100	150	180	240	360	
6	3	52	423	1485	118	1556	1485	1556	****	****	****	****	****	****
7	3	52	311	1091	74	1333	1091	1333	****	****	****	****	****	****
8	3	52	238	835	50	1167	835	1167	****	****	****	****	****	****
9	4	52	188	660	35	1037	660	1037	****	****	****	****	****	****
10	4	52	152	535	25	933	535	933	****	****	****	****	****	****
11	4	52	126	442	19	848	442	848	****	****	****	****	****	****
12	4	52	106	371	15	778	371	778	****	****	****	****	****	****
13	4	52	90	316	12	718	316	718	****	****	89	67	45	****
14	5	52	78	273	9	667	273	667	****	****	72	54	36	****
15	5	52	68	238	8	622	238	622	****	****	59	44	29	****
16	5	52	59	209	6	583	209	583	****	****	48	36	24	****
17	5	52	53	185	5	549	185	549	****	****	40	30	20	****
18	6	52	47	165	4	519	165	519	****	****	34	26	17	****
19	6	52	42	148	4	491	148	491	****	****	29	22	15	****
20	6	52	38	134	3	467	134	467	****	****	25	19	12	****
21	6	52	35	121	3	444	121	444	****	****	22	16	11	****
22	7	52	31	110	2	424	110	424	****	****	19	14	9	****

Note: Bold numbers in the Factored Load Tables represent the governing load Reduction for weight of profile has not been applied to the charts

**Ultimate Moment Capacity V.S. Lateral Restraint
Pultex® CH840 8" x 2-3/16" x 1/4"**

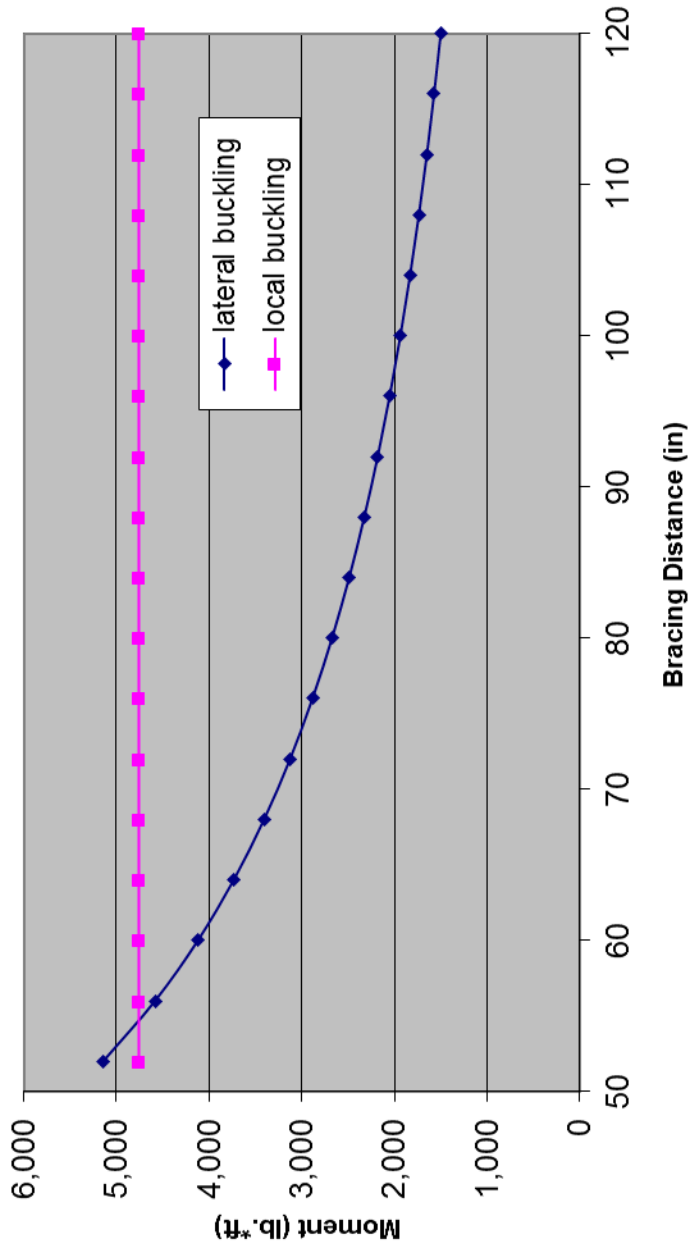

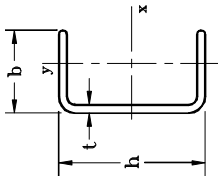

PulTex Standard Structural Profiles Channels

8" x 2-3/16" x 3/8" (Part # CH 860) 1500/1525/1625 Series		Ultimate In-Plane Shear Stress (psi) Ultimate Flexural Stress (psi)		Simply Supported Beam with a Uniform Load		Load Tables Based on Minimum Lateral Support L/D ratio								
E _y = 2.8x10 ⁶ psi I _x = 33.75 in ⁴ A _w = 3.0 in ² E _y = 1.0x10 ⁶ psi G = 5.0x10 ⁵ psi S _x = 8.43 in ³ Wt. = 3.57 lbs/ft		Ultimate Local Flange Buckling Stress (psi) Ultimate Lateral-torsional Buckling Stress with Maximum Lateral Support bracing (psi)		Simply Supported Beams with a Uniform Load		Load Tables Based on Minimum Lateral Support L/D ratio								
Span (feet)	Number of lateral restraints per total span (Including Ends)	Maximum lateral support spacing (inches)	Load Tables Based on Laterally Supported Beams Unless Noted					Simply Supported beam with Uniform Loads at various L/D ratios (lbs/ft)						
			Allowable load without lateral support 2.5x safety factor (lbs/ft)	Allowable local compression buckling capacity of flange, 2.5x safety factor (lbs/ft)	Allowable load based on the beam flexural capacity, 2.5x safety factor (lbs/ft)	Allowable load, In-plane shear parallel to the web, capacity, 3x safety factor (lbs/ft)	100	150	180	240	360			
4	3	37	869	2970	4637	3500	****	****	****	****	****	****	****	****
6	3	37	255	1320	2061	2333	****	****	****	****	****	****	****	****
8	4	37	107	742	1159	1750	****	****	****	****	****	****	****	****
10	5	37	55	475	742	1400	****	****	****	****	****	****	****	****
12	5	37	32	330	515	1167	****	****	****	****	****	****	****	****
14	6	37	20	242	378	1000	****	****	****	****	****	****	****	****
16	7	37	13	186	290	875	****	****	****	****	****	****	****	****
18	7	37	9	147	229	778	****	****	****	****	****	****	****	****
20	8	37	7	119	185	700	****	****	****	****	****	****	****	****
22	9	37	5	98	153	636	****	****	****	****	****	****	****	****
24	9	37	4	82	129	583	****	****	****	****	****	****	****	****

**Note: Bold numbers in the Factored Load Tables represent the governing load
Reduction for weight of profile has not been applied to the charts**

Ultimate Moment Capacity V.S. Lateral Restraint Pultex® CH860 8" x 2-3/16" x 3/8"

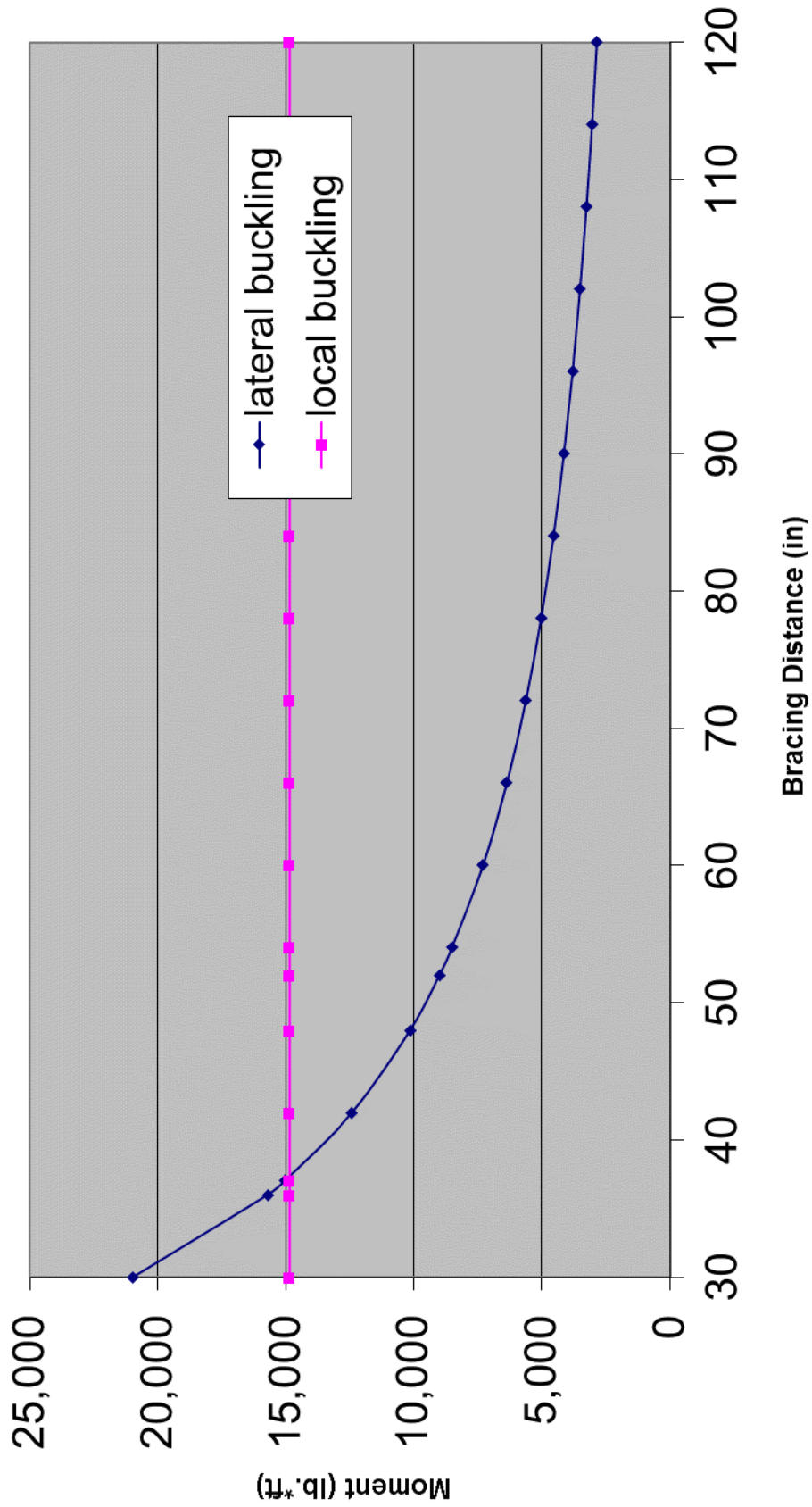

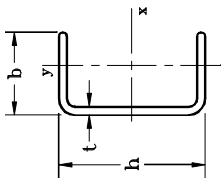

PulTex Standard Structural Profiles
Channels

11-1/2" x 2-3/4" x 1/2" (Part # CH 995) 1500/1525/1625 Series		Ultimate In-Plane Shear Stress (psi) Ultimate Flexural Stress (psi)		Simply Supported Beam with a Uniform Load		Simply Supported beam with Uniform Loads at various L/D ratios (lbs/ft)						
E _x =2.8x10 ⁶ psi I _x =124.58 in ⁴ A _w =5.75 in ²		E _y =1.0x10 ⁶ psi G =5.0x10 ⁵ psi S _x =21.67 in ³ Wt.=6.69 lbs/ft		Ultimate Local Flange Buckling Stress (psi) Ultimate Lateral-torsional Buckling Stress with Maximum Lateral Support bracing (psi)		7,000 33,000 27,046 30,452						
Span (feet)	Number of lateral restraints per total span (Including Ends)	Maximum lateral support spacing (inches)	Load Tables Based on Laterally Supported Beams Unless Noted			Load Tables Based on Minimum Lateral Support L/D ratio						
			Allowable load without lateral support 2.5x safety factor (lbs/ft)	Allowable load, local compression buckling capacity of flange, 2.5x safety factor (lbs/ft)	Allowable load based on the beam flexural capacity, 2.5x safety factor (lbs/ft)	Allowable load, In-plane shear parallel to the web, capacity, 3x safety factor (lbs/ft)	100	150	180	240	360	
4	3	36	2641	9767	11917	6708	****	****	****	****	****	****
6	3	36	770	4341	5296	4472	****	****	****	****	****	****
8	4	36	323	2442	2979	3354	****	****	****	****	****	****
10	5	36	165	1563	1907	2683	****	****	****	****	****	****
12	5	36	95	1085	1324	2236	****	****	****	****	****	****
14	6	36	60	797	973	1917	****	****	****	****	****	****
16	7	36	40	610	745	1677	****	****	****	****	****	****
18	7	36	28	482	588	1491	****	****	****	****	****	****
20	8	36	21	391	477	1342	****	****	****	****	****	****
22	9	36	15	323	394	1220	****	****	****	****	****	****
24	9	36	12	271	331	1118	****	****	****	****	****	****
26	10	36	9	231	282	1032	****	****	****	****	****	****
28	11	36	7	199	243	958	****	****	****	****	****	****
30	11	366	6	174	212	894	****	****	****	****	****	****
32	12	36	5	153	186	839	****	****	****	****	****	****
34	13	36	4	135	165	789	****	****	****	****	****	****
36	13	36	4	121	147	745	****	****	****	****	****	****

Note: Bold numbers in the Factored Load Tables represent the governing load Reduction for weight of profile has not been applied to the charts

Ultimate Moment Capacity V.S. Lateral Restraint Pultex® CH955 11.5" x 2-3/4" x 1/2"

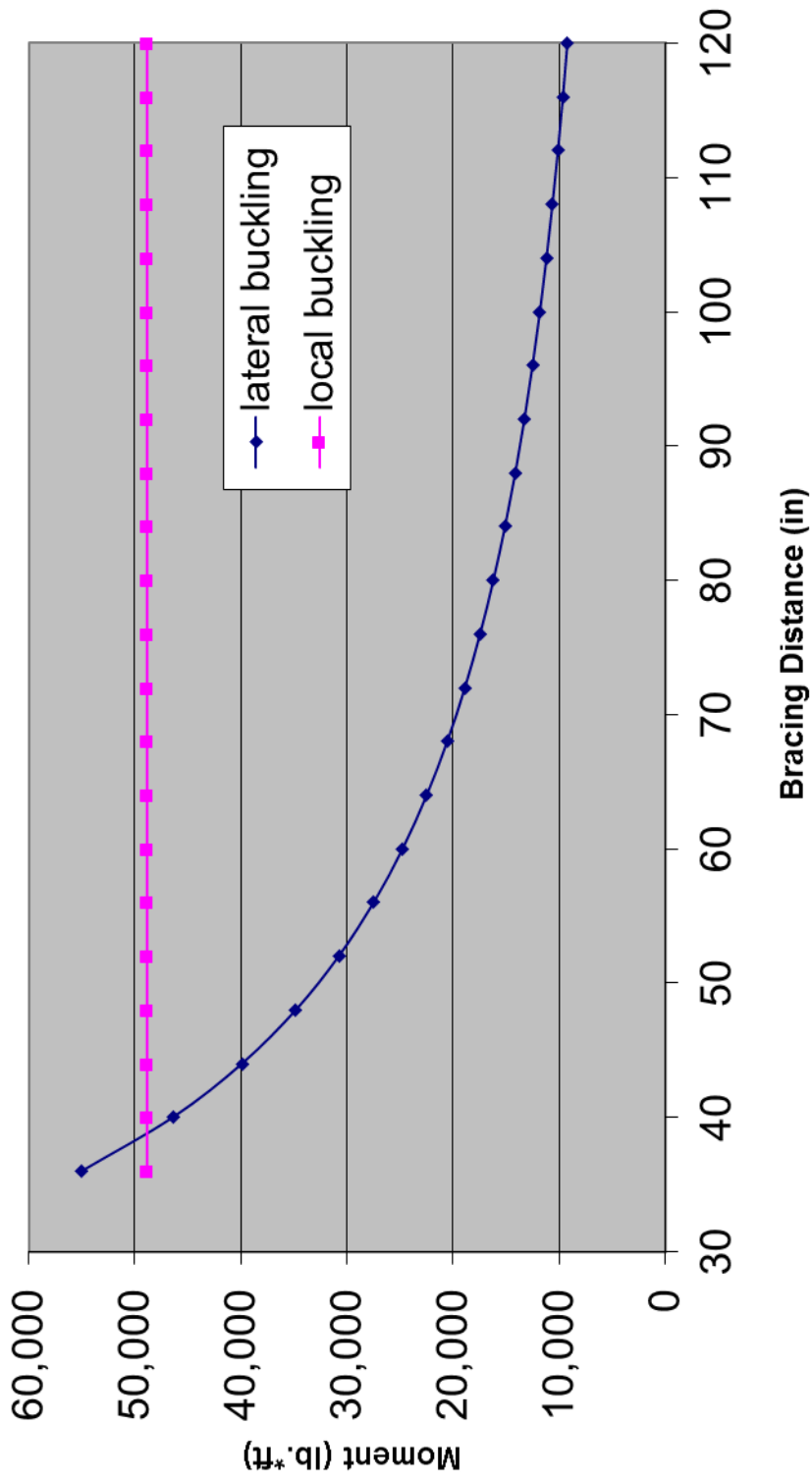

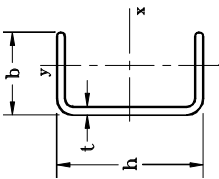

PulTex Standard Structural Profiles Channels

10" x 2-3/4" x 1/2" SuperStructural (Part # CH 980) 1500/1525/1625 Series $E_y = 1.5 \times 10^6$ psi $I_x = 86.87$ in ⁴ $A_w = 5.0$ in ² $E_y = 1.5 \times 10^6$ psi $G = 5.0 \times 10^5$ psi $S_x = 17.37$ in ³ Wt. = 5.94 lbs/ft		Ultimate In-Plane Shear Stress (psi)		Ultimate Flexural Stress (psi)		Simply Supported Beam with a Uniform Load		Load Tables Based on Minimum Lateral Support L/D ratio						
		Simply Supported Beam with a Uniform Load		Load Tables Based on Laterally Supported Beams Unless Noted		Simply Supported Beam with a Uniform Load								
Span (feet)	Number of lateral restraints per total span (Including Ends)	Maximum lateral support spacing (inches)	Load Tables Based on Laterally Supported Beams Unless Noted		Simply Supported Beam with a Uniform Load		Simply Supported beam with Uniform Loads at various L/D ratios (lbs/ft)							
			Allowable load without lateral support 2.5x safety factor (lbs/ft)	Allowable load, local compression buckling capacity of flange, 2.5x safety factor (lbs/ft)	Allowable load based on the beam flexural capacity, 2.5x safety factor (lbs/ft)	Allowable load, In-plane shear parallel to the web, capacity, 3x safety factor (lbs/ft)	100	150	180	240	360			
4	2	52	2632	5870	9554	5833	****	****	****	****	****	****	****	****
6	3	52	770	2609	4246	3889	****	****	****	****	****	****	****	****
8	3	52	323	1468	2388	2917	****	****	****	****	****	****	****	****
10	4	52	165	939	1529	2333	****	****	****	****	****	****	****	****
12	4	52	95	652	1062	1944	****	****	****	****	****	****	****	****
14	5	52	60	479	780	1667	****	****	****	****	****	****	****	****
16	5	52	40	367	597	1458	****	****	****	****	****	****	****	****
18	6	52	28	290	472	1296	****	****	****	****	****	****	****	****
20	6	52	21	235	382	1167	****	****	****	****	****	****	****	****
22	7	52	15	194	316	1061	****	****	****	****	****	****	****	****
24	7	52	12	163	265	972	****	****	****	****	****	****	****	****
26	7	52	9	139	226	897	****	****	****	****	****	****	****	****
28	8	52	7	120	195	833	****	****	****	****	****	****	****	****
30	8	52	6	104	170	778	****	****	****	****	****	****	****	****
32	9	52	5	92	149	729	****	****	****	****	****	****	****	****
34	9	52	4	81	132	686	****	****	****	****	****	****	****	****
36	10	52	4	72	118	648	****	****	****	****	****	****	****	****

Note: Bold numbers in the Factored Load Tables represent the governing load Reduction for weight of profile has not been applied to the charts

Ultimate Moment Capacity V.S. Lateral Restraint Pultex® CH980 10" x 2-3/4" x 1/2"

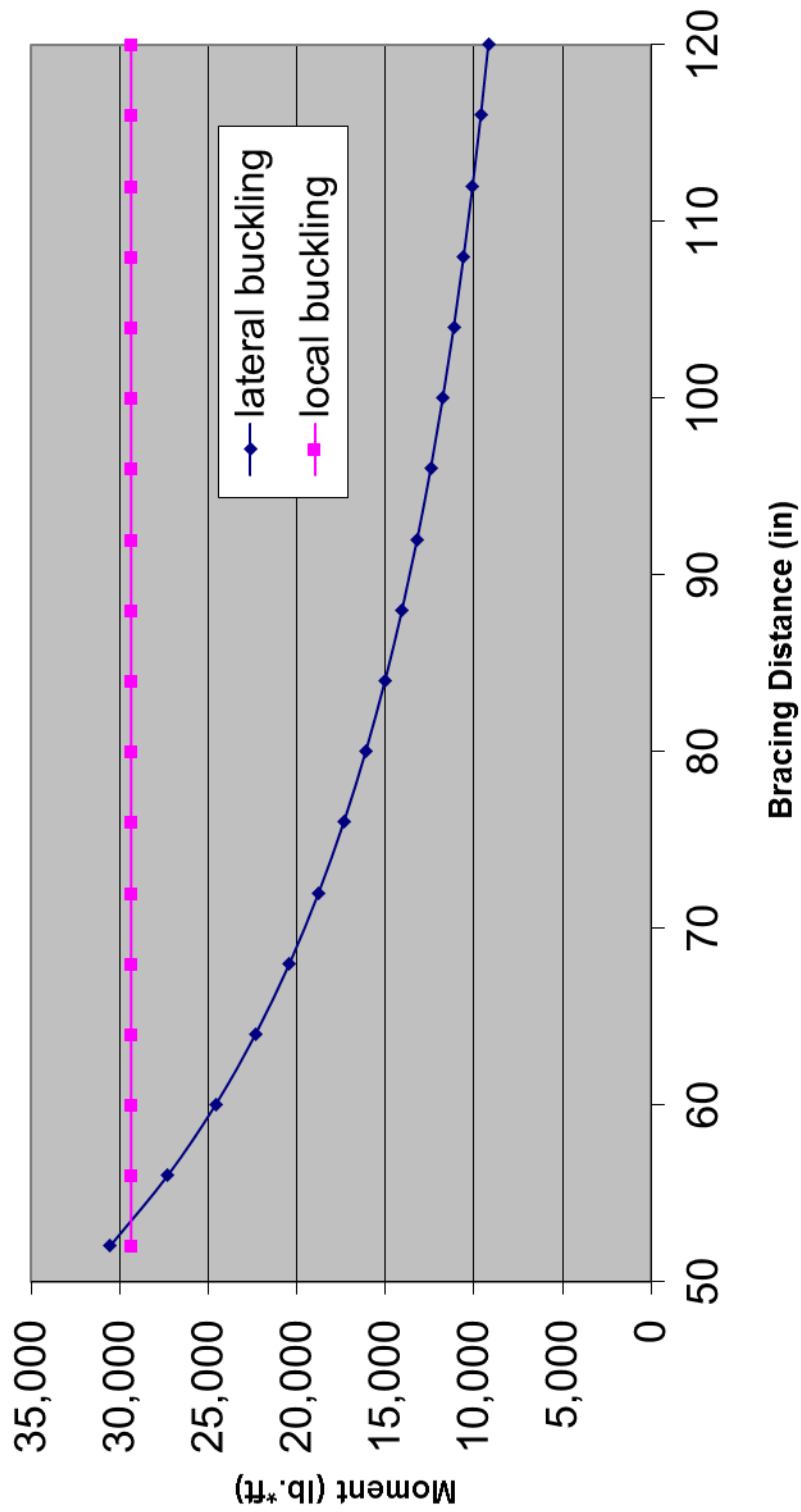

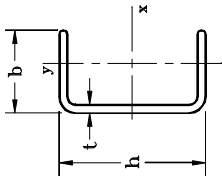

PulTex Standard Structural Profiles Channels

24" x 4" x 15/32" (Part # CH 994) 1500/1525/1625 Series $E_y = 2.8 \times 10^6$ psi $I_x = 985.10$ in ⁴ $A_w = 11.32$ in ² $E_y = 1.0 \times 10^6$ psi $G = 5.0 \times 10^5$ psi $S_x = 82.0$ in ³ Wt. = 11.88 lbs/ft		Ultimate In-Plane Shear Stress (psi)		Ultimate Flexural Stress (psi)		Simply Supported Beam with a Uniform Load		Simply Supported beam with Uniform Loads at various L/D ratios (lbs/ft)						
		Ultimate Local Flange Buckling Stress (psi)		Ultimate Lateral-torsional Buckling Stress with Maximum Lateral Support bracing (psi)		7,000 33,000 14,184 14,419		Load Tables Based on Minimum Lateral Support L/D ratio						
Span (feet)	Number of lateral restraints per total span (Including Ends)	Maximum lateral support spacing (inches)	Load Tables Based on Laterally Supported Beams Unless Noted											
			Allowable load without lateral support 2.5x safety factor (lbs/ft)	Allowable local compression buckling capacity of flange, 2.5x safety factor (lbs/ft)	Allowable load based on the beam flexural capacity, 2.5x safety factor (lbs/ft)	Allowable load, In-plane shear parallel to the web, capacity, 3x safety factor (lbs/ft)	100	150	180	240	360			
10	3	64	387	3102	7216	5286	****	****	****	****	****	****	****	****
12	4	64	223	2154	5011	4405	****	****	****	****	****	****	****	****
14	4	64	140	1582	3682	3776	****	****	****	****	****	****	****	****
16	4	64	93	1212	2819	3304	****	****	****	****	****	****	****	****
18	5	64	65	957	2227	2937	****	****	****	****	****	****	****	****
20	5	64	48	775	1804	2643	****	****	****	****	****	****	****	****
22	6	64	36	641	1491	2403	****	****	****	****	****	****	****	****
24	6	64	28	538	1253	2203	****	****	****	****	****	****	****	****
26	6	64	22	459	1067	2033	****	****	****	****	****	****	****	****
28	7	64	17	396	920	1888	****	****	****	****	****	****	****	****
30	7	64	14	345	802	1762	****	****	****	****	****	****	****	****
32	7	64	12	303	705	1652	****	****	****	****	****	****	****	****
34	8	64	10	268	624	1555	****	****	****	****	****	****	****	****
36	8	64	8	239	557	1468	****	****	****	****	****	****	****	****
38	9	64	7	215	500	1391	****	****	****	****	****	****	****	****
40	9	64	6	194	451	1322	****	****	****	****	****	****	****	****

Note: Bold numbers in the Factored Load Tables represent the governing load Reduction for weight of profile has not been applied to the charts

Moment Capacity V.S. Lateral Restraint Pultex® CH994 24" x 4" x 15/32"

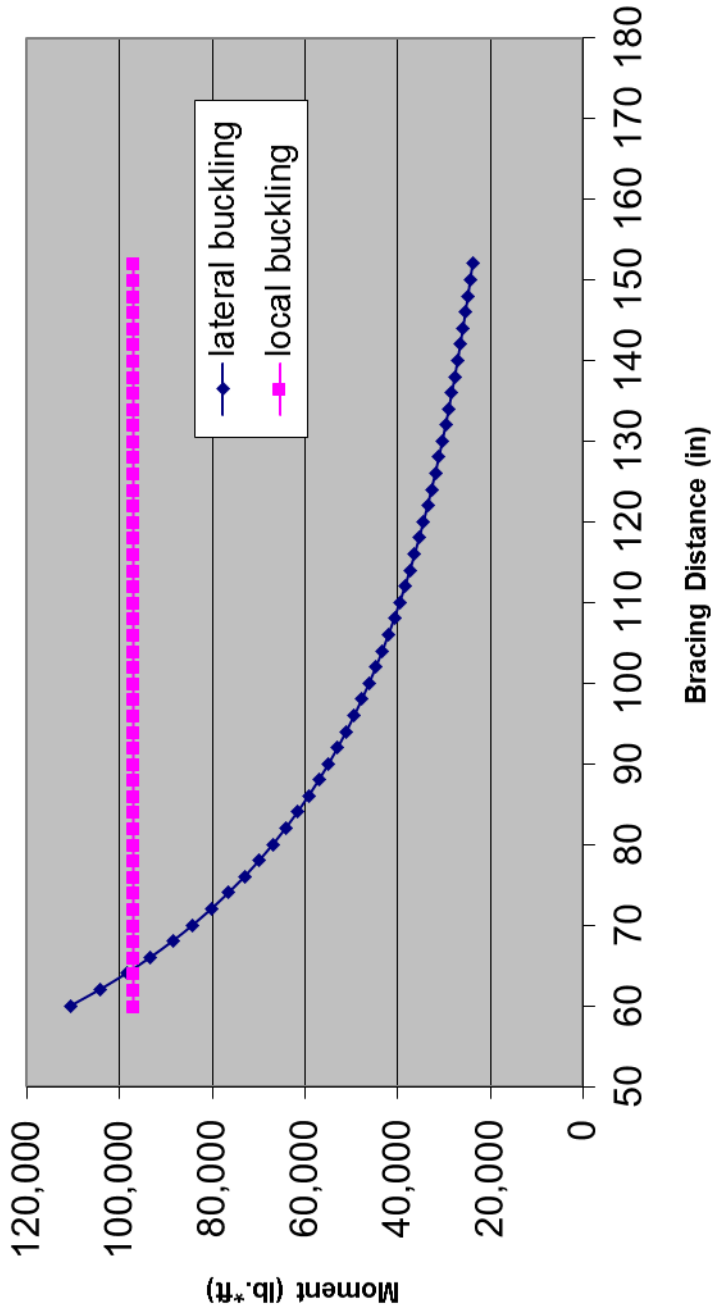

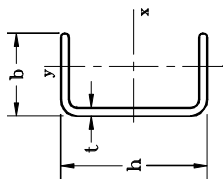

**PulTex Standard Structural Profiles
Channels**

Span (feet)	Number of lateral restraints per total span (Including Ends)	Maximum lateral support spacing (inches)	Simply Supported Beam with a Uniform Load				7,000 33,000 11,064 32,750	Load Tables Based on Minimum Lateral Support L/D ratio						
			Load Tables Based on Laterally Supported Beams Unless Noted		Allowable load, In-plane shear parallel to the web, capacity, 3x safety factor (lbs/ft)	Simply Supported beam with Uniform Loads at various L/D ratios (lbs/ft)								
			Allowable load, local compression buckling capacity of flange, 2.5x safety factor (lbs/ft)	Allowable load without lateral support 2.5x safety factor (lbs/ft)		Allowable load based on the beam flexural capacity, 2.5x safety factor (lbs/ft)		100	150	180	240	360		
10	6	24	671	46	2002	2100	****	****	****	****	****	****	****	****
12	7	24	466	26	1390	1750	****	****	****	****	****	****	****	****
14	8	24	342	17	1021	1500	****	****	****	****	****	****	****	****
16	9	24	262	11	782	1313	****	****	****	****	****	****	****	****
18	10	24	207	8	618	1167	****	****	****	****	****	****	****	****
20	11	24	168	6	501	1050	****	****	****	****	****	****	****	****
22	12	24	139	4	414	955	****	****	****	****	****	****	****	****
24	13	24	117	3	348	875	****	****	****	****	****	****	****	****
26	14	24	99	3	296	808	****	****	****	****	****	****	****	****
28	15	24	86	2	255	750	****	****	****	****	****	****	****	****
30	16	24	75	2	222	700	****	****	****	****	****	****	****	****
32	17	24	66	1	196	656	****	****	****	****	****	****	****	****
34	18	24	58	1	173	618	****	****	****	****	****	****	****	****
36	19	24	52	1	154	583	****	****	****	****	****	****	****	****
38	20	24	46	1	139	553	****	****	****	****	****	****	****	****
40	21	24	42	1	125	525	****	****	****	****	****	****	****	****
42	22	24	38	1	113	500	****	****	****	****	****	****	****	****

Note: Bold numbers in the Factored Load Tables represent the governing load Reduction for weight of profile has not been applied to the charts

Moment Capacity V.S. Lateral Restraint Pultex® CH810 18" x 2-1/2" x 1/4"

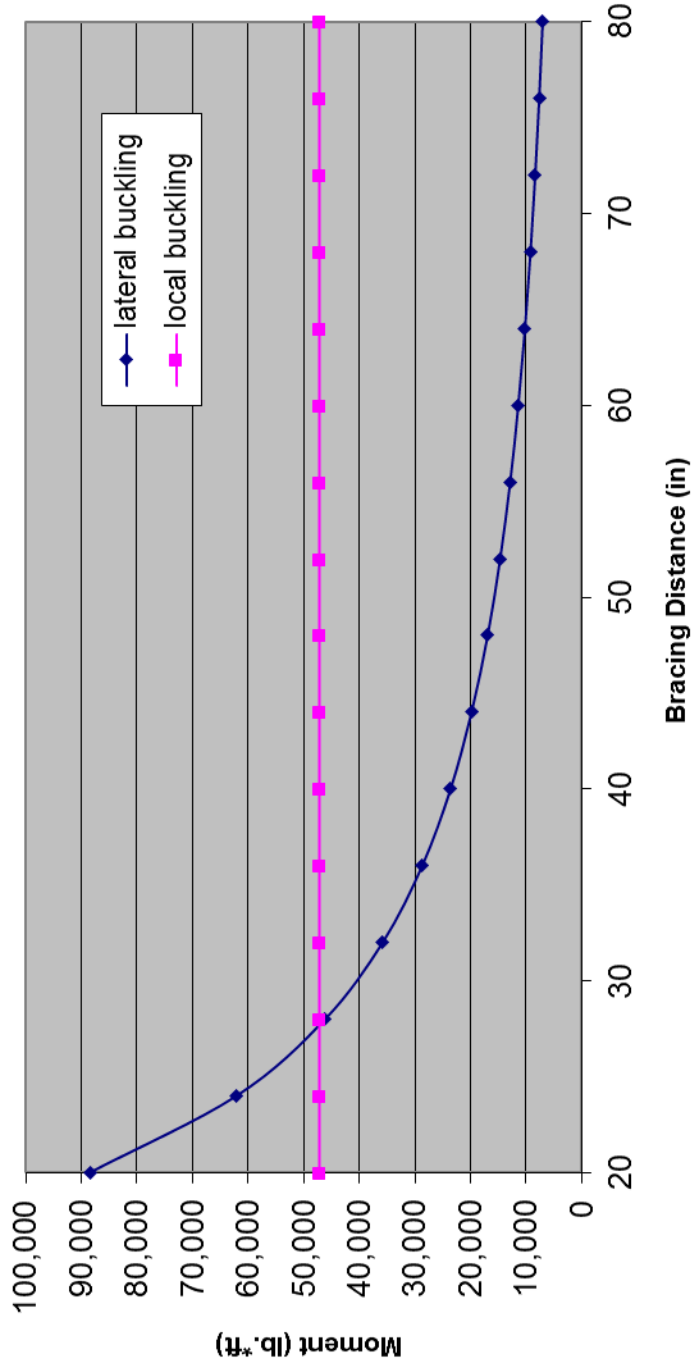

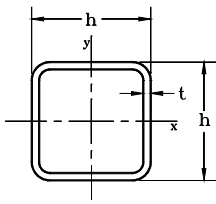

**PulTex Standard Structural Profiles
Square Tubes**

1-1/2" x 1-1/2" x 1/4" (Part # TQ 142) 1500/1525/1625 Series $E = 3.2 \times 10^6$ psi $G = 4.2 \times 10^5$ psi $I_x = .33$ in ⁴ $S_x = 44$ in ³ $A_w = .75$ in ² $Wt. = 1.02$ lbs/ft	Ultimate In-Plane Shear Strength 7,000 Ultimate Flexural Strength (psi) 33,000 Ultimate Local Buckling Strength 126,511	Simply Supported beam with Uniform Loads at various L/D ratios (lbs/ft)						
	Simply Supported with a Uniform Load							
Laterally Supported beams			L/D ratio					
Span (feet)	Allowable load, local compression buckling capacity, 2.5x Safety Factor (lbs/ft)	Allowable load, flexural capacity, 2.5x Safety Factor (lbs/ft)	Allowable load, In-plane shear of the web capacity, 3x Safety Factor (lbs/ft)	100	150	180	240	360
1	14844	3872	3500		3069	2557	1918	1279
2	3711	968	1750	667	444	370	278	185
3	1649	430	1167	204	136	113	85	57
4	928	242	875	87	58	48	36	24

Note: Bold numbers in the Factored Load Tables represent the governing load

1-3/4" x 1-3/4" x 1/8" (Part # TQ 126) 1500/1525/1625 Series $E = 3.2 \times 10^6$ psi $G = 4.2 \times 10^5$ psi $I_x = .35$ in ⁴ $S_x = .40$ in ³ $A_w = .438$ in ² $Wt. = .56$ lbs/ft	Ultimate In-Plane Shear Strength 7,000 Ultimate Flexural Strength (psi) 33,000 Ultimate Local Buckling Strength 23,237	Simply Supported beam with Uniform Loads at various L/D ratios (lbs/ft)						
	Simply Supported with a Uniform Load							
Laterally Supported beams			L/D ratio					
Span (feet)	Allowable load, local compression buckling capacity, 2.5x Safety Factor (lbs/ft)	Allowable load, flexural capacity, 2.5x Safety Factor (lbs/ft)	Allowable load, In-plane shear of the web capacity, 3x Safety Factor (lbs/ft)	100	150	180	240	360
1	2479	3520	2042				1770	1180
2	620	880	1021		452	377	282	188
3	275	391	681	212	141	118	88	59
4	155	220	510	91	61	51	38	25

Note: Bold numbers in the Factored Load Tables represent the governing load

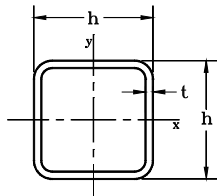

**PulTex Standard Structurals
Square Tubes**

1-3/4" x 1-3/4" x 1/4" (Part # TQ 144) 1500/1525/1625 Series E =3.2x10⁶ psi G =4.2x10⁵ psi I_x=.57 in⁴ S_x=.67 in³ A_w=.875 in Wt.=1.12 lbs/ft	Ultimate In-Plane Shear Strength (psi) 7,000 Ultimate Flexural Strength (psi) 33,000		Simply Supported beam with Uniform Loads at various L/D ratios (lbs/ft)					
	Ultimate Local Buckling Strength (psi) 92,947							
Simply Supported with a Uniform Load			L/D ratio					
Laterally Supported beams								
Span (feet)	Allowable load, local compression buckling capacity, 2.5x Safety Factor	Allowable load, flexural capacity, 2.5x Safety Factor (lbs/ft)	Allowable load, In-plane shear of the web capacity, 3x Safety	100	150	180	240	360
	1	16606	5896	4083			4061	3046
2	4152	1474	2042	1123	749	624	468	312
3	1845	655	1361	348	232	193	145	97
4	1038	369	1021	149	99	83	62	41
5	664	236	817	77	51	43	32	21

Note: Bold numbers in the Factored Load Tables represent the governing load

2" x 2" x 1/8" (Part # TQ 220) 1500/1525/1625 Series E =3.2x10⁶ psi G =4.2x10⁵ psi I_x=.53 in⁴ S_x=.53 in³ A_w=.5 in² Wt.=.73 lbs/ft	Ultimate In-Plane Shear Strength (psi) 7,000 Ultimate Flexural Strength (psi) 33,000		Simply Supported beam with Uniform Loads at various L/D ratios (lbs/ft)					
	Ultimate Local Buckling Strength (psi) 17,791							
Simply Supported with a Uniform Load			L/D ratio					
Laterally Supported beams								
Span (feet)	Allowable load, local compression buckling capacity, 2.5x Safety Factor (lbs/ft)	Allowable load, flexural capacity, 2.5x Safety Factor (lbs/ft)	Allowable load, In-plane shear of the web capacity, 3x Safety Factor (lbs/ft)	100	150	180	240	360
	1	2514	4664	2333				
2	629	1166	1167			554	415	277
3	279	518	778		211	176	132	88
4	157	292	583	137	91	76	57	38
5	101	187	467	71	47	39	30	20

Note: Bold numbers in the Factored Load Tables represent the governing load

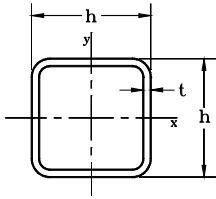

**PulTex Standard Structural Profiles
Square Tubes**

2" x 2" x 1/4" (Part # TQ 240) 1500/1525/1625 Series $E = 3.2 \times 10^6$ psi $G = 4.2 \times 10^5$ psi $I_x = .89$ in ⁴ $S_x = .89$ in ³ $A_w = 1.0$ in ² $Wt. = 1.50$ lbs/ft	Ultimate In-Plane Shear Strength (psi) 7,000 Ultimate Flexural Strength (psi) 33,000 Ultimate Local Buckling Strength (psi) 71,162	Simply Supported beam with Uniform Loads at various L/D ratios (lbs/ft)						
	Simply Supported with a Uniform Load Laterally Supported beams						L/D ratio	
Span (feet)	Allowable load, local compression buckling capacity, 2.5x Safety Factor (lbs/ft)	Allowable load, flexural capacity, 2.5x Safety Factor (lbs/ft)	Allowable load, In-plane shear of the web capacity, 3x Safety Factor (lbs/ft)	100	150	180	240	360
2	4222	1958	2333	1706	1137	948	711	474
3	1877	870	1556	536	357	298	223	149
4	1056	490	1167	231	154	128	96	64
5	676	313	933	119	80	66	50	33

Note: Bold numbers in the Factored Load Tables represent the governing load

2.11" x 2.11" x .20" (Part # TQ 230) 1500/1525/1625 Series $E = 3.2 \times 10^6$ psi $G = 4.2 \times 10^5$ psi $I_x = .91$ in ⁴ $S_x = .86$ in ³ $A_w = .84$ in ² $Wt. = 1.23$ lbs/ft	Ultimate In-Plane Shear Strength (psi) 7,000 Ultimate Flexural Strength (psi) 33,000 Ultimate Local Buckling Strength (psi) 40,919	Simply Supported beam with Uniform Loads at various L/D ratios (lbs/ft)						
	Simply Supported with a Uniform Load Laterally Supported beams						L/D ratio	
Span (feet)	Allowable load, local compression buckling capacity, 2.5x Safety Factor (lbs/ft)	Allowable load, flexural capacity, 2.5x Safety Factor (lbs/ft)	Allowable load, In-plane shear of the web capacity, 3x Safety Factor (lbs/ft)	100	150	180	240	360
2	2346	1892	1969	1708	1138	949	711	474
3	1043	841	1313	542	361	301	226	151
4	587	473	985	235	156	130	98	65
5	375	303	788	122	81	68	51	34
6	261	210	656	71	47	39	30	20

Note: Bold numbers in the Factored Load Tables represent the governing load

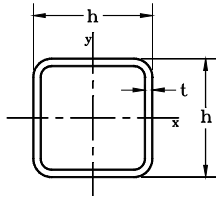

**PulTex Standard Structural Profiles
Square Tubes**

2-1/2" x 2-1/2" x 1/4" (Part # TQ 242) 1500/1525/1625 Series	Ultimate In-Plane Shear Strength (psi)		7,000	Simply Supported beam with Uniform Loads at various L/D ratios (lbs/ft)					
	Ultimate Flexural Strength (psi)		33,000						
E =3.2x10 ⁶ psi I _x = 1.90 in ⁴ A _w =1.25 in ²	G =4.2x10 ⁵ psi S _x = 1.52 in ³ Wt.=1.87 lbs/ft	Ultimate Local Buckling Strength (psi)		45,544	Simply Supported with a Uniform Load				
		Simply Supported with a Uniform Load							
Laterally Supported beams				L/D ratio					
Span (feet)	Allowable load, local compression buckling capacity, 2.5x Safety Factor (lbs/ft)	Allowable load, flexural capacity, 2.5x Safety Factor (lbs/ft)	Allowable load, In-plane shear of the web capacity, 3x Safety Factor (lbs/ft)	100	150	180	240	360	
2	4615	3344	2917	3398	2265	1888	1416	944	
3	2051	1486	1944	1106	737	615	461	307	
4	1154	836	1458	483	322	269	201	134	
5	738	535	1167	252	168	140	105	70	
6	513	372	972	147	98	82	61	41	
7	377	273	833	93	62	52	39	26	

Note: Bold numbers in the Factored Load Tables represent the governing load

2.47" x 2.47" x 0.220" (Part # TQ 247) 1500/1525/1625 Series	Ultimate In-Plane Shear Strength (psi)		7,000	Simply Supported beam with Uniform Loads at various L/D ratios (lbs/ft)					
	Ultimate Flexural Strength (psi)		33,000						
E =3.2x10 ⁶ psi I _x = 1.67 in ⁴ A _w =1.09 in ²	G =4.2x10 ⁵ psi S _x = 1.35 in ³ Wt.=1.53 lbs/ft	Ultimate Local Buckling Strength (psi)		36,131	Simply Supported with a Uniform Load				
		Simply Supported with a Uniform Load							
Laterally Supported beams				L/D ratio					
Span (feet)	Allowable load, local compression buckling capacity, 2.5x Safety Factor (lbs/ft)	Allowable load, flexural capacity, 2.5x Safety Factor (lbs/ft)	Allowable load, In-plane shear of the web capacity, 3x Safety Factor (lbs/ft)	100	150	180	240	360	
2	3257	2974	2536	2981	1987	1656	1242	828	
3	1447	1322	1691	971	648	540	405	270	
4	814	744	1268	425	283	236	177	118	
5	521	476	1014	221	147	123	92	61	
6	362	330	845	129	86	72	54	36	
7	266	243	725	82	55	45	34	23	
8	204	186	634	55	37	31	23	15	
9	161	147	564	39	26	22	16	11	

Note: Bold numbers in the Factored Load Tables represent the governing load

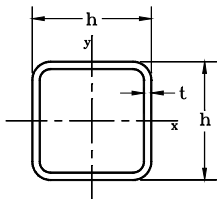

**PulTex Standard Structural Profiles
Square Tubes**

3" x 3" x 1/4" (Part # TQ 340) 1500/1525/1625 Series		Ultimate In-Plane Shear Strength (psi)	7,000	Simply Supported beam with Uniform Loads at various L/D ratios (lbs/ft)					
		Ultimate Flexural Strength (psi)	33,000						
E = 3.2x10 ⁶ psi	G = 4.2x10 ⁵ psi	Ultimate Local Buckling Strength (psi)	31,628						
I _x = 3.47 in ⁴	S _x = 2.31 in ³	Simply Supported with a Uniform Load			L/D ratio				
A _w = 1.5 in ²	Wt. = 2.22 lbs/ft	Laterally Supported beams			L/D ratio				
Span (feet)	Allowable load, local compression buckling capacity, 2.5x Safety Factor (lbs/ft)	Allowable load, flexural capacity, 2.5x Safety Factor (lbs/ft)	Allowable load, In-plane shear of the web capacity, 3x Safety Factor (lbs/ft)	L/D ratio					
				100	150	180	240	360	
2	4871	5082	3500			3179	2384	1589	
3	2165	2259	2333	1940	1293	1078	808	539	
4	1218	1271	1750	862	575	479	359	239	
5	779	813	1400	453	302	251	189	126	
6	541	565	1167	266	177	148	111	74	
7	398	415	1000	169	112	94	70	47	
8	304	318	875	114	76	63	47	32	

Note: Bold numbers in the Factored Load Tables represent the governing load

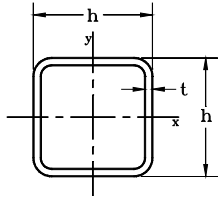

**PulTex Standard Structural Profiles
Square Tubes**

3-1/2" x 3-1/2" x 3/8" (Part # TQ 360) 1500/1525/1625 Series	Ultimate In-Plane Shear Strength (psi) 7,000		Simply Supported beam with Uniform Loads at various L/D ratios (lbs/ft)					
	Ultimate Flexural Strength (psi) 33,000							
E =3.2x10 ⁶ psi G =4.2x10 ⁵ psi I _x = 7.71 in ⁴ S _x = 4.40 in ³ A _w =2.62 in ² Wt.=3.84 lbs/ft	Ultimate Local Buckling Strength (psi) 52,283		Simply Supported with a Uniform Load					
	Simply Supported beams							
Laterally Supported beams			L/D ratio					
Span (feet)	Allowable load, local compression buckling capacity, 2.5x Safety Factor (lbs/ft)	Allowable load, flexural capacity, 2.5x Safety Factor (lbs/ft)	Allowable load, In-plane shear of the web capacity, 3x Safety Factor (lbs/ft)	L/D ratio				
				100	150	180	240	360
2	15347	9687	6125				4990	3326
3	6821	4305	4083	4179	2786	2321	1741	1161
4	3837	2422	3063	1880	1253	1044	783	522
5	2455	1550	2450	993	662	552	414	276
6	1705	1076	2042	585	390	325	244	162
7	1253	791	1750	372	248	207	155	103
8	959	605	1531	251	167	139	105	70
9	758	478	1361	177	118	98	74	49
10	614	387	1225	130	86	72	54	36
11	507	320	1114	98	65	54	41	27
12	426	269	1021	75	50	42	31	21
13	363	229	942	59	40	33	25	16
14	313	198	875	48	32	26	20	13
15	273	172	817	39	26	22	16	11
16	240	151	766	32	21	18	13	9
17	212	134	721	27	18	15	11	7
18	189	120	681	22	15	12	9	6
19	170	107	645	19	13	11	8	5
20	153	97	613	16	11	9	7	5

Note: Bold numbers in the Factored Load Tables represent the governing load

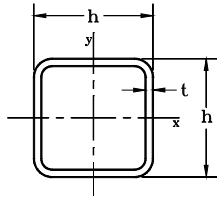

**PulTex Standard Structural Profiles
Square Tubes**

4" x 4" x 1/4" (Part # TQ 440) 1500/1525/1625 Series		Ultimate In-Plane Shear Strength (psi)	7,000	Simply Supported beam with Uniform Loads at various L/D ratios (lbs/ft)					
E =3.2x10 ⁶ psi G =4.2x10 ⁵ psi		Ultimate Flexural Strength (psi)	33,000						
I _x = 8.75 in ⁴	S _x = 4.37 in ³	Ultimate Local Buckling Strength (psi)	17,791						
A _w =2.0 in ² Wt.=3.10 lbs/ft		Simply Supported with a Uniform Load			L/D ratio				
		Laterally Supported beams							
Span (feet)	Allowable load, local compression buckling capacity, 2.5x Safety Factor (lbs/ft)	Allowable load, flexural capacity, 2.5x Safety Factor (lbs/ft)	Allowable load, In-plane shear of the web capacity, 3x Safety Factor (lbs/ft)	L/D ratio					
				100	150	180	240	360	
3	2304	4273	3111				1848	1232	
4	1296	2404	2333			1138	854	569	
5	829	1538	1867			610	457	305	
6	576	1068	1556		434	362	271	181	
7	423	785	1333	416	278	231	174	116	
8	324	601	1167	282	188	157	117	78	
9	256	475	1037	199	133	111	83	55	
10	207	385	933	146	97	81	61	41	
11	171	318	848	110	73	61	46	31	
12	144	267	778	85	57	47	35	24	

Note: Bold numbers in the Factored Load Tables represent the governing load

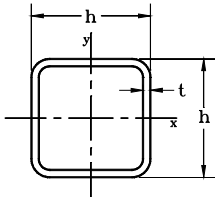

**PulTex Standard Structural Profiles
Square Tubes**

6" x 6" x 3/8" (Part # TQ 660) 1500/1525/1625 Series		Ultimate In-Plane Shear Strength (psi)	7,000	Simply Supported beam with Uniform Loads at various L/D ratios (lbs/ft)					
E = 3.2x10 ⁶ psi G = 4.2x10 ⁵ psi		Ultimate Flexural Strength (psi)	33,000	Simply Supported with a Uniform Load					
I _x = 44.93 in ⁴ S _x = 14.98 in ³		Ultimate Local Buckling Strength	17,791						
A _w = 4.5 in ² Wt. = 7.58 lbs/ft		Laterally Supported beams			L/D ratio				
Span (feet)	Allowable load, local compression buckling capacity, 2.5x Safety Factor (lbs/ft)	Allowable load, flexural capacity, 2.5x Safety Factor (lbs/ft)	Allowable load, In-plane shear of the web capacity, 3x Safety Factor (lbs/ft)	L/D ratio					
				100	150	180	240	360	
3	7896	14647	7000					5046	
4	4442	8239	5250				3791	2527	
5	2843	5273	4200			2833	2125	1417	
6	1974	3662	3500			1729	1297	864	
7	1450	2690	3000		1351	1126	844	563	
8	1110	2060	2625		925	771	578	385	
9	877	1627	2333		660	550	412	275	
10	711	1318	2100		487	405	304	203	
11	587	1089	1909	553	369	307	230	154	
12	494	915	1750	429	286	238	179	119	
13	421	780	1615	339	226	188	141	94	
14	363	673	1500	272	182	151	114	76	
15	316	586	1400	222	148	123	93	62	
16	278	515	1313	184	122	102	76	51	
17	246	456	1235	153	102	85	64	43	
18	219	407	1167	129	86	72	54	36	
19	197	365	1105	110	73	61	46	31	
20	178	330	1050	95	63	53	39	26	

Note: Bold numbers in the Factored Load Tables represent the governing load

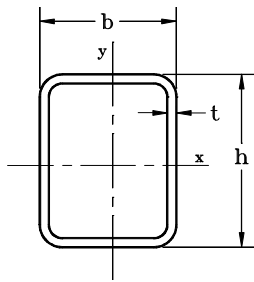

**PulTex Standard Structural Profiles
Rectangular Tubes**

4.40" x 1.43" x 0.13" (Part # TR 420) 1500/1525/1625 Series		Ultimate In-Plane Shear Strength (psi)	7,000	Simply Supported beam with Uniform Loads at various L/D ratios (lbs/ft)					
		Ultimate Flexural Strength (psi)	33,000						
E =3.2x10 ⁶ psi	G =4.2x10 ⁵ psi	Ultimate Local Buckling Strength (psi)	37,249	Simply Supported with a Uniform Load					
I _x =2.89 in ⁴	S _x =1.31 in ³	Simply Supported with a Uniform Load							
A _w =1.14 in ²	Wt.=1.10 lbs/ft	Laterally Supported beams			L/D ratio				
Span (feet)	Allowable load, local compression buckling capacity, 2.5x Safety Factor (lbs/ft)	Allowable load, flexural capacity, 2.5x Safety Factor (lbs/ft)	Allowable load, In-plane shear of the web capacity, 3x Safety Factor (lbs/ft)	100	150	180	240	360	
2	3253	2882	2669			2593	1945	1297	
3	1446	1281	1780		1066	888	666	444	
4	813	721	1335	713	476	396	297	198	
5	520	461	1068	375	250	209	156	104	
6	361	320	890	220	147	122	92	61	
7	266	235	763	140	93	78	58	39	

Note: Bold numbers in the Factored Load Tables represent the governing load

4.74" x 1.72" x 0.125" (Part # TR 422) 1500/1525/1625 Series		Ultimate In-Plane Shear Strength (psi)	7,000	Simply Supported beam with Uniform Loads at various L/D ratios (lbs/ft)					
		Ultimate Flexural Strength (psi)	33,000						
E =3.2x10 ⁶	G =4.2x10 ⁵ psi	Ultimate Local Buckling Strength (psi)	23,824	Simply Supported with a Uniform Load					
I _x =4.20 in ⁴	S _x =1.77 in ³	Simply Supported with a Uniform Load							
A _w =1.18 in ²	Wt.=1.36 lbs/ft	Laterally Supported beams			L/D ratio				
Span (feet)	Allowable load, local compression buckling capacity, 2.5x Safety Factor (lbs/ft)	Allowable load, flexural capacity, 2.5x Safety Factor (lbs/ft)	Allowable load, In-plane shear of the web capacity, 3x Safety Factor (lbs/ft)	100	150	180	240	360	
3	1249	1731	1843			1229	922	615	
4	703	974	1383		671	559	419	280	
5	450	623	1106		357	297	223	149	
6	312	433	922		211	176	132	88	
7	229	318	790	202	134	112	84	56	
8	176	243	691	136	91	76	57	38	

Note: Bold numbers in the Factored Load Tables represent the governing load

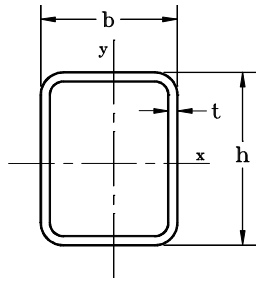

**PulTex Standard Structural Profiles
Rectangular Tubes**

5.07" x 2" x 0.132" (Part # TR 522) 1500/1525/1625 Series E =3.2x10 ⁶ psi G =4.2x10 ⁵ psi I _x =5.65 in ⁴ S _x =2.23 in ³ A _w =1.34 in ² Wt.=1.53 lbs/ft	Ultimate In-Plane Shear Strength (psi)	7,000	Simply Supported beam with Uniform Loads at various L/D ratios (lbs/ft)					
	Ultimate Flexural Strength (psi)	33,000						
	Ultimate Local Buckling Strength (psi)	19,663						
	Simply Supported with a Uniform Load			L/D ratio				
Laterally Supported beams								
Span (feet)	Allowable load, local compression buckling capacity, 2.5x Safety Factor (lbs/ft)	Allowable load, flexural capacity, 2.5x Safety Factor (lbs/ft)	Allowable load, In-plane shear of the web capacity, 3x Safety Factor (lbs/ft)	100	150	180	240	360
3	1299	2180	2082				1202	801
4	731	1227	1562				554	369
5	468	785	1249			395	296	197
6	325	545	1041		281	234	176	117
7	239	400	892		180	150	112	75
8	183	307	781	182	121	101	76	51
9	144	242	694	129	86	72	54	36

Note: Bold numbers in the Factored Load Tables represent the governing load

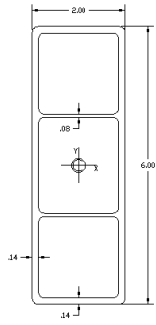

PulTex Standard Structural Profiles Rectangular Tubes

6" x 2" x 0.135" Multicell (Part # TR 620) 1500/1525/1625 Series		Ultimate In-Plane Shear Strength (psi)	7,000	Simply Supported beam with Uniform Loads at various L/D ratios (lbs/ft)					
E = 3.2x10 ⁶ G = 4.2x10 ⁵ psi		Ultimate Flexural Strength (psi)	33,000						
I _x = 9.34 in ⁴ S _x = 3.11 in ³		Simply Supported with a Uniform Load			L/D ratio				
A _w = 1.62 in ² Wt. = 1.92 lbs/ft		Laterally Supported beams							
Span (feet)	Allowable load, local compression buckling capacity, 2.5x Safety Factor (lbs/ft)	Allowable load, flexural capacity, 2.5x Safety Factor (lbs/ft)	Allowable load, In-plane shear of the web capacity, 3x Safety Factor (lbs/ft)						
				100	150	180	240	360	
4	1065	1711	1890				877	585	
5	681	1095	1512			634	476	317	
6	473	760	1260		455	379	284	190	
7	348	559	1080		292	244	183	122	
8	266	428	945		198	165	124	83	
9	210	338	840		141	117	88	59	
10	170	274	756	155	103	86	65	43	
11	141	226	687	117	78	65	49	32	

Note: Bold numbers in the Factored Load Tables represent the governing load

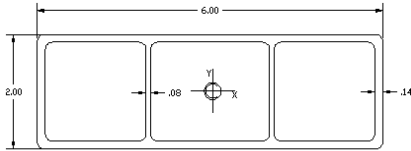

**PulTex Standard Structural Profiles
Rectangular Tubes**

2" x 6" x 0.135" Multicell (Part # TR 620) 1500/1525/1625 Series E =3.2x10⁶ psi G =4.2x10⁵ psi I_x=1.61 in⁴ S_x=1.61 in³ A_w=.88 in² Wt.=1.92 lbs/ft	Ultimate In-Plane Shear Strength (psi) 7,000 Ultimate Flexural Strength (psi) 33,000		Simply Supported beam with Uniform Loads at various L/D ratios (lbs/ft)					
	Ultimate Local Buckling Strength (psi) 20,751 Simply Supported with a Uniform Load							
	Laterally Supported beams			L/D ratio				
Span (feet)	Allowable load, local compression buckling capacity, 2.5x Safety Factor (lbs/ft)	Allowable load, flexural capacity, 2.5x Safety Factor (lbs/ft)	Allowable load, In-plane shear of the web capacity, 3x Safety Factor (lbs/ft)	100	150	180	240	360
4	557	886	1027	406	271	225	169	113
5	356	567	821	212	141	118	88	59
6	247	394	684	124	83	69	52	34
7	182	289	587	79	52	44	33	22

Note: Bold numbers in the Factored Load Tables represent the governing load

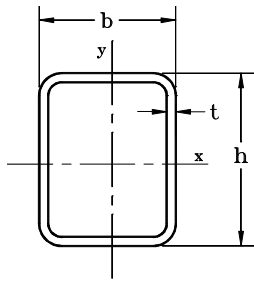

**PulTex Standard Structural Profiles
Rectangular Tubes**

6" x 4" x 1/4" (Part # TR 640) 1500/1525/1625 Series E =3.2x10 ⁶ psi G =4.2x10 ⁵ psi I _x =22.31 in ⁴ S _x =7.44 in ³ A _w =3.0 in ² Wt.=3.87 lbs/ft	Ultimate In-Plane Shear Strength (psi) 7,000		Simply Supported beam with Uniform Loads at various L/D ratios (lbs/ft)					
	Ultimate Flexural Strength (psi) 33,000							
	Ultimate Local Buckling Strength (psi) 17,753		Simply Supported with a Uniform Load					
	Laterally Supported beams							L/D ratio
Span (feet)	Allowable load, local compression buckling capacity, 2.5x Safety Factor (lbs/ft)	Allowable load, flexural capacity, 2.5x Safety Factor (lbs/ft)	Allowable load, In-plane shear of the web capacity, 3x Safety Factor (lbs/ft)	100	150	180	240	360
4	2201	4092	3500				2005	1337
5	1409	2619	2800				1103	735
6	978	1819	2333			886	665	443
7	719	1336	2000		687	573	429	286
8	550	1023	1750		468	390	293	195
9	435	808	1556		333	277	208	139
10	352	655	1400		245	204	153	102
11	291	541	1273	277	185	154	116	77
12	245	455	1167	215	143	119	89	60
13	208	387	1077	170	113	94	71	47
14	180	334	1000	136	91	76	57	38
15	157	291	933	111	74	62	46	31

Note: Bold numbers in the Factored Load Tables represent the governing load

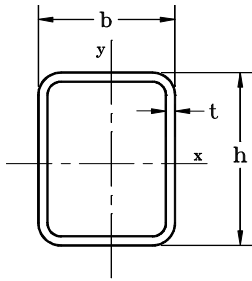

**PulTex Standard Structural Profiles
Rectangular Tubes**

7" x 4" x 1/4" (Part # TR 740) 1500/1525/1625 Series E =3.2x10 ⁶ psi G =4.2x10 ⁵ psi I _x =33.61 in ⁴ S _x =9.61 in ³ A _w =3.5 in ² Wt.=4.09 lbs/ft	Ultimate In-Plane Shear Strength (psi)	7,000	Simply Supported beam with Uniform Loads at various L/D ratios (lbs/ft)						
	Ultimate Flexural Strength (psi)	33,000							
	Ultimate Local Buckling Strength (psi)	17,702	Simply Supported with a Uniform Load			L/D ratio			
Laterally Supported beams									
Span (feet)	Allowable load, local compression buckling capacity, 2.5x Safety Factor (lbs/ft)	Allowable load, flexural capacity, 2.5x Safety Factor (lbs/ft)	Allowable load, In-plane shear of the web capacity, 3x Safety Factor (lbs/ft)	100	150	180	240	360	
4	2835	5286	4083					1908	
5	1815	3383	3267				1600	1067	
6	1260	2349	2722				974	650	
7	926	1726	2333			845	634	422	
8	709	1321	2042		694	578	434	289	
9	560	1044	1815		495	412	309	206	
10	454	846	1633		365	304	228	152	
11	375	699	1485		276	230	173	115	
12	315	587	1361		214	178	134	89	
13	268	500	1256	254	169	141	106	70	
14	231	431	1167	204	136	113	85	57	
15	202	376	1089	166	111	92	69	46	
16	177	330	1021	137	92	76	57	38	
17	157	293	961	115	77	64	48	32	

Note: Bold numbers in the Factored Load Tables represent the governing load

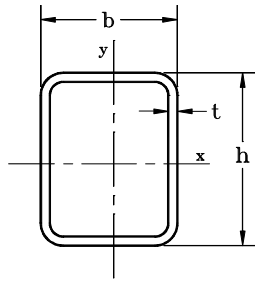

**PulTex Standard Structural Profiles
Rectangular Tubes**

7" x 4" x 3/8" (Part # TR 760) 1500/1525/1625 Series		Ultimate In-Plane Shear Strength (psi)	7,000	Simply Supported beam with Uniform Loads at various L/D ratios (lbs/ft)					
		Ultimate Flexural Strength (psi)	33,000						
E =3.2x10 ⁶ psi G =4.2x10 ⁵ psi		Ultimate Local Buckling Strength (psi)	39,830	Simply Supported with a Uniform Load					
I _x =47.58 in ⁴ S _x =13.60 in ³									
A _w =5.25 in ² Wt.=6.21 lbs/ft		Laterally Supported beams			L/D ratio				
Span (feet)	Allowable load, local compression buckling capacity, 2.5x Safety Factor (lbs/ft)	Allowable load, flexural capacity, 2.5x Safety Factor (lbs/ft)	Allowable load, In-plane shear of the web capacity, 3x Safety Factor (lbs/ft)						
				100	150	180	240	360	
4	9028	7480	6125			5474	4105	2737	
5	5778	4787	4900		3657	3048	2286	1524	
6	4012	3324	4083		2222	1852	1389	926	
7	2948	2442	3500	2164	1443	1202	902	601	
8	2257	1870	3063	1480	986	822	616	411	
9	1783	1478	2722	1054	703	586	439	293	
10	1444	1197	2450	776	518	431	323	216	
11	1194	989	2227	588	392	327	245	163	
12	1003	831	2042	455	304	253	190	126	
13	855	708	1885	360	240	200	150	100	
14	737	611	1750	289	193	161	120	80	
15	642	532	1633	236	157	131	98	65	
16	564	468	1531	195	130	108	81	54	
17	500	414	1441	163	108	90	68	45	
18	446	369	1361	137	92	76	57	38	

Note: Bold numbers in the Factored Load Tables represent the governing load

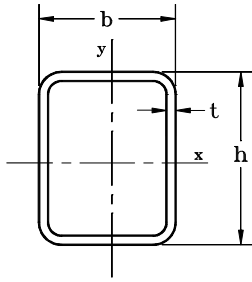

**PulTex Standard Structural Profiles
Rectangular Tubes**

8" x 4" x 1/4" (Part # TR 842) 1500/1525/1625 Series		Ultimate In-Plane Shear Strength (psi)	7,000	Simply Supported beam with Uniform Loads at various L/D ratios (lbs/ft)					
E = 3.2x10 ⁶ psi G = 4.2x10 ⁵ psi		Ultimate Flexural Strength (psi)	33,000						
I _x = 46.80 in ⁴ S _x = 11.70 in ³		Ultimate Local Buckling Strength (psi)	17,673	Simply Supported with a Uniform Load					
A _w = 4.0 in ² Wt. = 4.70 lbs/ft		Laterally Supported beams							L/D ratio
Span (feet)	Allowable load, local compression buckling capacity, 2.5x Safety Factor (lbs/ft)	Allowable load, flexural capacity, 2.5x Safety Factor (lbs/ft)	Allowable load, In-plane shear of the web capacity, 3x Safety Factor (lbs/ft)	100	150	180	240	360	
				5	2206	4118	3733		
6	1532	2860	3111				1322	882	
7	1125	2101	2667				865	577	
8	862	1609	2333			793	595	397	
9	681	1271	2074		680	567	425	284	
10	551	1030	1867		503	419	314	209	
11	456	851	1697		381	318	238	159	
12	383	715	1556		296	247	185	123	
13	326	609	1436		234	195	146	98	
14	281	525	1333		188	157	118	78	
15	245	458	1244	231	154	128	96	64	
16	215	402	1167	191	127	106	79	53	
17	191	356	1098	159	106	88	66	44	
18	170	318	1037	134	90	75	56	37	
19	153	285	982	115	76	64	48	32	

Note: Bold numbers in the Factored Load Tables represent the governing load

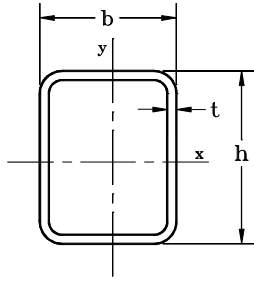

**PulTex Standard Structural Profiles
Rectangular Tubes**

8" x 4" x 3/8" (Part # TR 860) 1500/1525/1625 Series E =3.2x10 ⁶ psi G =4.2x10 ⁵ psi I _x =66.63 in ⁴ S _x =16.66 in ³ A _w =6.0 in ² Wt.=6.71 lbs/ft	Ultimate In-Plane Shear Strength (psi) 7,000 Ultimate Flexural Strength (psi) 33,000 Ultimate Local Buckling Strength (psi) 39,764		Simply Supported beam with Uniform Loads at various L/D ratios (lbs/ft)					
	Simply Supported with a Uniform Load							
	Laterally Supported beams			L/D ratio				
Span (feet)	Allowable load, local compression buckling capacity, 2.5x Safety Factor (lbs/ft)	Allowable load, flexural capacity, 2.5x Safety Factor (lbs/ft)	Allowable load, In-plane shear of the web capacity, 3x Safety Factor (lbs/ft)	100	150	180	240	360
5	7066	5864	5600		4948	4124	3093	2062
6	4907	4072	4667		3034	2529	1896	1264
7	3605	2992	4000	2973	1982	1652	1239	826
8	2760	2291	3500	2041	1361	1134	850	567
9	2181	1810	3111	1458	972	810	608	405
10	1767	1466	2800	1076	718	598	449	299
11	1460	1212	2545	816	544	454	340	227
12	1227	1018	2333	633	422	352	264	176
13	1045	868	2154	501	334	278	209	139
14	901	748	2000	403	269	224	168	112
15	785	652	1867	329	219	183	137	91
16	690	573	1750	272	181	151	113	75
17	611	507	1647	227	151	126	95	63
18	545	452	1556	192	128	106	80	53
19	489	406	1474	163	109	91	68	45
20	442	367	1400	140	93	78	58	39

Note: Bold numbers in the Factored Load Tables represent the governing load

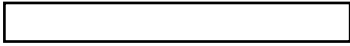

**PulTex Standard Structural Profiles
Flat Sheets**

1/8" (Part # FS 020) PulTex 1500/1525 & 1625 Series	E = 2.0x 10 ⁶ psi					Weight = 1.18 lb/ft ²
	All Allowable Uniform Loads are in lbs./ft ² . Sheet Spanning in Lengthwise Direction					
span (inches)	L/D					
	100	150	180	240	360	
12	21	14	12	9	6	
18	6	4	3	3	2	
24	3	2	1.4	1.1	0.7	
1/8" (Part # FS020) PulTex 1500/1525 & 1625 Series	E = .8x 10 ⁶ psi					Weight = 1.18 lb/ft ²
	All Allowable Uniform Loads are in lbs./ft ² . Sheet Spanning in Crosswise Direction					
span (inches)	L/D					
	100	150	180	240	360	
12	8	6	5	3	2	
18	2	2	1.37	1.03	0.69	
24	1.0	0.7	0.58	0.43	0.29	

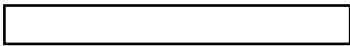

**PulTex Standard Structural Profiles
Flat Sheets**

1/4" (Part # FS 040) PulTex 1500/1525 & 1625 Series	E = 2.0x 10 ⁶ psi					Weight = 2.30 lb/ft ²
	All Allowable Uniform Loads are in lbs./ft ² . Sheet Spanning in Lengthwise Direction					
span (inches)	L/D					
	100	150	180	240	360	
12	167	111	93	69	46	
18	49	33	27	21	14	
24	21	14	12	9	6	
1/4" (Part # FS 040) PulTex 1500/1525 & 1625 Series	E = .8x 10 ⁶ psi					Weight = 2.30 lb/ft ²
	All Allowable Uniform Loads are in lbs./ft ² . Sheet Spanning in Crosswise Direction					
span (inches)	L/D					
	100	150	180	240	360	
12	67	44	37	28	19	
18	20	13	11	8	5	
24	8	6	5	3	2	



**PulTex Standard Structural Profiles
Flat Sheets**

3/8" (Part # FS 060) PulTex 1500/1525 & 1625 Series	E = 2.0x 10 ⁶ psi					Weight = 3.47 lb/ft ²
	All Allowable Uniform Loads are in lbs./ft ² .					
	Sheet Spanning in Lengthwise Direction					
span (inches)	L/D					
	100	150	180	240	360	
12	563	375	313	234	156	
18	167	111	93	69	46	
24	70	47	39	29	20	
30	36	24	20	15	10	
36	21	14	12	9	6	
3/8" (Part # FS 060) PulTex 1500/1525 & 1625 Series	E = .8x 10 ⁶ psi					Weight = 3.47 lb/ft ²
	All Allowable Uniform Loads are in lbs./ft ² .					
	Sheet Spanning in Crosswise Direction					
span (inches)	L/D					
	100	150	180	240	360	
12	225	150	125	94	63	
18	67	44	37	28	19	
24	28	19	16	12	8	
30	14	10	8	6	4	
36	8	6	5	3	2	



**PulTex Standard Structural Profiles
Flat Sheets**

span (inches)	E = 2.0x 10⁶ psi Weight = 4.77 lb/ft² All Allowable Uniform Loads are in lbs./ft². Sheet Spanning in Lengthwise Direction				
	L/D				
	100	150	180	240	360
12	1333	889	741	556	370
18	395	263	219	165	110
24	167	111	93	69	46
30	85	57	47	36	24
36	49	33	27	21	14
42	31	21	17	13	9
48	21	14	12	9	6

span (inches)	E = .8x 10⁶ psi Weight = 4.77 lb/ft² All Allowable Uniform Loads are in lbs./ft². Sheet Spanning in Crosswise Direction				
	L/D				
	100	150	180	240	360
12	533	356	296	222	148
18	158	105	88	66	44
24	67	44	37	28	19
30	34	23	19	14	9
36	20	13	11	8	5
42	12	8	7	5	3
48	8	6	5	3	2



**PulTex Standard Structural Profiles
Flat Sheets**

span (inches)	L/D				
	100	150	180	240	360
12	2604	1736	1447	1085	723
18	772	514	429	322	214
24	326	217	181	136	90
30	167	111	93	69	46
36	96	64	54	40	27
42	61	40	34	25	17
48	41	27	23	17	11
54	29	19	16	12	8
60	21	14	12	9	6

span (inches)	L/D				
	100	150	180	240	360
12	1042	694	579	434	289
18	309	206	171	129	86
24	130	87	72	54	36
30	67	44	37	28	19
36	39	26	21	16	11
42	24	16	13	10	7
48	16	11	9	7	5
54	11	8	6	5	3
60	8	6	5	3	2



**PulTex Standard Structural Profiles
Flat Sheets**

span (inches)	L/D				
	100	150	180	240	360
12	4500	3000	2500	1875	1250
18	1333	889	741	556	370
24	563	375	313	234	156
30	288	192	160	120	80
36	167	111	93	69	46
42	105	70	58	44	29
48	70	47	39	29	20
54	49	33	27	21	14
60	36	24	20	15	10

span (inches)	L/D				
	100	150	180	240	360
12	1800	1200	1000	750	500
18	533	356	296	222	148
24	225	150	125	94	63
30	115	77	64	48	32
36	67	44	37	28	19
42	42	28	23	17	12
48	28	19	16	12	8
54	20	13	11	8	5
60	14	10	8	6	4



**PulTex Standard Structural Profiles
Flat Sheets**

span (inches)	L/D				
	100	150	180	240	360
12	10667	7111	5926	4444	2963
18	3160	2107	1756	1317	878
24	1333	889	741	556	370
30	683	455	379	284	190
36	395	263	219	165	110
42	249	166	138	104	69
48	167	111	93	69	46
54	117	78	65	49	33
60	85	57	47	36	24

span (inches)	L/D				
	100	150	180	240	360
12	4267	2844	2370	1778	1185
18	1264	843	702	527	351
24	533	356	296	222	148
30	273	182	152	114	76
36	158	105	88	66	44
42	100	66	55	41	28
48	67	44	37	28	19
54	47	31	26	20	13
60	34	23	19	14	9

Clip Connection Load Tables with PulTex **SuperStructural** Angles

The following Clip Connection Load Tables were developed based on full section testing of the PulTex **SuperStructural** angles. The experimental procedure can be located in Appendix A. The load tables were developed based on the following:

1. Experimental test results
2. Room temperature (73°)
3. A safety factor has **not** been applied. All loads are ultimate unless noted.
4. An ultimate bearing strength of 33,000 psi
5. A 4% hole deformation bearing stress of 12,000 psi
6. No damage to the composite materials
7. No chemical exposure
8. Bolted connection only; no adhesive.
9. Full section shear strength through angle heel = 3,400 psi (1500/1525 Series); 3,900 psi (1625 Series)

Note: Clip angle connection dimensions are governed by internal dimensions of beams and external dimensions of the flanges on the columns.

1500/1525 Series PulTex SuperStructural Angles												
Clip Angle Thickness (in)	Angle Connection Length (in)	Bolt Hole Dia. (in)	Bolt Dia. (in)	# of Angles in Connection	# of Bolts in Shear	# of Bolts through Beam Web	# of Bolts Connected to Column	Ultimate Shear Load through Angle Heels (lbs.)	Ultimate Bearing Load of Connection (lbs.)	Allowable Bearing Load for 4% Hole Deformation (lbs.)	Clip Angle Ultimate Load before Failure (lbs.)	
3/8	4 1/2	9/16	1/2	2	4	2	4	11,475	24,750	9,000	11,475	
3/8	4 1/2	11/16	5/8	2	4	2	4	11,475	30,938	11,250	11,475	
1/2	4 1/2	9/16	1/2	2	4	2	4	15,300	33,000	12,000	15,300	
1/2	4 1/2	11/16	5/8	2	4	2	4	15,300	41,250	15,000	15,300	

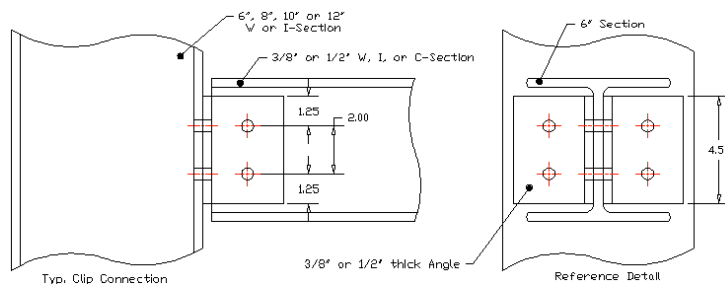

1500/1525 Series PulTex SuperStructural Angles												
Clip Angle Thickness (in)	Angle Connection Length (in)	Bolt Hole Dia. (in)	Bolt Dia. (in)	# of Angles in Connection	# of Bolts in Shear	# of Bolts through Beam Web	# of Bolts Connected to Column	Ultimate Shear Load through Angle Heels (lbs.)	Ultimate Bearing Load of Connection (lbs.)	Allowable Bearing Load for 4% Hole Deformation (lbs.)	Clip Angle Ultimate Load before Failure (lbs.)	
3/8	6	9/16	1/2	2	4	2	4	15,300	24,750	9,000	15,300	
3/8	6	11/16	5/8	2	4	2	4	15,300	30,938	11,250	15,300	
1/2	6	9/16	1/2	2	4	2	4	20,400	33,000	12,000	20,400	
1/2	6	11/16	5/8	2	4	2	4	20,400	41,250	15,000	20,400	

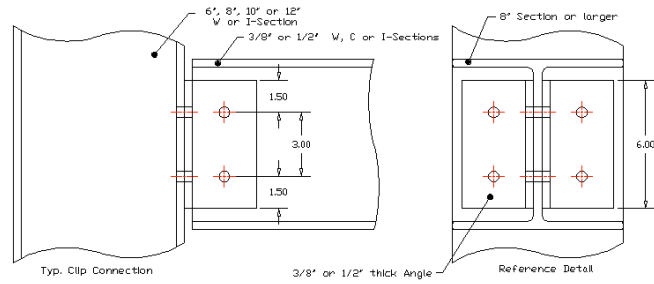

1500/1525 Series PulTex **SuperStructural** Angles

Clip Angle Thickness (in)	Angle Connection Length (in)	Bolt Hole Dia. (in)	Bolt Dia. (in)	# of Angles in Connection	# of Bolts in Shear	# of Bolts through Beam Web	# of Bolts Connected to Column	Ultimate Shear Load through Angle Heels (lbs.)	Ultimate Bearing Load of Connection (lbs.)	Allowable Bearing Load for 4% Hole Deformation (lbs.)	Clip Angle Ultimate Load before Failure (lbs.)
3/8	8 1/4	9/16	1/2	2	6	3	6	21,038	37,125	13,500	21,038
3/8	8 1/4	11/16	5/8	2	6	3	6	21,038	46,406	16,875	21,038
1/2	8 1/4	9/16	1/2	2	6	3	6	28,050	49,500	18,000	28,050
1/2	8 1/4	11/16	5/8	2	6	3	6	28,050	61,875	22,500	28,050

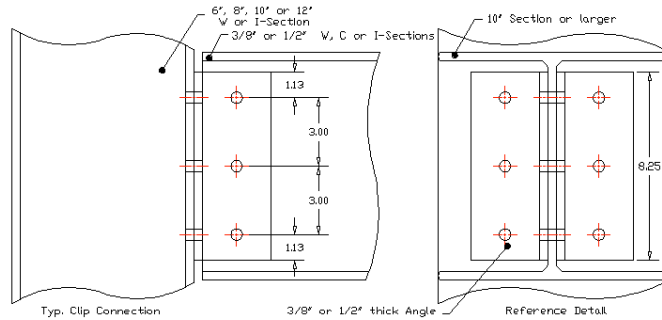

1625 Series PulTex **SuperStructural** Angles

Clip Angle Thickness (in)	Angle Connection Length (in)	Bolt Hole Dia. (in)	Bolt Dia. (in)	# of Angles in Connection	# of Bolts in Shear	# of Bolts through Beam Web	# of Bolts Connected to Column	Ultimate Shear Load through Angle Heels (lbs.)	Ultimate Bearing Load of Connection (lbs.)	Allowable Bearing Load for 4% Hole Deformation (lbs.)	Clip Angle Ultimate Load before Failure (lbs.)
3/8	4 1/2	9/16	1/2	2	4	2	4	13,163	24,750	9,000	13,163
3/8	4 1/2	11/16	5/8	2	4	2	4	13,163	30,938	11,250	13,163
1/2	4 1/2	9/16	1/2	2	4	2	4	17,550	33,000	12,000	17,550
1/2	4 1/2	11/16	5/8	2	4	2	4	17,550	41,250	15,000	17,550

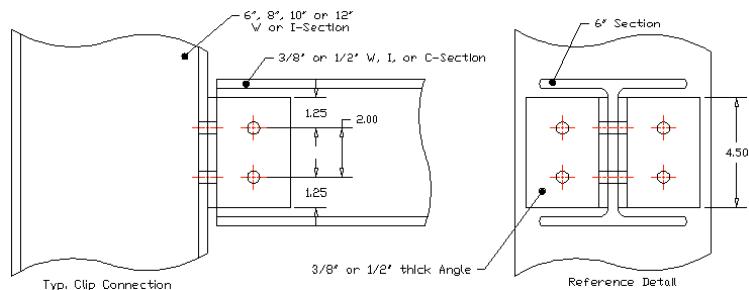

1625 Series PulTex SuperStructural Angles

Clip Angle Thickness (in)	Angle Connection Length (in)	Bolt Hole Dia. (in)	Bolt Dia. (in)	# of Angles in Connection	# of Bolts in Shear	# of Bolts through Beam Web	# of Bolts Connected to Column	Ultimate Shear Load through Angle Heels (lbs.)	Ultimate Bearing Load of Connection (lbs.)	Allowable Bearing Load for 4% Hole Deformation (lbs.)	Clip Angle Ultimate Load before Failure (lbs.)
3/8	6	9/16	1/2	2	4	2	4	17,550	24,750	9,000	17,550
3/8	6	11/16	5/8	2	4	2	4	17,550	30,938	11,250	17,550
1/2	6	9/16	1/2	2	4	2	4	23,400	33,000	12,000	23,400
1/2	6	11/16	5/8	2	4	2	4	23,400	41,250	15,000	23,400

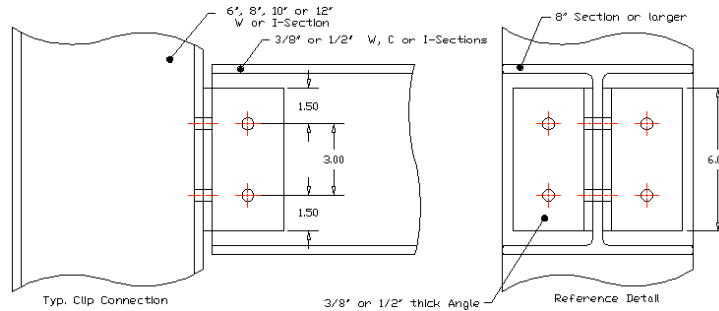

1625 Series PulTex SuperStructural Angles

Clip Angle Thickness (in)	Angle Connection Length (in)	Bolt Hole Dia. (in)	Bolt Dia. (in)	# of Angles in Connection	# of Bolts in Shear	# of Bolts through Beam Web	# of Bolts Connected to Column	Ultimate Shear Load through Angle Heels (lbs.)	Ultimate Bearing Load of Connection (lbs.)	Allowable Bearing Load for 4% Hole Deformation (lbs.)	Clip Angle Ultimate Load before Failure (lbs.)
3/8	8 1/4	9/16	1/2	2	6	3	6	24,131	37,125	13,500	24,131
3/8	8 1/4	11/16	5/8	2	6	3	6	24,131	46,406	16,875	24,131
1/2	8 1/4	9/16	1/2	2	6	3	6	32,175	49,500	18,000	32,175
1/2	8 1/4	11/16	5/8	2	6	3	6	32,175	61,875	22,500	32,175

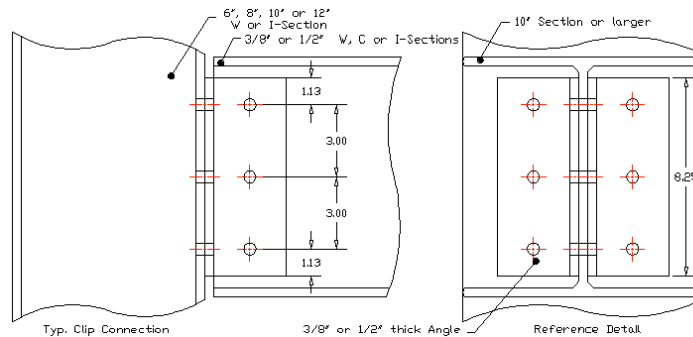

Note: The maximum slip of the connection at failure is approximately 0.35" without adhesive. The maximum slip of the connection at failure is approximately 0.101" with adhesive. The adhesive does not affect the ultimate load capacity of the connection, but does affect the amount of slip of the connection.

Bolt Hole Bearing Capacity of PulTex **SuperStructural** Beams and Columns

Tables 4-3 and 4-4 represent the bearing capacity of the flange and web sections of various beams and columns. The load table is based on the following:

1. The ultimate lengthwise bearing strength of the flange sections is 33,000 psi.
2. The ultimate crosswise bearing strength of the web section is 30,000 psi.
3. The 4% hole deformation longitudinal bearing strength of the flange is 12,000 psi.
4. The 4% hole deformation transverse bearing strength of the web is 11,000 psi.
5. No safety factors are applied.
6. Testing performed at room temperature (73°F)
7. No adhesive is used.
8. Bolt torque is not considered.

Table 4-3
Bolt Hole Bearing Capacity of PulTex **SuperStructural Columns and Beams for 1500/1525 Series**
Design Chart

Member Thickness (inches)	Bolt Diameter (inches)	# of Bolts in Column	# of Bolts in Beam	4% Hole Deformation Beam Web Bearing Load in Transverse Direction (lbs.)	Ultimate Beam Web Bearing Load in Transverse Direction (lbs.)	4% Hole Deformation Column Flange Bearing Load in Longitudinal Direction (lbs.)	Ultimate Column Flange Bearing Load in Longitudinal Direction (lbs.)
1/4	1/2	2	1	938	2,563	3,000	8,250
1/4	1/2	4	2	1,875	5,125	6,000	16,500
1/4	1/2	6	3	2,813	7,688	9,000	24,750
3/8	1/2	2	1	2,063	5,625	4,500	12,375
3/8	1/2	4	2	4,125	11,250	9,000	24,750
3/8	1/2	6	3	6,188	16,875	13,500	37,125
1/2	1/2	2	1	2,750	7,500	6,000	16,500
1/2	1/2	4	2	5,500	15,000	12,000	33,000
1/2	1/2	6	3	8,250	22,500	18,000	49,500
1/4	5/8	2	1	1,172	3,203	3,750	10,313
1/4	5/8	4	2	2,344	6,406	7,500	20,625
1/4	5/8	6	3	3,516	9,609	11,250	30,938
3/8	5/8	2	1	2,578	7,031	5,625	15,469
3/8	5/8	4	2	5,156	14,063	11,250	30,938
3/8	5/8	6	3	7,734	21,094	16,875	46,406
1/2	5/8	2	1	3,438	9,375	7,500	20,625
1/2	5/8	4	2	6,875	18,750	15,000	41,250
1/2	5/8	6	3	10,313	28,125	22,500	61,875

Note: Values are representative for bolted connections without adhesives.

Transverse bearing stress of 1/4" PulTex **SuperStructural** profiles, Web sections = 20,500 psi., 4% Elongation = 7,500 psi

Table 4-4
Hole Bearing Capacity of PulTex SuperStructural Columns and Beams for 1625 Series
Design Chart

Member Thickness (inches)	Bolt Diameter (inches)	# of Bolts in Column	# of Bolts in Beam	4% Hole Deformation		Ultimate Column Flange Bearing Load in Longitudinal Direction (lbs.)	Ultimate Column Flange Bearing Load in Longitudinal Direction (lbs.)
				Beam Web Bearing Load in Transverse Direction (lbs.)	Ultimate Beam Web Bearing Load in Transverse Direction (lbs.)		
1/4	1/2	2	1	1,175	2,938	3,500	9,500
1/4	1/2	4	2	2,350	5,875	7,000	19,000
1/4	1/2	6	3	3,525	8,813	10,500	28,500
3/8	1/2	2	1	2,372	6,469	5,250	14,250
3/8	1/2	4	2	4,744	12,938	10,500	28,500
3/8	1/2	6	3	7,116	19,406	15,750	42,750
1/2	1/2	2	1	3,163	8,625	7,000	19,000
1/2	1/2	4	2	6,325	17,250	14,000	38,000
1/2	1/2	6	3	9,488	25,875	21,000	57,000
1/4	5/8	2	1	1,469	3,672	4,375	11,875
1/4	5/8	4	2	2,938	7,344	8,750	23,750
1/4	5/8	6	3	4,406	11,016	13,125	35,625
3/8	5/8	2	1	2,965	8,086	6,563	17,813
3/8	5/8	4	2	5,930	16,172	13,125	35,625
3/8	5/8	6	3	8,895	24,258	19,688	53,438
1/2	5/8	2	1	3,953	10,781	8,750	23,750
1/2	5/8	4	2	7,906	21,563	17,500	47,500
1/2	5/8	6	3	11,859	32,344	26,250	71,250

Note: Values are representative for bolted connections without adhesives.

Transverse bearing stress of 1/4" PulTex SuperStructural profiles 1625 Series, Web sections = 23,500 psi., 4% elongation = 9,400 psi

Connection Fastener Edge Distance and Torque Level Recommendations²

Ratio of distance to fastener diameter		
	Range	Recommended
Edge Distance- End	2.0-4.5	3.0
Edge Distance- Side	1.5-3.5	2.0
Pitch (Distance between holes)	4.0-5.0	5.0

Reference: [Structural Plastics Design Manual](#)

ASTM A325	Low Torque 37.5% of Bolt Proof Load	High Torque 75% of Bolt Proof Load
Bolt Size	Torque ft-lbs. (N m)	Torque ft-lbs. (N m)
1/2" -13	29 (39)	57 (77)
5/8" - 11	57 (77)	113 (153)

Bolt recommendations based on ASTM A325 grade five coarse threaded bolts
 Connection testing performed with grade 8 oversized washers (2.5 times hole dia.)
 Proof strength for ASTM A325 bolt equals 75,000 psi (0.5 GPa)

Design Example Using the Clip Connection Charts

Task

Design a connection for a 6" x 6" x 3/8" Wide Flange Section beam that is clipped into a 8" x 8" x 3/8" Wide Flange Section column. (Reference drawing below.)

Given

Design load on connection is a static load of 6,000 lbs.

The corrosive environment requires 1625 Series.

Operating temperature = 73°F.

Minimum Safety Factor = 2.5

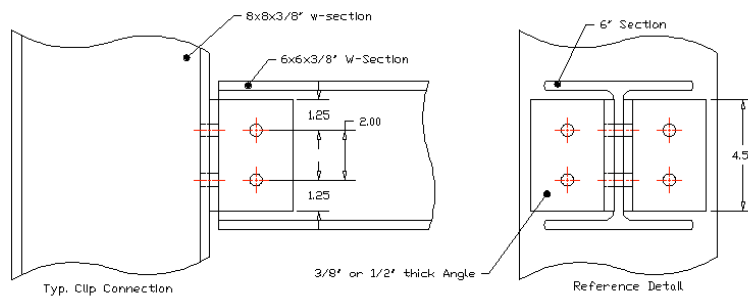

Solution:

1. Reference the 1625 Series of PulTex **SuperStructural** angle clip connection charts for the 4.5" clip angle length (depth of the 6" x 6" x 3/8" section dictates the 4.5" angle length).
2. First, investigate the 3/8" thick angles. Looking across to the **Ultimate Load Before Failure Column**, the ultimate load of the 3/8" thick clip angle connection is 13,163 lbs.
3. The design load is 6,000 lbs.(2.5 S.F.) = 15,000 lbs.; therefore, the 3/8" section is not adequate.
4. Investigate the 1/2" thick angles. The Ultimate load is 17,550 lbs.; therefore, the 1/2" angle is adequate.
5. Specify the 4" x 4" x 1/2" angle 4.5" long 1625 Series of PulTex **SuperStructural** angle.
6. Determine the bearing capacity of the two holes in the web of the 6" x 6" x 3/8" Wide Flange Section and the bearing capacity of the four holes in the column.
7. Reference the **Hole Bearing Capacity of PulTex Columns and Beams** Design Chart. Determine the row that satisfies the desired bolting condition and member sizes.
8. Enter the row for the 3/8" member thickness and two bolts in the beam. The ultimate beam web bearing load in the transverse direction is 16,172 lbs. for the 5/8" diameter bolts. The design load with the 2.5 S.F. is 15,000 lbs.; the connection is adequate.
10. From Table 1a, the column bearing load is adequate at 35,625 lbs.

Moment Capacity of PulTex **SuperStructural** Angles

Table 4-5

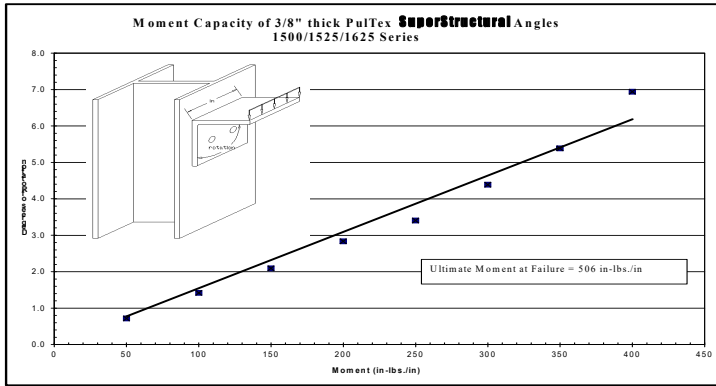

Moment capacity is in (in-lbs.) per longitudinal inch of angle

Table 4-6

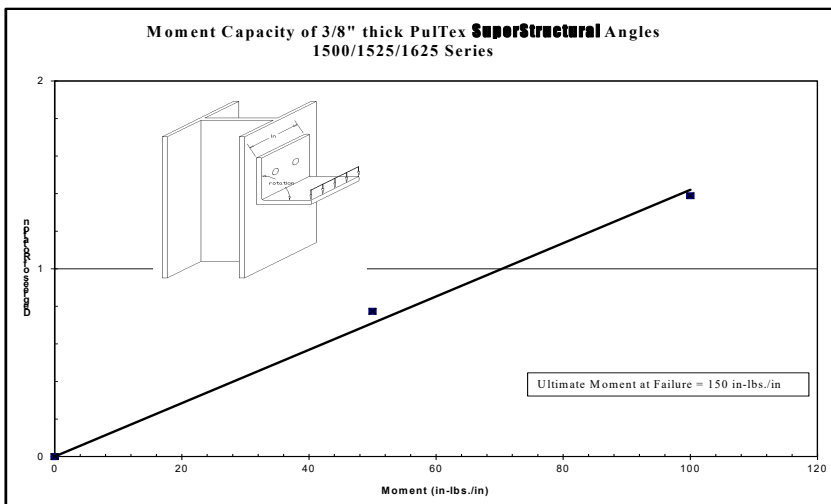

Moment capacity is in (in-lbs.) per longitudinal inch of angle

Table 4-7

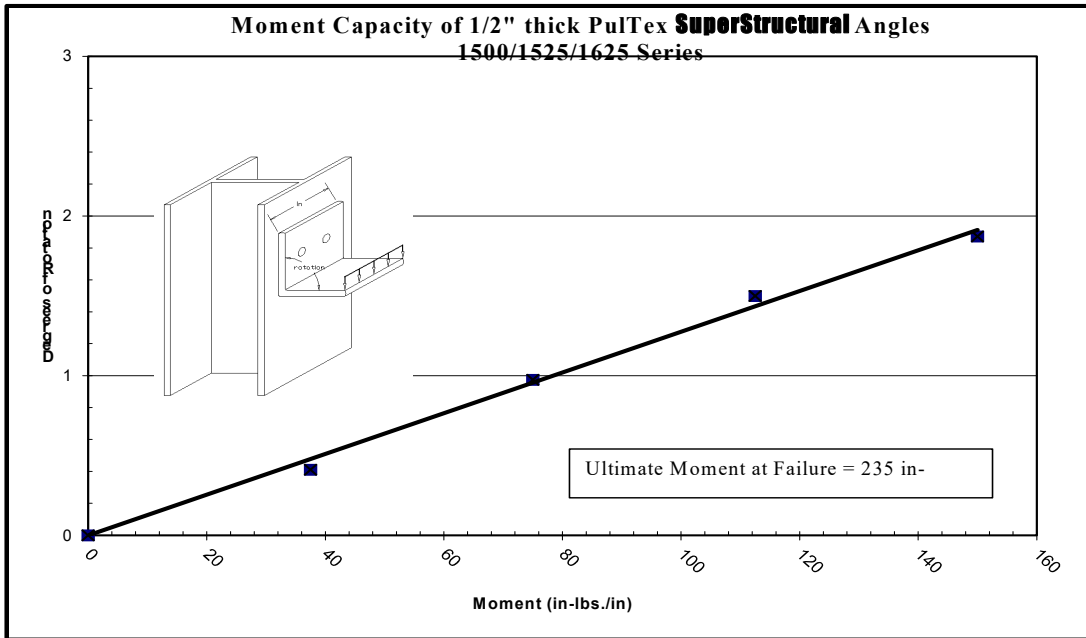

Moment capacity is in (in-lbs.) per longitudinal inch of angle

Table 4-8

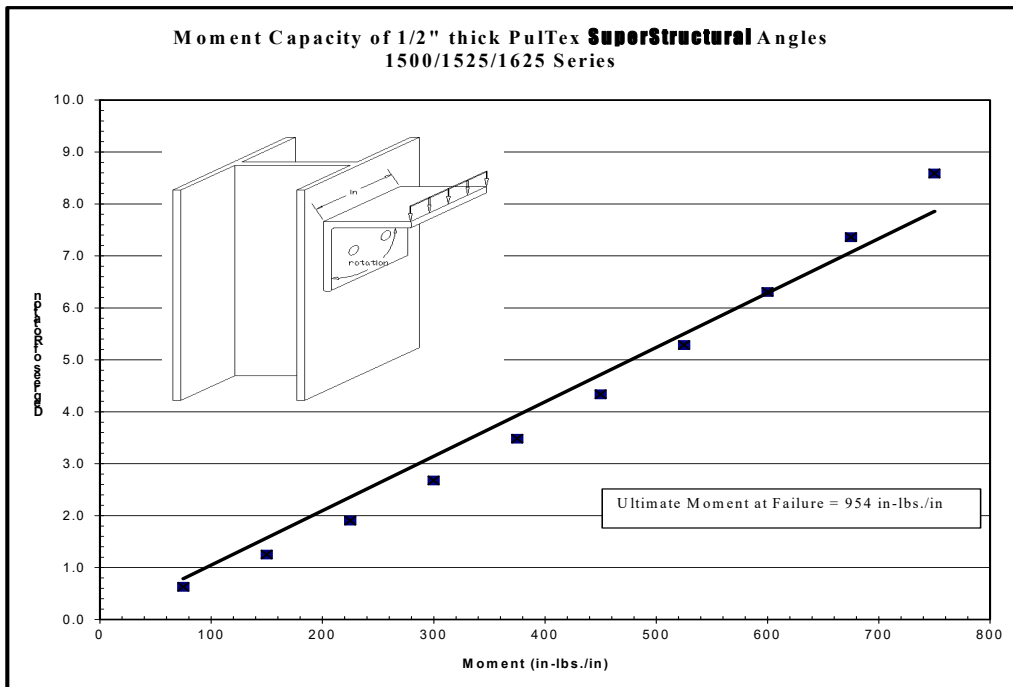

Moment capacity is in (in-lbs.) per longitudinal inch of angle

Designing a Connection With a Coped Flange

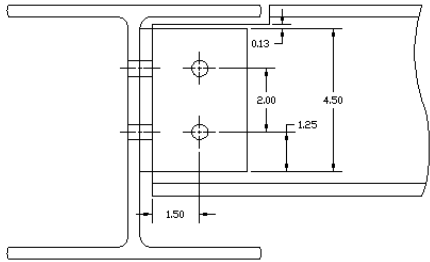

Figure 4-1

Coped Flange Connection

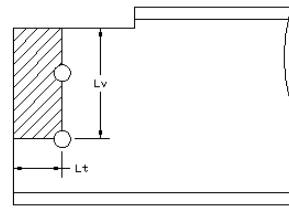

Figure 4-2

When designing a connection with a coped flange, block shear must be checked to insure that the connection is adequate. The two factors affecting block shear are the transverse tensile and shear strengths of the web section of the beam. Values for transverse tensile strength and in-plane shear strengths can be located in the Material Properties Sheets of PulTex Fiber Reinforced Polymer Structural Profiles and PulTex **SuperStructural** Profiles for Wide Flange Sections and I-Sections.

The procedure for determining the block shear (V_{block}) allowable load is as follows:

1. Determine the in-plane shear and tensile strengths of the beam profile with which you are designing. (Material Properties Sheets of PulTex Fiber Reinforced Polymer Structural Profiles and PulTex **SuperStructural** Profiles for Wide Flange Sections and I-Sections).
2. Determine the shear length (L_v) of the bolted connection. (Reference Figure 4-2)
3. Determine the net tensile length (L_t) of the bolted connection. (Reference Figure 4-2)
4. Apply the proper safety factors to the connection. (Use “2” for demonstration.)
Determine if V_{block} allowable is greater than the design load.

Example

Design a framed connection using a PulTex **SuperStructural** 6" x 6" x 3/8" Wide Flange Section coped into an PulTex **SuperStructural** 8" x 8" x 3/8" beam. The holes are 9/16" to accommodate 1/2" bolts. (Reference Figure 4-1)

1. Referencing the Material Properties Sheets for PulTex **SuperStructural** Profiles, the in-plane shear and tensile strengths of the web section are 7,000 psi and 10,500 psi, respectively.
2. Calculate the shear length (L_v) of the Figure 1. connection,
i.e., $(.130 + 2 + 1.25 - 9/16 - 9/32) = 2.53"$
3. Calculate the net tension length (L_t) of the above connection,
i.e., $(1.5 - .5(9/16)) = 1.219"$
4. Apply the proper safety factors to the transverse shear and tensile strengths,
i.e., (Allowable shear = $7,000/2 = 3,500$ psi)
(Allowable tension = $10,500/2 = 5,250$ psi)
5. Calculate the allowable shear force for block shear V_{block}
i.e., $(5000(1.219)(.375) + 3,500(2.53)(.375) = 5,720$ lbs.
6. Compare V_{block} allowable to the design load.³

Endnotes

¹ Task Committee on Design of the Structural Plastics Research Council of the Technical Council on Research of the American Society of Civil Engineers. Structural Plastics Design Manual Vol. 2. New York: American Society of Civil Engineers, 1984, pg. 732.

² Task Committee on Design of the Structural Plastics Research Council of the Technical Council on Research of the American Society of Civil Engineers. Structural Plastics Design Manual Vol. 1. New York: American Society of Civil Engineers, 1984, pg. 439.

³ Bank, L.C. "Bolted Connections for Pultruded Frame Structures." Diss. The Catholic University of America, 1996, pg. 29.

⁴Boresi, A.P. and Schmidt, R.J. 2003. *Advanced Mechanics of Materials*. 6th edition, John Wiley & Sons, Inc. New York, NY.

⁵Pandey, M.D., Kabir, M.Z., and Sherbourne, A.N. 1995. "Flexural-torsional stability of thin-walled composite I-section beams," *Composites Engineering*, 5(3): 321-342.

⁶Qiao, P.Z, Davalos, J.F., and Wang, J.L. 2001. "Local buckling of composite FRP shapes by discrete plate analysis," *Journal of Structural Engineering*, ASCE, 127 (3): 245-255.

⁷Qiao, P.Z. and Zou, G.P. 2003. "Local Buckling of Composite Fiber-Reinforced Plastic Wide-Flange Sections," *Journal of Structural Engineering*, ASCE, 129(1): 125-129.

⁸Qiao, P.Z. and Zou, G.P. (2002). "Local Buckling of Elastically Restrained Fiber-Reinforced Plastic Plates and its Applications to Box-Sections," *Journal of Engineering Mechanics*, ASCE, 128 (12): 1324-1330.

⁹Qiao, P.Z. 2003. "Design equations and guidelines for fiber-reinforced polymer (FRP) composite channel sections," Final Report to Creative Pultrusions, Inc., July 2003. 36 pages.

Chapter 5 Load Tables for Compression Members

The objective of Chapter 5 is to provide engineers with a quantifiable baseline for designing with PulTex FRP columns. Creative Pultrusions, through its comprehensive column load test program, provides the most current, thorough manual for the practical design of PulTex FRP columns. Full section column tests were performed by Professor Robert L. Yuan, Ph.D., P.E., at The University of Texas at Arlington, Arlington, Texas. The protocol of full section column tests included more than 300 structural PulTex FRP product specimens: I, W, Round, Square and Angle Sections.

The test protocol required the analysis of short, intermediate and long columns, ranging from one to twenty foot section lengths. The tests were conducted in a reaction frame in the vertical position, using pinned-pinned end conditions, with the corresponding effective length coefficient (K) of one. Column design equations, for practical column applications with various end conditions, are available and completely supported by the extensive column load test results.

The columns were axially compressed, with measurements taken of the axial deflections and lateral center displacements. Axial load versus lateral displacements were plotted and the ultimate loads determined. The ultimate load is defined as the points on the plots, where the loads no longer increase due to local, global or bearing failure.

Creative Pultrusions recognizes that some published results for column load information are inconsistent within the pultrusion industry. The column load tests, conducted by Creative Pultrusions, used true pinned-pinned end conditions with minimum friction effects. The results of this testing protocol correspond to a strong baseline confidence to which engineers can design and provide conclusions.

Introduction

The research work presented in the Load Tables for Compression Members represents a thorough investigation on the behavior of PulTex FRP columns, produced by Creative Pultrusions, to be used as supporting members for civil engineering structures.

Five section configurations of PulTex FRP composite columns are studied in the research, as shown in Figure 5-1. Two sections have closed configurations: square tube and round tube; the other three are thin-walled open sections: wide-flange, I, and angle sections. More than 300 column members, with three specimens each, were tested.

Figure 5-1

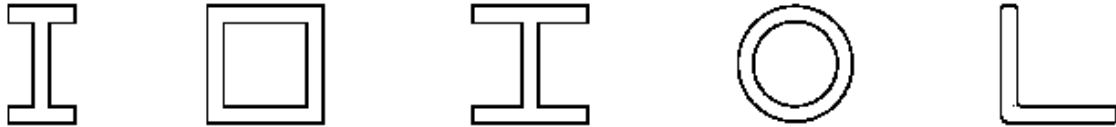

The thicknesses are 1/8" and 1/4" for square tube sections. The dimensions of the square tubes vary from 1.5" to 4". For round tube sections, the thicknesses are 1/8" and 1/4". The diameters of the round tube are 1.5" and 2". For Wide Flange Sections, the thicknesses of flanges and webs are 1/4" and 3/8". The dimension of the Wide Flange Section ranges from 4" to 10". For I-Sections, the thicknesses of flanges and webs are 1/4" and 3/8". The dimensions of I-Sections are 4" x 2" and 8" x 4". For angle sections, the thicknesses of the flanges are 1/4", 3/8" and 1/2". The dimensions of the angle section are 3" x 3", 4" x 4" and 6" x 6".

The objectives of the research are to provide:

1. the column load data for five section configurations, taking into consideration the length of the column and the effective length factor, "K";
2. the allowable compressive stresses;
3. the allowable axial compressive loads;
4. software and/or design equations for predicting load capacity of columns with various section configurations; and
5. written explanations to relate experimental data with the design equations and procedures.

PulTex FRP Column Test Program

The length of the composite column varies from 1' to 20' to include short, intermediate, and long column members. Full scale column tests are performed by an axial compressive load in a vertical position as shown in Figure 5-2.

Figure 5-2



MTS Machine

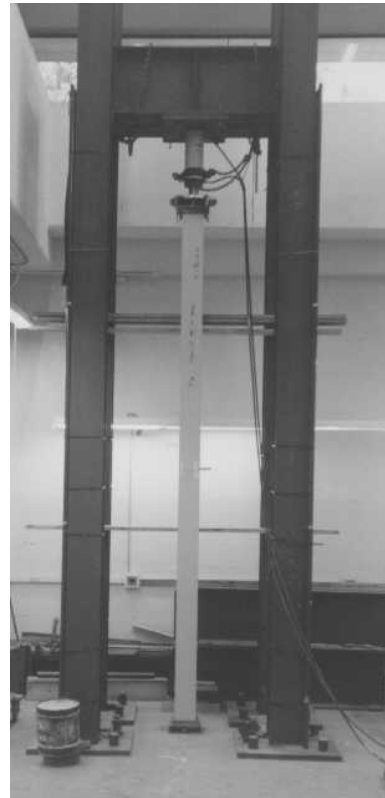

Reaction Frame

Short vertical column members were tested on a MTS machine; long column members were tested on a 30-ft. reaction frame. During the test, a microprofiler was used to generate the displacement rate of loading at a 0.1 in./min. The measurements included strains, ultimate loads, axial displacements and lateral deflections.

The composite materials for the column members are constructed of polyester-based and vinyl ester-based resin matrices, with and without fire retardancy, reinforced with E-glass fibers.

Analysis and Discussion

Columns with Box Sections (Imperial)

For the short columns with box sections, the ultimate load capacity is a function of the bearing strength of the composite material and the column cross-sectional area. In general, the bearing strength of a structural composite is approximately 30 ksi; therefore, the ultimate strength of short columns with box sections depends upon the cross-sectional area; for a given area, the columns with box sections appear to have the highest ultimate load capacities among the columns with other section configurations. For a given wall thickness of a box section, the ultimate load capacity appears to increase linearly with an increase in the section dimensions, e.g., for thickness $t = 1/4$ ", length $L = 2$ ft., the ultimate load strength was 40 kips for $1\ 3/4$ " x $1\ 3/4$ " box section; 58 kips for 2 " x 2 " section; and 88 kips for a 3 " x 3 " section.

For the long columns, the ultimate column strength is a function of the slenderness ratio KL/r . The column strength decreases with an increase in the slenderness ratio. For columns with box sections, the dividing line at the slenderness ratio for short and long columns appears to be 35. For columns with KL/r less than 35, the bearing strength of the composite controls the ultimate load. For columns with KL/r greater than 35, global buckling strength controls the ultimate load.

Columns with Round Sections

Similar to the columns with box sections, the ultimate load capacity of the short round column is also a function of the bearing strength of the composites and column cross-sectional area. For a given area and length, the ultimate column strength of a short round column is approximately 20% less than that of a short box column.

For the long round columns, the ultimate column strength is a function of the slenderness ratio KL/r . The round column strength decreases with an increase in the slenderness ratio. For round columns, the dividing line at the slenderness ratio appears to be between 30 to 40. For round columns with KL/r greater than 40, the columns have the characterization of an Euler behavior. For round columns with KL/r less than 30, bearing mode of failure dominates the ultimate column strength. At $KL/r = 25$, the ultimate stress of the round column from test results is less than the bearing strength of 30 ksi of the composites; therefore, the prediction curve in the short round column region becomes an inclined straight line.

Columns with Wide Flange Sections

From experimental results, the ultimate strength of columns with Wide Flange Sections is about 30 percent of the ultimate strength of columns with box sections for a given cross-sectional dimension and member length.

For the long columns, the ultimate column strength is a function of the slenderness ratio KL/r . The column strength decreases with an increase in the slenderness ratio. For columns with Wide Flange Sections, the dividing line at the slenderness ratio for short and long columns appears to be in the range of 40 to 60. For columns with KL/r less than 60, the column ultimate load depends on one-half of the flange width to the flange thickness ratio of $b_f/2t_f$. The higher the $b_f/2t_f$ ratio, the less the ultimate load capacity.

Columns with I-Sections

Similar to the columns with Wide Flange Sections, the ultimate load capacity of the columns with I-sections is a function of the slenderness ratio KL/r . The column strength decreases with an increase in the slenderness ratio. For columns with I-sections, the dividing line at the slenderness ratio for short and long columns appears to be in the range of 30 to 40. For columns with KL/r greater than 40, the Euler characteristics of the column with I-sections are close to that of the column with Wide Flange Sections; however, for I-section columns with KL/r less than 30, the ultimate stress is significantly higher than the ultimate stress of the Wide Flange Section column due to a smaller b_f/t_f ratio. The crippling of the flange in the testing of I-section columns was not observed. At $KL/r = 30$, the ultimate stress of the I-section column from test results is less than the bearing strength of 30 ksi of the composites; therefore, the prediction curve in short I-section column regions becomes an inclined straight line.

Columns with Angle Sections

Columns with angle sections were axially loaded at the centroid of the section. The ultimate load capacity is a function of the slenderness ratio KL/r . The column strength decreases with an increase in the slenderness ratio. For columns with angle sections, the dividing line at the slenderness ratio for short and long columns appears to be in the range of 45 to 60. For columns with KL/r greater than 60, the Euler characteristics of the column with angle section is close to that of the column with Wide Flange Sections; however, for the angle-section columns with KL/r less than 45, the ultimate stress is significantly lower than that of the Wide Flange Section columns due to a larger b_f/t_f ratio and localized instability. The crippling of the flange in the testing of angle-section columns was observed for all specimens; the local buckling instigated a torsion and global buckling of the column. In the short angle section column region, the ultimate column strength is sensitive to the b_f/t_f ratio. For a b_f/t_f greater than 8, the ultimate strength of the column with angle section decreases significantly.

Column Load Design Equations

The Column Load Design Equations for E-glass reinforced polymer columns are based on a large group of data points from full section tests of composite columns. The observed column failure can be categorized into two modes: bearing failure and local/global instability. Figure 5-3 depicts a general behavior for all fiber reinforced polymer columns. The curve can be divided into two groups: short column and long column, as the plotted compressive stress versus slenderness ratio. The short columns generally fail in bearing deformation or local buckling mode; the long columns generally fail in the global buckling mode.

Compressive Stress vs. Slenderness Ratio

Figure 5-3

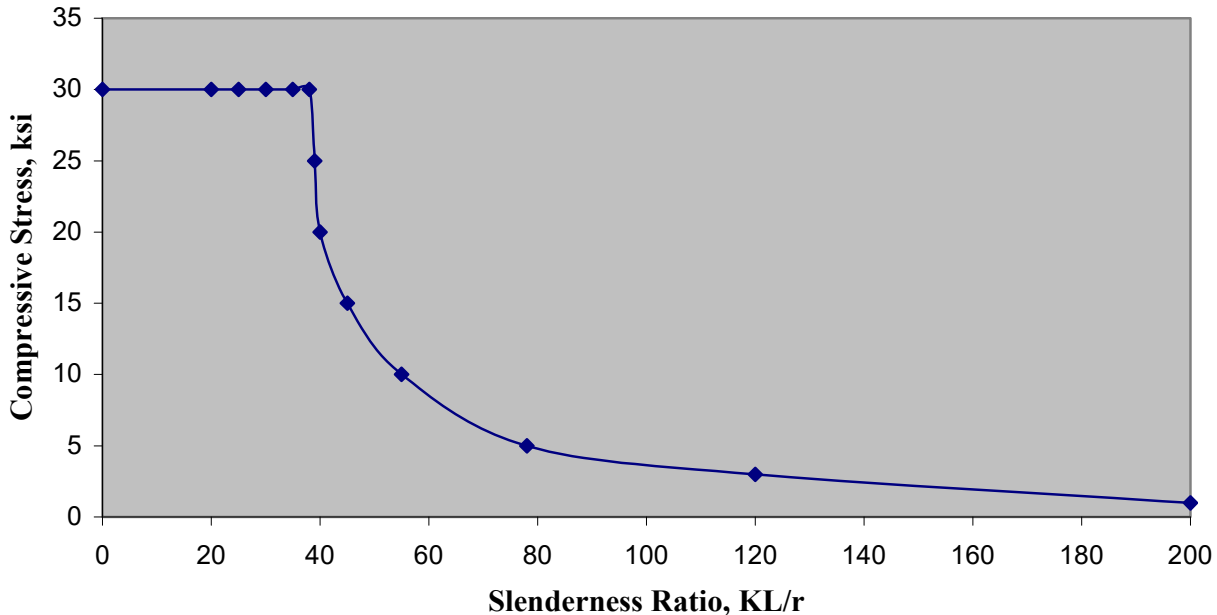

Design Equations for Box Sections

For short columns with box sections, a bearing failure due to axial compressive loading governs the design equation as follows:

$$\sigma_{ult} = \frac{P_{ult}}{A}$$

Where P_{ult}	=	Ultimate axial load (lbs.)
A	=	Cross-sectional area (in ²)
σ_{ult}	=	Bearing strength of the composite (psi)

Columns with Round- and I-Sections

For short columns with round- and I-sections, the columns fail due to a combination of axial load and bending moment. The design equations consider the interaction of bearing and flexural buckling failure. A linear equation is developed from the test results for the transition behavior as follows:

$$\sigma_{ult} = 30 - \frac{1}{7} \frac{KL}{r} \quad (\text{ksi}) \quad \text{for short Pultex}^{\text{®}} \text{FRP Round- Section columns (2)}$$

$$\sigma_{ult} = 25 - \frac{5}{38} \frac{KL}{r} \quad (\text{ksi}) \quad \text{for short Pultex}^{\text{®}} \text{FRP I-Section columns (3)}$$

Where	σ_{ult}	=	Ultimate compressive stress (ksi)
	K	=	Effective length coefficient
	L	=	Column length (in) when used in above equation
	r	=	Radius of gyration of the section (in)

Columns with Wide Flange Sections

For short columns with Wide Flange Sections, local buckling or crippling occurs on the flanges. According to the test results, the ultimate local buckling stress, $\sigma_{ult,l}$ of the PulTex FRP composite Wide Flange Section column can be predicted by the modified buckling equation of thin plate for isotropic materials as follows:

$$\sigma_{ult} = \Phi k \frac{\pi^2 E}{12(1-\nu^2)} \left(\frac{t_f}{b_f} \right)^2 \quad (\text{psi}) \quad \text{for short Pultex}^{\text{®}} \text{FRP Wide Flange Section columns (4)}$$

Where:	E	=	Modulus of elasticity in the loading direction (psi)
	ν	=	Poisson's ratio
	t_f	=	Thickness of the local flange element (in)
	b_f	=	Width of the local flange element (in)
	Φ	=	0.8, a coefficient to account for the orthotropic material of the composite
	k	=	0.5 is recommended for the non-stiffened outstanding flanges of the Wide Flange Section
	k	=	4.0 is recommended for the stiffened outstanding webs of the Wide Flange

Section

It should be noted that the ultimate local buckling strength needs to be checked against bearing strength. The lower value will be used for the ultimate strength of the short composite column with the Wide Flange Section. Then, the ultimate strength of the short column is compared with the flexural buckling strength to determine the dividing point for short and long columns.

Columns with Angle Sections

For short columns with angle sections, the local buckling of the flange occurs, as in the column with the Wide Flange Section. Thus, the design Equation (4) can also be applied to predict the ultimate strength of the short columns with angle sections.

Design Equations for Long Columns

The flexural buckling, known as Euler buckling, is the general behavior of long, slender PulTex FRP columns under axial compression loads. According to the test results, the ultimate buckling strength of the composite columns was in agreement with the Euler buckling equation:

(psi) for all long Pultex[®] FRP columns (5)

$$\sigma_{ult,Euler} = \frac{\pi^2 E}{\left(\frac{KL}{r}\right)^2}$$

The equation can be applied to the long PulTex FRP composite columns with square-, round-, I-, W-, and angle- sections; however, for columns with angle-sections, flexural-torsional buckling governs the ultimate strength. In the test, the coupling of the flexural and torsional buckling was observed in a form of lateral deflection and global twisting for the angle-section columns. The ultimate flexural-torsional buckling stress can be approximated by the lower value from equation (5) for flexural buckling strength about the weak axis, or from the torsional buckling equation as follows:

$$\sigma_{ult, ft} = \Phi \frac{E}{2(1 + \nu)} \left(\frac{t_f}{b_f}\right)^2 \text{ (psi) for short PulTex FRP Angle columns (6)}$$

According to the test results, the coefficient $\Phi = 0.8$ is recommended for Equation (6) to account for the orthotropic material of the composite, where b_f is the width of the local flange element (in); one-half the width for Wide Flange Sections; whole leg width for angle sections.

The effective length coefficient, “K-value”, in the equation, accounts for the different end conditions. The “K-value” is recommended in Table 1. for PulTex FRP composite columns with various end supports.

Table 5-1 Effective Length Coefficient, K-Value

End Conditions	Recommended K-Value
1. Pinned-Pinned	1.00
2. Fixed-Fixed	0.65
3. Pinned-Fixed	0.80
4. Fixed-Translation Fixed	1.20
5. Fixed-Translation Free	2.10
6. Pinned-Translation Fixed	2.00

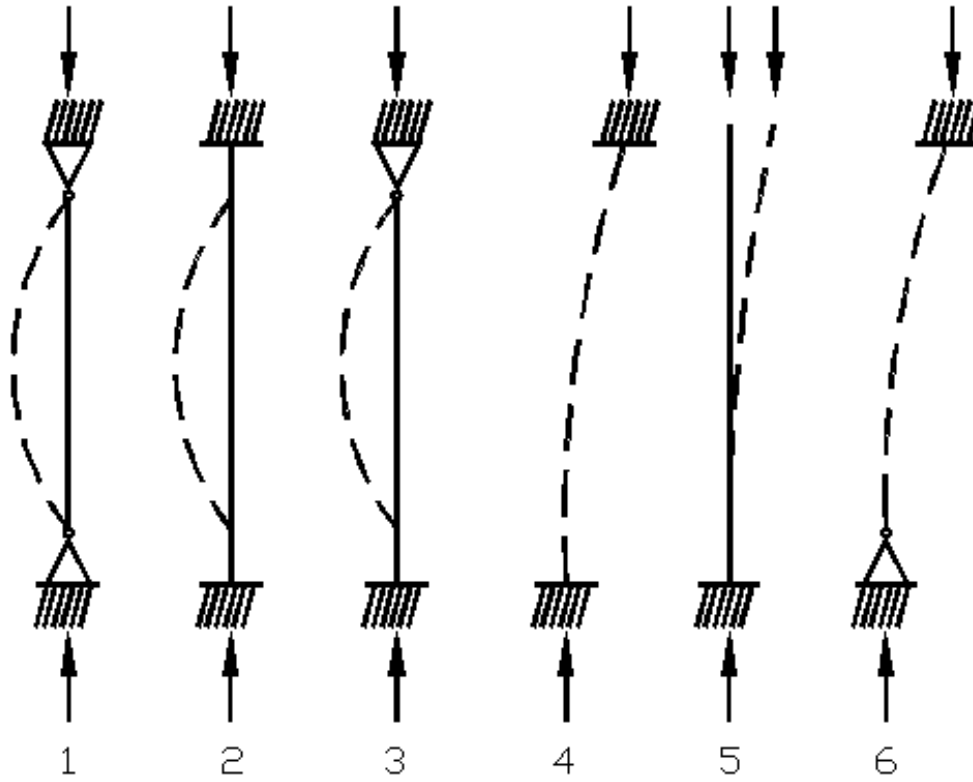

Note: Buckled Shape of Column Displayed by Dashed Line

Nomenclature

A	= Cross-sectional area (in ²)
b _f	= Width of local flange element; width of angle leg or ½ width of a Wide Flange Beam (in)
E	= Modulus of elasticity in the loading direction (psi)
F _a	= Allowable compressive stress (psi)
I _x , I _y	= Moment of Inertia (in ⁴)
k	= Flange stiffness factor 0.5 for non-stiffened outstanding flanges of the Wide Flange Section; 4.0 for stiffened
K	= Effective length coefficient
L	= Length of column (ft); (in) when used in KL/r equation
P _a	= Allowable axial load (lbs.)
r	= Radius of gyration of the section (in)
S	= Section Modulus (in ³)
t _f	= Thickness of local flange element (in)
ν	= Poisson's Ratio (.36 in/in)
Φ	= 0.8, a coefficient to account for the orthotropic material of the composite
σ _{ult}	= Ultimate compressive or bearing stress of the composite (psi)
σ _{ult,l}	= Ultimate local buckling stress (psi)
σ _{ult,Euler}	= Ultimate Euler buckling stress (psi)
σ _{ult,ft}	= Ultimate flexural-torsional buckling stress (psi)

Tables for Allowable Compressive Stresses and Loads

The following tables provide information for the allowable stresses (F_a) and the allowable loads (P_a) for columns with square tube sections, round sections, Wide Flange Sections, I-sections and angle-sections. The tables represent sections used as compressive members (columns). The tables were developed based on the following criteria:

1. Experimental test results
2. Room temperature (73° F)
3. A safety factor of S.F. = 3.0
4. A value of $K = 1.0$
5. A value of $E = 3 \times 10^6$ psi
6. $\nu = .36$ in/in
7. No damages on the composite columns
8. Tables display KL/r values to 200 for reference. It is recommended that KL/r be limited to 120.

Tables for Allowable Compressive Stresses and Loads

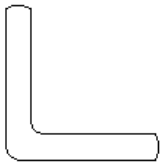

PulTex Standard Structural Profiles Equal Leg Angles

2" x 2" x 1/4" (Part# AE 240) PulTex1500/1525/1625 Series A = .92 in², r_z = .38 in Allowable Axial Stresses and Loads				
Effective Column Length (KL) (ft.)	KL/r	Fa (psi)	Pa (lbs.)	
1.0	31.5	4596	4237	Short Column
1.5	47.2	4427	4081	Long Column
2.0	63.0	2490	2296	Long Column
2.5	78.7	1594	1469	Long Column
3.0	94.4	1107	1020	Long Column
3.5	110.2	813	750	Long Column
4.0	125.9	622	574	Long Column
4.5	141.7	492	453	Long Column
5.0	157.4	398	367	Long Column
5.5	173.1	329	304	Long Column
6.0	188.9	277	255	Long Column
6.5	204.6	236	217	Long Column
7.0	220.4	203	187	Long Column
7.5	236.1	177	163	Long Column
8.0	251.8	156	143	Long Column

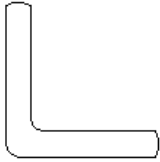

**PulTex Standard Structural Profiles
Equal Leg Angles**

3" x 3" x 1/4" (Part# AE 340)
PulTex 1500/1525/1625 Series
A = 1.42 in², r_z = .58 in
Allowable Axial Stresses and Loads

Effective Column Length (KL) (ft.)	KL/r	Fa (psi)	Pa (lbs.)	
1.0	20.6	2042	2904	Short Column
1.5	30.8	2042	2904	Short Column
2.0	41.1	2042	2904	Short Column
2.5	51.4	2042	2904	Short Column
3.0	61.7	2042	2904	Short Column
3.5	72.0	1906	2710	Long Column
4.0	82.2	1459	2075	Long Column
4.5	92.5	1153	1639	Long Column
5.0	102.8	934	1328	Long Column
5.5	113.1	772	1097	Long Column
6.0	123.4	648	922	Long Column
6.5	133.7	553	786	Long Column
7.0	143.9	476	677	Long Column
7.5	154.2	415	590	Long Column
8.0	164.5	365	519	Long Column
8.5	174.8	323	459	Long Column
9.0	185.1	288	410	Long Column
9.5	195.3	259	368	Long Column
10.0	205.6	233	332	Long Column

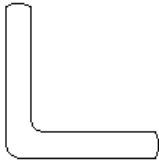

**PulTex Standard Structural Profiles
Equal Leg Angles**

3" x 3" x 3/8" (Part# AE 360)				
PulTex 1500/1525/1625 Series				
A = 2.1 in², r_z = .58 in				
Allowable Axial Stresses and Loads				
Effective Column Length (KL) (ft.)	KL/r	Fa (psi)	Pa (lbs.)	
1.0	20.8	4596	9591	Short Column
1.5	31.1	4596	9591	Short Column
2.0	41.5	4596	9591	Short Column
2.5	51.9	3662	7644	Long Column
3.0	62.3	2543	5308	Long Column
3.5	72.7	1869	3900	Long Column
4.0	83.1	1431	2986	Long Column
4.5	93.4	1130	2359	Long Column
5.0	103.8	916	1911	Long Column
5.5	114.2	757	1579	Long Column
6.0	124.6	636	1327	Long Column
6.5	135.0	542	1131	Long Column
7.0	145.4	467	975	Long Column
7.5	155.7	407	849	Long Column
8.0	166.1	358	746	Long Column
8.5	176.5	317	661	Long Column
9.0	186.9	283	590	Long Column
9.5	197.3	254	529	Long Column
10.0	207.6	229	478	Long Column
11.0	228.4	189	395	Long Column
12.0	249.2	159	332	Long Column

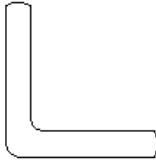

**PulTex Standard Structural Profiles
Equal Leg Angles**

4" x 4" x 1/4" (Part# AE 440)
PulTex 1500/1525/1625 Series
 $A = 1.92 \text{ in}^2$, $r_z = .79 \text{ in}$
Allowable Axial Stresses and Loads

Effective Column Length (KL) (ft.)	KL/r	Fa (psi)	Pa (lbs.)	
1.0	15.2	1149	2208	Short Column
1.5	22.9	1149	2208	Short Column
2.0	30.5	1149	2208	Short Column
2.5	38.1	1149	2208	Short Column
3.0	45.7	1149	2208	Short Column
3.5	53.4	1149	2208	Short Column
4.0	61.0	1149	2208	Short Column
4.5	68.6	1149	2208	Short Column
5.0	76.2	1149	2208	Short Column
5.5	83.9	1149	2208	Short Column
6.0	91.5	1149	2208	Short Column
6.5	99.1	1005	1931	Long Column
7.0	106.7	866	1665	Long Column
7.5	114.4	754	1450	Long Column
8.0	122.0	663	1275	Long Column
8.5	129.6	587	1129	Long Column
9.0	137.2	524	1007	Long Column
9.5	144.9	470	904	Long Column
10.0	152.5	424	816	Long Column
11.0	167.7	351	674	Long Column
12.0	183.0	295	566	Long Column
13.0	198.2	251	483	Long Column
14.0	213.5	217	416	Long Column

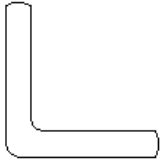

**PulTex Standard Structural Profiles
Equal Leg Angles**

4" x 4" x 3/8" (Part# AE 460)
PulTex 1500/1525/1625 Series
A = 2.84 in², r_z = .78 in
Allowable Axial Stresses and Loads

Effective Column Length (KL) (ft.)	KL/r	Fa (psi)	Pa (lbs.)	
1.0	15.4	2585	7334	Short Column
1.5	23.1	2585	7334	Short Column
2.0	30.8	2585	7334	Short Column
2.5	38.5	2585	7334	Short Column
3.0	46.2	2585	7334	Short Column
3.5	53.9	2585	7334	Short Column
4.0	61.6	2585	7334	Short Column
4.5	69.3	2057	5835	Long Column
5.0	77.0	1666	4726	Long Column
5.5	84.7	1377	3906	Long Column
6.0	92.4	1157	3282	Long Column
6.5	100.1	986	2797	Long Column
7.0	107.8	850	2411	Long Column
7.5	115.5	740	2101	Long Column
8.0	123.2	651	1846	Long Column
8.5	130.9	576	1635	Long Column
9.0	138.6	514	1459	Long Column
9.5	146.2	461	1309	Long Column
10.0	153.9	416	1182	Long Column
11.0	169.3	344	976	Long Column
12.0	184.7	289	821	Long Column
13.0	200.1	246	699	Long Column
14.0	215.5	212	603	Long Column

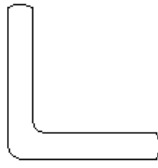

**PulTex Standard Structural Profiles
Equal Leg Angles**

4" x 4" x 1/2" (Part# AE 480) PulTex 1500/1525/1625 Series A = 3.72 in², r_z = .78 in Allowable Axial Stresses and Loads				
Effective Column Length (KL) (ft.)	KL/r	Fa (psi)	Pa (lbs.)	
1.0	15.5	4596	17087	Short Column
1.5	23.3	4596	17087	Short Column
2.0	31.0	4596	17087	Short Column
2.5	38.8	4596	17087	Short Column
3.0	46.5	4558	16946	Long Column
3.5	54.3	3348	12450	Long Column
4.0	62.0	2564	9532	Long Column
4.5	69.8	2026	7531	Long Column
5.0	77.6	1641	6100	Long Column
5.5	85.3	1356	5042	Long Column
6.0	93.1	1139	4236	Long Column
6.5	100.8	971	3610	Long Column
7.0	108.6	837	3112	Long Column
7.5	116.3	729	2711	Long Column
8.0	124.1	641	2383	Long Column
8.5	131.9	568	2111	Long Column
9.0	139.6	506	1883	Long Column
9.5	147.4	454	1690	Long Column
10.0	155.1	410	1525	Long Column
11.0	170.6	339	1260	Long Column
12.0	186.1	285	1059	Long Column
13.0	201.7	243	902	Long Column
14.0	217.2	209	778	Long Column
15.0	232.7	182	678	Long Column
16.0	248.2	160	596	Long Column

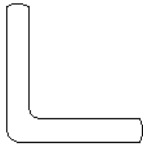

**PulTex Standard Structural Profiles
Equal Leg Angles**

6" x 6" x 3/8" (Part# AE 660) PulTex 1500/1525/1625 Series A = 4.34 in², r_z = 1.18 in Allowable Axial Stresses and Loads				
Effective Column Length (KL) (ft.)	KL/r	Fa (psi)	Pa (lbs.)	
1.0	10.1	1149	4983	Short Column
1.5	15.2	1149	4983	Short Column
2.0	20.2	1149	4983	Short Column
2.5	25.3	1149	4983	Short Column
3.0	30.4	1149	4983	Short Column
3.5	35.4	1149	4983	Short Column
4.0	40.5	1149	4983	Short Column
4.5	45.6	1149	4983	Short Column
5.0	50.6	1149	4983	Short Column
5.5	55.7	1149	4983	Short Column
6.0	60.7	1149	4983	Short Column
6.5	65.8	1149	4983	Short Column
7.0	70.9	1149	4983	Short Column
7.5	75.9	1149	4983	Short Column
8.0	81.0	1149	4983	Short Column
8.5	86.1	1149	4983	Short Column
9.0	91.1	1149	4983	Short Column
9.5	96.2	1067	4627	Long Column
10.0	101.2	963	4176	Long Column
10.5	106.3	873	3787	Long Column
11.0	111.4	796	3451	Long Column
11.0	111.4	796	3451	Long Column
12.0	121.5	669	2900	Long Column
12.5	126.6	616	2672	Long Column
13.0	131.6	570	2471	Long Column
13.5	136.7	528	2291	Long Column
14.0	141.7	491	2130	Long Column
14.5	146.8	458	1986	Long Column
15.0	151.9	428	1856	Long Column
15.5	156.9	401	1738	Long Column
16.0	162.0	376	1631	Long Column
16.5	167.1	354	1534	Long Column
17.0	172.1	333	1445	Long Column
17.5	177.2	314	1363	Long Column
18.0	182.2	297	1289	Long Column
18.5	187.3	281	1220	Long Column
19.0	192.4	267	1157	Long Column
19.5	197.4	253	1098	Long Column
20.0	202.5	241	1044	Long Column

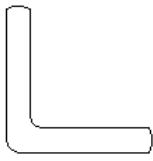

**PulTex Standard Structural Profiles
Equal Leg Angles**

6" x 6" x 1/2" (Part# AE 680)
PulTex 1500/1525/1625 Series
A = 5.72 in², r_z = 1.18 in
Allowable Axial Stresses and Loads

Effective Column Length (KL) (ft.)	KL/r	Fa (psi)	Pa (lbs.)	
1.0	10.2	2042	11679	Short Column
1.5	15.3	2042	11679	Short Column
2.0	20.4	2042	11679	Short Column
2.5	25.5	2042	11679	Short Column
3.0	30.6	2042	11679	Short Column
3.5	35.7	2042	11679	Short Column
4.0	40.8	2042	11679	Short Column
4.5	45.9	2042	11679	Short Column
5.0	51.0	2042	11679	Short Column
5.5	56.1	2042	11679	Short Column
6.0	61.2	2042	11679	Short Column
6.5	66.3	2042	11679	Short Column
7.0	71.4	1937	11077	Long Column
7.5	76.5	1687	9649	Long Column
8.0	81.6	1483	8481	Long Column
8.5	86.7	1314	7512	Long Column
9.0	91.8	1172	6701	Long Column
9.5	96.9	1052	6014	Long Column
10.0	102.0	949	5428	Long Column
10.5	107.1	861	4923	Long Column
11.0	112.2	784	4486	Long Column
11.5	117.3	718	4104	Long Column
12.0	122.4	659	3769	Long Column
12.5	127.5	607	3474	Long Column
13.0	132.6	562	3212	Long Column
13.5	137.7	521	2978	Long Column
14.0	142.8	484	2769	Long Column
14.5	147.9	451	2581	Long Column
15.0	153.0	422	2412	Long Column
15.5	158.1	395	2259	Long Column
16.0	163.2	371	2120	Long Column
16.5	168.3	349	1994	Long Column
17.0	173.4	328	1878	Long Column
17.5	178.5	310	1772	Long Column
18.0	183.5	293	1675	Long Column
18.5	188.6	277	1586	Long Column
19.0	193.7	263	1503	Long Column
19.5	198.8	250	1427	Long Column
20.0	203.9	237	1357	Long Column

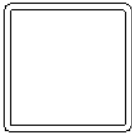

**PulTex Standard Structural Profiles
Square Tubes**

2" x 2" x 1/4" (Part# TQ 240)
PulTex 1500/1525/1625 Series
A = 1.73 in², r = .72in
Allowable Axial Stresses and Loads

Effective Column Length (KL) (ft.)	KL/r	Fa (psi)	Pa (lbs.)	
1.0	16.7	10000	17290	Short Column
1.5	25.1	10000	17290	Short Column
2.0	33.4	8833	15273	Long Column
2.5	41.8	5653	9775	Long Column
3.0	50.1	3926	6788	Long Column
3.5	58.5	2884	4987	Long Column
4.0	66.9	2208	3818	Long Column
4.5	75.2	1745	3017	Long Column
5.0	83.6	1413	2444	Long Column
5.5	91.9	1168	2020	Long Column
6.0	100.3	981	1697	Long Column
6.5	108.6	836	1446	Long Column
7.0	117.0	721	1247	Long Column
7.5	125.3	628	1086	Long Column
8.0	133.7	552	955	Long Column
8.5	142.1	489	846	Long Column
9.0	150.4	436	754	Long Column
9.5	158.8	392	677	Long Column
10.0	167.1	353	611	Long Column
10.5	175.5	320	554	Long Column
11.0	183.8	292	505	Long Column
11.5	192.2	267	462	Long Column
12.0	200.6	245	424	Long Column

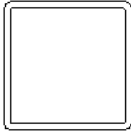

**PulTex Standard Structural Profiles
Square Tubes**

2-1/2" x 2-1/2" x 1/4" (Part# TQ 242)
PulTex 1500/1525/1625 Series
A = 2.24 in², r = .92 in
Allowable Axial Stresses and Loads

Effective Column Length (KL) (ft.)	KL/r	Fa (psi)	Pa (lbs.)	
1.0	13.0	10000	22400	Short Column
1.5	19.5	10000	22400	Short Column
2.0	26.0	10000	22400	Short Column
2.5	32.5	9322	20882	Long Column
3.0	39.0	6474	14501	Long Column
3.5	45.6	4756	10654	Long Column
4.0	52.1	3642	8157	Long Column
4.5	58.6	2877	6445	Long Column
5.0	65.1	2331	5220	Long Column
5.5	71.6	1926	4314	Long Column
6.0	78.1	1618	3625	Long Column
6.5	84.6	1379	3089	Long Column
7.0	91.1	1189	2664	Long Column
7.5	97.6	1036	2320	Long Column
8.0	104.1	910	2039	Long Column
8.5	110.6	806	1806	Long Column
9.0	117.1	719	1611	Long Column
9.5	123.6	646	1446	Long Column
10.0	130.2	583	1305	Long Column
10.5	136.7	528	1184	Long Column
11.0	143.2	482	1079	Long Column
11.5	149.7	441	987	Long Column
12.0	156.2	405	906	Long Column

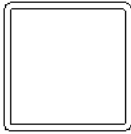

**PulTex Standard Structural Profiles
Square Tubes**

2.47" x 2.47" x 0.220" (Part# TQ 247)
PulTex 1500/1525/1625 Series
A = 1.97 in², r = .92 in
Allowable Axial Stresses and Loads

Effective Column Length (KL) (ft.)	KL/r	Fa (psi)	Pa (lbs.)	
1.0	13.0	10000	19700	Short Column
1.5	19.5	10000	19700	Short Column
2.0	26.1	10000	19700	Short Column
2.5	32.6	9302	18325	Long Column
3.0	39.1	6460	12726	Long Column
3.5	45.6	4746	9350	Long Column
4.0	52.1	3634	7158	Long Column
4.5	58.6	2871	5656	Long Column
5.0	65.1	2326	4581	Long Column
5.5	71.7	1922	3786	Long Column
6.0	78.2	1615	3181	Long Column
6.5	84.7	1376	2711	Long Column
7.0	91.2	1186	2337	Long Column
7.5	97.7	1034	2036	Long Column
8.0	104.2	908	1790	Long Column
8.5	110.7	805	1585	Long Column
9.0	117.3	718	1414	Long Column
9.5	123.8	644	1269	Long Column
10.0	130.3	581	1145	Long Column
10.5	136.8	527	1039	Long Column
11.0	143.3	480	947	Long Column
11.5	149.8	440	866	Long Column
12.0	156.4	404	795	Long Column

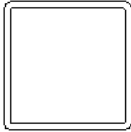

PulTex Standard Structural Profiles
Square Tubes

3" x 3" x 1/4" (Part# TQ 340) PulTex 1500/1525/1625 Series A = 2.74 in², r = 1.12 in Allowable Axial Stresses and Loads				
Effective Column Length (KL) (ft.)	KL/r	Fa (psi)	Pa (lbs.)	
1.0	10.7	10000	27400	Short Column
1.5	16.0	10000	27400	Short Column
2.0	21.3	10000	27400	Short Column
2.5	26.7	10000	27400	Short Column
3.0	32.0	9638	26409	Long Column
3.5	37.3	7081	19403	Long Column
4.0	42.7	5422	14855	Long Column
4.5	48.0	4284	11737	Long Column
5.0	53.3	3470	9507	Long Column
5.5	58.7	2868	7857	Long Column
6.0	64.0	2410	6602	Long Column
6.5	69.3	2053	5626	Long Column
7.0	74.7	1770	4851	Long Column
7.5	80.0	1542	4225	Long Column
8.0	85.3	1355	3714	Long Column
8.5	90.7	1201	3290	Long Column
9.0	96.0	1071	2934	Long Column
9.5	101.3	961	2634	Long Column
10.0	106.7	867	2377	Long Column
10.5	112.0	787	2156	Long Column
11.0	117.3	717	1964	Long Column
11.5	122.7	656	1797	Long Column
12.0	128.0	602	1651	Long Column
13.0	138.7	513	1406	Long Column
14.0	149.3	443	1213	Long Column
15.0	160.0	386	1056	Long Column
16.0	170.7	339	928	Long Column
17.0	181.3	300	822	Long Column
18.0	192.0	268	734	Long Column
19.0	202.7	240	658	Long Column
20.0	213.3	217	594	Long Column

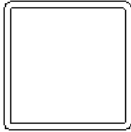

PulTex Standard Structural Profiles
Square Tubes

3-1/2" x 3-1/2" x 3/8" (Part# TQ 360) PulTex 1500/1525/1625 Series A = 4.68 in², r = 1.28 in³ Allowable Axial Stresses and Loads				
Effective Column Length (KL) (ft.)	KL/r	Fa (psi)	Pa (lbs.)	
1.0	9.3	10000	46770	Short Column
1.5	14.0	10000	46770	Short Column
2.0	18.7	10000	46770	Short Column
2.5	23.4	10000	46770	Short Column
3.0	28.0	10000	46770	Short Column
3.5	32.7	9224	43142	Long Column
4.0	37.4	7062	33031	Long Column
4.5	42.1	5580	26098	Long Column
5.0	46.7	4520	21140	Long Column
5.5	51.4	3735	17471	Long Column
6.0	56.1	3139	14680	Long Column
6.5	60.7	2675	12509	Long Column
7.0	65.4	2306	10786	Long Column
7.5	70.1	2009	9395	Long Column
8.0	74.8	1766	8258	Long Column
8.5	79.4	1564	7315	Long Column
9.0	84.1	1395	6525	Long Column
9.5	88.8	1252	5856	Long Column
10.0	93.5	1130	5285	Long Column
10.5	98.1	1025	4794	Long Column
11.0	102.8	934	4368	Long Column
11.5	107.5	854	3996	Long Column
12.0	112.1	785	3670	Long Column
13.0	121.5	669	3127	Long Column
14.0	130.8	577	2696	Long Column
15.0	140.2	502	2349	Long Column
16.0	149.5	441	2064	Long Column
17.0	158.9	391	1829	Long Column
18.0	168.2	349	1631	Long Column
19.0	177.6	313	1464	Long Column
20.0	186.9	282	1321	Long Column

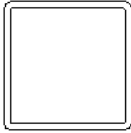

**PulTex Standard Structural Profiles
Square Tubes**

4" x 4" x 1/4" (Part# TQ 440) PulTex 1500/1525/1625 Series A = 3.73 in², r = 1.53 in Allowable Axial Stresses and Loads				
Effective Column Length (KL) (ft.)	KL/r	Fa (psi)	Pa (lbs.)	
1.0	7.8	10000	37300	Short Column
1.5	11.8	10000	37300	Short Column
2.0	15.7	10000	37300	Short Column
2.5	19.6	10000	37300	Short Column
3.0	23.5	10000	37300	Short Column
3.5	27.5	10000	37300	Short Column
4.0	31.4	10000	37300	Short Column
4.5	35.3	7923	29553	Long Column
5.0	39.2	6418	23938	Long Column
5.5	43.1	5304	19784	Long Column
6.0	47.1	4457	16624	Long Column
6.5	51.0	3797	14165	Long Column
7.0	54.9	3274	12213	Long Column
7.5	58.8	2852	10639	Long Column
8.0	62.7	2507	9351	Long Column
8.5	66.7	2221	8283	Long Column
9.0	70.6	1981	7388	Long Column
9.5	74.5	1778	6631	Long Column
10.0	78.4	1604	5985	Long Column
10.5	82.4	1455	5428	Long Column
11.0	86.3	1326	4946	Long Column
11.5	90.2	1213	4525	Long Column
12.0	94.1	1114	4156	Long Column
13.0	102.0	949	3541	Long Column
14.0	109.8	819	3053	Long Column
15.0	117.6	713	2660	Long Column
16.0	125.5	627	2338	Long Column
17.0	133.3	555	2071	Long Column
18.0	141.2	495	1847	Long Column
19.0	149.0	444	1658	Long Column
20.0	156.9	401	1496	Long Column

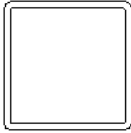

**PulTex Standard Structural Profiles
Square Tubes**

6" x 6" x 3/8" (Part# TQ 660)
PulTex 1500/1525/1625 Series
A = 8.48 in², r = 2.3 in
Allowable Axial Stresses and Loads

Effective Column Length (KL) (ft.)	KL/r	Fa (psi)	Pa (lbs.)	
1.0	5.2	10000	84800	Short Column
2.0	10.4	10000	84800	Short Column
3.0	15.7	10000	84800	Short Column
4.0	20.9	10000	84800	Short Column
5.0	26.1	10000	84800	Short Column
6.0	31.3	10000	84800	Short Column
7.0	36.5	7399	62747	Long Column
8.0	41.7	5665	48041	Long Column
9.0	47.0	4476	37958	Long Column
10.0	52.2	3626	30746	Long Column
11.0	57.4	2996	25410	Long Column
12.0	62.6	2518	21351	Long Column
13.0	67.8	2145	18193	Long Column
14.0	73.0	1850	15687	Long Column
15.0	78.3	1611	13665	Long Column
16.0	83.5	1416	12010	Long Column
17.0	88.7	1255	10639	Long Column
18.0	93.9	1119	9490	Long Column
19.0	99.1	1004	8517	Long Column
20.0	104.3	906	7687	Long Column
22.0	114.8	749	6353	Long Column
24.0	125.2	629	5338	Long Column

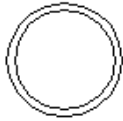

**PulTex Standard Structural Profiles
Round Tubes**

1-3/4" x 1/4" (Part# TU 142)
PulTex 1500/1525/1625 Series
A = 1.18 in², r = .54 in
Allowable Axial Stresses and Loads

Effective Column Length (KL) (ft.)	KL/r	Fa (psi)	Pa (lbs.)	
1.0	22.3	8937	10546	Short Column
1.5	33.5	8406	9919	Short Column
2.0	44.6	4952	5844	Long Column
2.5	55.8	3169	3740	Long Column
3.0	67.0	2201	2597	Long Column
3.5	78.1	1617	1908	Long Column
4.0	89.3	1238	1461	Long Column
4.5	100.4	978	1154	Long Column
5.0	111.6	792	935	Long Column
5.5	122.8	655	773	Long Column
6.0	133.9	550	649	Long Column
6.5	145.1	469	553	Long Column
7.0	156.3	404	477	Long Column
7.5	167.4	352	416	Long Column
8.0	178.6	310	365	Long Column

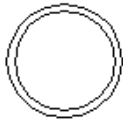

**PulTex Standard Structural Profiles
Round Tubes**

2" x 1/4" (Part# TU 240)
PulTex 1500/1525/1625 Series
A = 1.37 in², r = .62 in
Allowable Axial Stresses and Loads

Effective Column Length (KL) (ft.)	KL/r	Fa (psi)	Pa (lbs.)	
1.0	19.2	9086	12487	Short Column
1.5	28.8	8629	11859	Short Column
2.0	38.4	6693	9199	Long Column
2.5	48.0	4284	5888	Long Column
3.0	57.6	2975	4089	Long Column
3.5	67.2	2186	3004	Long Column
4.0	76.8	1673	2300	Long Column
4.5	86.4	1322	1817	Long Column
5.0	96.0	1071	1472	Long Column
5.5	105.6	885	1216	Long Column
6.0	115.2	744	1022	Long Column
6.5	124.8	634	871	Long Column
7.0	134.4	546	751	Long Column
7.5	144.0	476	654	Long Column
8.0	153.6	418	575	Long Column
8.5	163.2	371	509	Long Column
9.0	172.8	331	454	Long Column
9.5	182.4	297	408	Long Column
10.0	192.0	268	368	Long Column

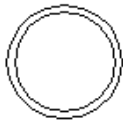

**PulTex Standard Structural Profiles
Round Tubes**

2-1/2" x 1/4" (Part# TU 242)
PulTex 1500/1525/1625 Series
A = 1.77 in², r = .80 in
Allowable Axial Stresses and Loads

Effective Column Length (KL) (ft.)	KL/r	Fa (psi)	Pa (lbs.)	
1.0	15.0	9286	16408	Short Column
1.5	22.5	8929	15777	Short Column
2.0	30.0	8571	15146	Short Column
2.5	37.5	7018	12402	Long Column
3.0	45.0	4874	8612	Long Column
3.5	52.5	3581	6327	Long Column
4.0	60.0	2742	4844	Long Column
4.5	67.5	2166	3828	Long Column
5.0	75.0	1755	3100	Long Column
5.5	82.5	1450	2562	Long Column
6.0	90.0	1218	2153	Long Column
6.5	97.5	1038	1835	Long Column
7.0	105.0	895	1582	Long Column
7.5	112.5	780	1378	Long Column
8.0	120.0	685	1211	Long Column
8.5	127.5	607	1073	Long Column
9.0	135.0	542	957	Long Column
9.5	142.5	486	859	Long Column
10.0	150.0	439	775	Long Column
10.5	157.5	398	703	Long Column
11.0	165.0	363	641	Long Column
11.5	172.5	332	586	Long Column
12.0	180.0	305	538	Long Column

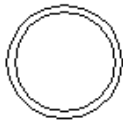

**PulTex Standard Structural Profiles
Round Tubes**

3" x 1/8" (Part# TU 320)
PulTex 1500/1525/1625 Series
A = 1.125 in², r = 1.017 in
Allowable Axial Stresses and Loads

Effective Column Length (KL) (ft.)	KL/r	Fa (psi)	Pa (lbs.)	
1.0	11.8	9438	10618	Short Column
1.5	17.7	9157	10302	Short Column
2.0	23.6	8876	9986	Short Column
2.5	29.5	8595	9670	Short Column
3.0	35.4	7877	8861	Long Column
3.5	41.3	5787	6510	Long Column
4.0	47.2	4431	4984	Long Column
4.5	53.1	3501	3938	Long Column
5.0	59.0	2836	3190	Long Column
5.5	64.9	2343	2636	Long Column
6.0	70.8	1969	2215	Long Column
6.5	76.7	1678	1888	Long Column
7.0	82.6	1447	1628	Long Column
7.5	88.5	1260	1418	Long Column
8.0	94.4	1108	1246	Long Column
8.5	100.3	981	1104	Long Column
9.0	106.2	875	985	Long Column
9.5	112.1	785	884	Long Column
10.0	118.0	709	798	Long Column
10.5	123.9	643	723	Long Column
11.0	129.8	586	659	Long Column
11.5	135.7	536	603	Long Column
12.0	141.6	492	554	Long Column
13.0	153.4	419	472	Long Column
14.0	165.2	362	407	Long Column
15.0	177.0	315	354	Long Column
16.0	188.8	277	312	Long Column

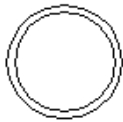

**PulTex Standard Structural Profiles
Round Tubes**

3" x 1/4" (Part# TU 340)
PulTex 1500/1525/1625 Series
A = 2.16 in², r = .98 in
Allowable Axial Stresses and Loads

Effective Column Length (KL) (ft.)	KL/r	Fa (psi)	Pa (lbs.)	
1.0	12.3	9415	20334	Short Column
1.5	18.4	9122	19702	Short Column
2.0	24.6	8829	19070	Short Column
2.5	30.7	8537	18438	Short Column
3.0	36.9	7259	15678	Long Column
3.5	43.0	5333	11518	Long Column
4.0	49.2	4083	8819	Long Column
4.5	55.3	3226	6968	Long Column
5.0	61.5	2613	5644	Long Column
5.5	67.6	2160	4664	Long Column
6.0	73.7	1815	3919	Long Column
6.5	79.9	1546	3340	Long Column
7.0	86.0	1333	2880	Long Column
7.5	92.2	1161	2508	Long Column
8.0	98.3	1021	2205	Long Column
8.5	104.5	904	1953	Long Column
9.0	110.6	807	1742	Long Column
9.5	116.8	724	1563	Long Column
10.0	122.9	653	1411	Long Column
10.5	129.1	593	1280	Long Column
11.0	135.2	540	1166	Long Column
11.5	141.3	494	1067	Long Column
12.0	147.5	454	980	Long Column
13.0	159.8	387	835	Long Column
14.0	172.1	333	720	Long Column
15.0	184.4	290	627	Long Column
16.0	196.7	255	551	Long Column

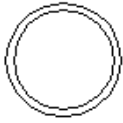

**PulTex Standard Structural Profiles
Round Tubes**

3-1/2" x 1/4" (Part# TU 342)
PulTex 1500/1525/1625 Series
A = 2.84 in², r = 1.14 in
Allowable Axial Stresses and Loads

Effective Column Length (KL) (ft.)	KL/r	Fa (psi)	Pa (lbs.)	
1.0	10.5	9500	26996	Short Column
1.5	15.8	9250	26285	Short Column
2.0	21.0	9000	25574	Short Column
2.5	26.3	8749	24863	Short Column
3.0	31.5	8499	24153	Short Column
3.5	36.8	7302	20750	Long Column
4.0	42.0	5591	15887	Long Column
4.5	47.3	4417	12552	Long Column
5.0	52.5	3578	10167	Long Column
5.5	57.8	2957	8403	Long Column
6.0	63.0	2485	7061	Long Column
6.5	68.3	2117	6016	Long Column
7.0	73.5	1825	5187	Long Column
7.5	78.8	1590	4519	Long Column
8.0	84.0	1398	3972	Long Column
8.5	89.3	1238	3518	Long Column
9.0	94.5	1104	3138	Long Column
9.5	99.8	991	2816	Long Column
10.0	105.0	894	2542	Long Column
10.5	110.3	811	2306	Long Column
11.0	115.5	739	2101	Long Column
11.5	120.8	676	1922	Long Column
12.0	126.1	621	1765	Long Column
13.0	136.6	529	1504	Long Column
14.0	147.1	456	1297	Long Column
15.0	157.6	398	1130	Long Column
16.0	168.1	349	993	Long Column

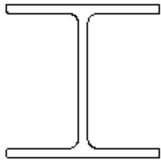

**PulTex Standard Structural Profiles
Wide Flange Sections**

3" x 3" x 1/4" (Part# IW 340) PulTex 1500/1525/1625 Series A = 2.17 in², r = .71 in Allowable Axial Stresses and Loads				
Effective Column Length (KL) (ft.)	KL/r	Fa (psi)	Pa (lbs.)	
1.0	16.9	10499	22783	Short Column
1.5	25.4	10499	22783	Short Column
2.0	33.8	8638	18744	Long Column
2.5	42.3	5528	11996	Long Column
3.0	50.7	3839	8331	Long Column
3.5	59.2	2820	6120	Long Column
4.0	67.6	2159	4686	Long Column
4.5	76.1	1706	3702	Long Column
5.0	84.5	1382	2999	Long Column
5.5	93.0	1142	2479	Long Column
6.0	101.4	960	2083	Long Column
6.5	109.9	818	1775	Long Column
7.0	118.3	705	1530	Long Column
7.5	126.8	614	1333	Long Column
8.0	135.2	540	1171	Long Column
8.5	143.7	478	1038	Long Column
9.0	152.1	427	926	Long Column
9.5	160.6	383	831	Long Column
10.0	169.0	346	750	Long Column
11.0	185.9	286	620	Long Column
12.0	202.8	240	521	Long Column

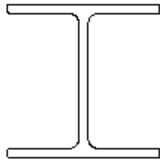

**PulTex Standard Structural Profiles
Wide Flange Sections**

4" x 4" x 1/4" (Part# IW 440)				
PulTex 1500/1525/1625 Series				
A = 2.92 in², r = .95 in				
Allowable Axial Stresses and Loads				
Effective Column Length (KL) (ft.)	KL/r	Fa (psi)	Pa (lbs.)	
1.0	12.6	5906	17245	Short Column
1.5	18.9	5906	17245	Short Column
2.0	25.3	5906	17245	Short Column
2.5	31.6	5906	17245	Short Column
3.0	37.9	5906	17245	Short Column
3.5	44.2	5050	14745	Long Column
4.0	50.5	3866	11289	Long Column
4.5	56.8	3055	8920	Long Column
5.0	63.2	2474	7225	Long Column
5.5	69.5	2045	5971	Long Column
6.0	75.8	1718	5017	Long Column
6.5	82.1	1464	4275	Long Column
7.0	88.4	1262	3686	Long Column
7.5	94.7	1100	3211	Long Column
8.0	101.1	967	2822	Long Column
8.5	107.4	856	2500	Long Column
9.0	113.7	764	2230	Long Column
9.5	120.0	685	2001	Long Column
10.0	126.3	619	1806	Long Column
11.0	138.9	511	1493	Long Column
12.0	151.6	430	1254	Long Column

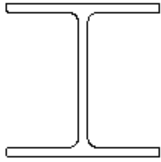

**PulTex Standard Structural Profiles
Wide Flange Sections**

6" x 6" x 1/4" (Part# IW 640) PulTex 1500/1525/1625 Series A = 4.42 in², r = 1.42 in Allowable Axial Stresses and Loads				
Effective Column Length (KL) (ft.)	KL/r	Fa (psi)	Pa (lbs.)	
1.0	8.5	2625	11602	Short Column
1.5	12.7	2625	11602	Short Column
2.0	16.9	2625	11602	Short Column
2.5	21.1	2625	11602	Short Column
3.0	25.4	2625	11602	Short Column
3.5	29.6	2625	11602	Short Column
4.0	33.8	2625	11602	Short Column
4.5	38.0	2625	11602	Short Column
5.0	42.3	2625	11602	Short Column
5.5	46.5	2625	11602	Short Column
6.0	50.7	2625	11602	Short Column
6.5	54.9	2625	11602	Short Column
7.0	59.2	2625	11602	Short Column
7.5	63.4	2457	10860	Long Column
8.0	67.6	2159	9545	Long Column
8.5	71.8	1913	8455	Long Column
9.0	76.1	1706	7541	Long Column
9.5	80.3	1531	6768	Long Column
10.0	84.5	1382	6109	Long Column
11.0	93.0	1142	5048	Long Column
12.0	101.4	960	4242	Long Column
13.0	109.9	818	3615	Long Column
14.0	118.3	705	3117	Long Column
15.0	126.8	614	2715	Long Column
16.0	135.2	540	2386	Long Column
17.0	143.7	478	2114	Long Column
18.0	152.1	427	1885	Long Column
19.0	160.6	383	1692	Long Column
20.0	169.0	346	1527	Long Column

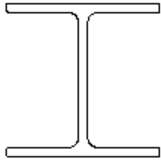

**PulTex Standard Structural Profiles
Wide Flange Sections**

6" x 6" x 3/8" (Part# IW 660) PulTex 1500/1525/1625 Series A = 6.56 in², r = 1.42 in Allowable Axial Stresses and Loads				
Effective Column Length (KL) (ft.)	KL/r	Fa (psi)	Pa (lbs.)	
1.0	8.5	5906	38801	Short Column
1.5	12.7	5906	38801	Short Column
2.0	16.9	5906	38801	Short Column
2.5	21.1	5906	38801	Short Column
3.0	25.4	5906	38801	Short Column
3.5	29.6	5906	38801	Short Column
4.0	33.8	5906	38801	Short Column
4.5	38.0	5906	38801	Short Column
5.0	42.3	5528	36320	Long Column
5.5	46.5	4569	30016	Long Column
6.0	50.7	3839	25222	Long Column
6.5	54.9	3271	21491	Long Column
7.0	59.2	2820	18530	Long Column
7.5	63.4	2457	16142	Long Column
8.0	67.6	2159	14187	Long Column
8.5	71.8	1913	12567	Long Column
9.0	76.1	1706	11210	Long Column
9.5	80.3	1531	10061	Long Column
10.0	84.5	1382	9080	Long Column
11.0	93.0	1142	7504	Long Column
12.0	101.4	960	6305	Long Column
13.0	109.9	818	5373	Long Column
14.0	118.3	705	4633	Long Column
15.0	126.8	614	4036	Long Column
16.0	135.2	540	3547	Long Column
17.0	143.7	478	3142	Long Column
18.0	152.1	427	2802	Long Column
19.0	160.6	383	2515	Long Column
20.0	169.0	346	2270	Long Column

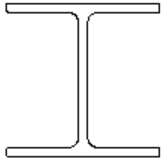

**PulTex Standard Structural Profiles
Wide Flange Sections**

8" x 8" x 3/8" (Part# IW 860) PulTex 1500/1525/1625 Series A = 8.82 in², r = 1.90 in Allowable Axial Stresses and Loads				
Effective Column Length (KL) (ft.)	KL/r	Fa (psi)	Pa (lbs.)	
1.0	6.3	3322	29300	Short Column
1.5	9.5	3322	29300	Short Column
2.0	12.6	3322	29300	Short Column
2.5	15.8	3322	29300	Short Column
3.0	18.9	3322	29300	Short Column
3.5	22.1	3322	29300	Short Column
4.0	25.3	3322	29300	Short Column
4.5	28.4	3322	29300	Short Column
5.0	31.6	3322	29300	Short Column
5.5	34.7	3322	29300	Short Column
6.0	37.9	3322	29300	Short Column
6.5	41.1	3322	29300	Short Column
7.0	44.2	3322	29300	Short Column
7.5	47.4	3322	29300	Short Column
8.0	50.5	3322	29300	Short Column
8.5	53.7	3322	29300	Short Column
9.0	56.8	3055	26942	Long Column
9.5	60.0	2742	24181	Long Column
10.0	63.2	2474	21823	Long Column
11.0	69.5	2045	18036	Long Column
12.0	75.8	1718	15155	Long Column
13.0	82.1	1464	12913	Long Column
14.0	88.4	1262	11134	Long Column
15.0	94.7	1100	9699	Long Column
16.0	101.1	967	8525	Long Column
17.0	107.4	856	7551	Long Column
18.0	113.7	764	6736	Long Column
19.0	120.0	685	6045	Long Column
20.0	126.3	619	5456	Long Column
21.0	132.6	561	4949	Long Column
22.0	138.9	511	4509	Long Column

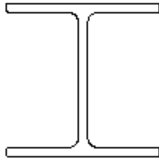

**PulTex Standard Structural Profiles
Wide Flange Sections**

8" x 8" x 1/2" (Part# IW 880) PulTex 1500/1525/1625 Series A = 11.67 in², r = 1.90 in Allowable Axial Stresses and Loads				
Effective Column Length (KL) (ft.)	KL/r	Fa (psi)	Pa (lbs.)	
1.0	6.3	5906	68921	Short Column
1.5	9.5	5906	68921	Short Column
2.0	12.6	5906	68921	Short Column
2.5	15.8	5906	68921	Short Column
3.0	18.9	5906	68921	Short Column
3.5	22.1	5906	68921	Short Column
4.0	25.3	5906	68921	Short Column
4.5	28.4	5906	68921	Short Column
5.0	31.6	5906	68921	Short Column
5.5	34.7	5906	68921	Short Column
6.0	37.9	5906	68921	Short Column
6.5	41.1	5856	68342	Short Column
7.0	44.2	5050	58928	Long Column
7.5	47.4	4399	51333	Long Column
8.0	50.5	3866	45117	Long Column
8.5	53.7	3425	39965	Long Column
9.0	56.8	3055	35648	Long Column
9.5	60.0	2742	31994	Long Column
10.0	63.2	2474	28875	Long Column
11.0	69.5	2045	23863	Long Column
12.0	75.8	1718	20052	Long Column
13.0	82.1	1464	17086	Long Column
14.0	88.4	1262	14732	Long Column
15.0	94.7	1100	12833	Long Column
16.0	101.1	967	11279	Long Column
17.0	107.4	856	9991	Long Column
18.0	113.7	764	8912	Long Column
19.0	120.0	685	7999	Long Column
20.0	126.3	619	7219	Long Column
21.0	132.6	561	6548	Long Column
22.0	138.9	511	5966	Long Column

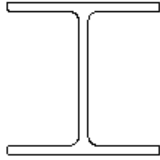

**PulTex Standard Structural Profiles
Wide Flange Sections**

10" x 10" x 3/8" (Part# IW 960) PulTex 1500/1525/1625 Series A = 11.07 in², r = 2.37 in Allowable Axial Stresses and Loads				
Effective Column Length (KL) (ft.)	KL/r	Fa (psi)	Pa (lbs.)	
1.0	5.1	2126	23536	Short Column
1.5	7.6	2126	23536	Short Column
2.0	10.1	2126	23536	Short Column
2.5	12.7	2126	23536	Short Column
3.0	15.2	2126	23536	Short Column
3.5	17.7	2126	23536	Short Column
4.0	20.3	2126	23536	Short Column
4.5	22.8	2126	23536	Short Column
5.0	25.3	2126	23536	Short Column
5.5	27.8	2126	23536	Short Column
6.0	30.4	2126	23536	Short Column
6.5	32.9	2126	23536	Short Column
7.0	35.4	2126	23536	Short Column
7.5	38.0	2126	23536	Short Column
8.0	40.5	2126	23536	Short Column
8.5	43.0	2126	23536	Short Column
9.0	45.6	2126	23536	Short Column
9.5	48.1	2126	23536	Short Column
10.0	50.6	2126	23536	Short Column
11.0	55.7	2126	23536	Short Column
12.0	60.8	2126	23536	Short Column
13.0	65.8	2126	23536	Short Column
14.0	70.9	1964	21743	Long Column
15.0	75.9	1711	18941	Long Column
16.0	81.0	1504	16647	Long Column
17.0	86.1	1332	14746	Long Column
18.0	91.1	1188	13153	Long Column
19.0	96.2	1066	11805	Long Column
20.0	101.3	962	10654	Long Column
21.0	106.3	873	9664	Long Column
22.0	111.4	795	8805	Long Column
23.0	116.5	728	8056	Long Column
24.0	121.5	668	7399	Long Column
25.0	126.6	616	6819	Long Column

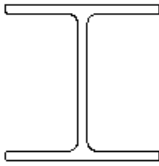

**PulTex Standard Structural Profiles
Wide Flange Sections**

10" x 10" x 1/2" (Part# IW 980)
PulTex 1500/1525/1625 Series
A = 14.67 in², r = 2.37 in
Allowable Axial Stresses and Loads

Effective Column Length (KL) (ft.)	KL/r	Fa (psi)	Pa (lbs.)	
1.0	5.1	3780	55448	Short Column
1.5	7.6	3780	55448	Short Column
2.0	10.1	3780	55448	Short Column
2.5	12.7	3780	55448	Short Column
3.0	15.2	3780	55448	Short Column
3.5	17.7	3780	55448	Short Column
4.0	20.3	3780	55448	Short Column
4.5	22.8	3780	55448	Short Column
5.0	25.3	3780	55448	Short Column
5.5	27.8	3780	55448	Short Column
6.0	30.4	3780	55448	Short Column
6.5	32.9	3780	55448	Short Column
7.0	35.4	3780	55448	Short Column
7.5	38.0	3780	55448	Short Column
8.0	40.5	3780	55448	Short Column
8.5	43.0	3780	55448	Short Column
9.0	45.6	3780	55448	Short Column
9.5	48.1	3780	55448	Short Column
10.0	50.6	3780	55448	Short Column
11.0	55.7	3182	46675	Long Column
12.0	60.8	2673	39220	Long Column
13.0	65.8	2278	33418	Long Column
14.0	70.9	1964	28814	Long Column
15.0	75.9	1711	25101	Long Column
16.0	81.0	1504	22061	Long Column
17.0	86.1	1332	19542	Long Column
18.0	91.1	1188	17431	Long Column
19.0	96.2	1066	15644	Long Column
20.0	101.3	962	14119	Long Column
21.0	106.3	873	12806	Long Column
22.0	111.4	795	11669	Long Column
23.0	116.5	728	10676	Long Column
24.0	121.5	668	9805	Long Column
25.0	126.6	616	9036	Long Column

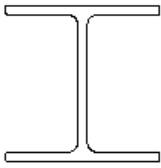

**PulTex Standard Structural Profiles
Wide Flange Sections**

12" x 12" x 1/2" (Part# IW 982) PulTex 1500/1525/1625 Series A = 17.67 in², r = 2.84 in Allowable Axial Stresses and Loads				
Effective Column Length (KL) (ft.)	KL/r	Fa (psi)	Pa (lbs.)	
1.0	4.2	2625	46380	Short Column
1.5	6.3	2625	46380	Short Column
2.0	8.5	2625	46380	Short Column
2.5	10.6	2625	46380	Short Column
3.0	12.7	2625	46380	Short Column
3.5	14.8	2625	46380	Short Column
4.0	16.9	2625	46380	Short Column
4.5	19.0	2625	46380	Short Column
5.0	21.1	2625	46380	Short Column
5.5	23.2	2625	46380	Short Column
6.0	25.4	2625	46380	Short Column
6.5	27.5	2625	46380	Short Column
7.0	29.6	2625	46380	Short Column
7.5	31.7	2625	46380	Short Column
8.0	33.8	2625	46380	Short Column
8.5	35.9	2625	46380	Short Column
9.0	38.0	2625	46380	Short Column
9.5	40.1	2625	46380	Short Column
10.0	42.3	2625	46380	Short Column
11.0	46.5	2625	46380	Short Column
12.0	50.7	2625	46380	Short Column
13.0	54.9	2625	46380	Short Column
14.0	59.2	2625	46380	Short Column
15.0	63.4	2457	43414	Long Column
16.0	67.6	2159	38157	Long Column
17.0	71.8	1913	33800	Long Column
18.0	76.1	1706	30149	Long Column
19.0	80.3	1531	27059	Long Column
20.0	84.5	1382	24420	Long Column
21.0	88.7	1254	22150	Long Column
22.0	93.0	1142	20182	Long Column
23.0	97.2	1045	18465	Long Column
24.0	101.4	960	16959	Long Column
25.0	105.6	884	15629	Long Column

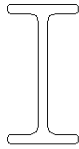

**PulTex Standard Structural Profiles
I-Sections**

3" x 1-1/2" x 1/4" (Part# IB 340)
PulTex 1500/1525/1625 Series
A = 1.42 in², r = .31 in
Allowable Axial Stresses and Loads

Effective Column Length (KL) (ft.)	KL/r	Fa (psi)	Pa (lbs.)	
1.0	38.2	6657	9439	Short Column
1.5	57.3	3003	4258	Long Column
2.0	76.4	1689	2395	Long Column
2.5	95.5	1081	1533	Long Column
3.0	114.6	751	1065	Long Column
3.5	133.8	552	782	Long Column
4.0	152.9	422	599	Long Column
4.5	172.0	334	473	Long Column

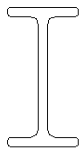

**PulTex Standard Structural Profiles
I-Sections**

4" x 2" x 1/4" (Part# IB 440)
PulTex 1500/1525/1625 Series
A = 1.92 in², r = .41 in
Allowable Axial Stresses and Loads

Effective Column Length (KL) (ft.)	KL/r	Fa (psi)	Pa (lbs.)	
1.0	29.0	7063	13561	Short Column
1.5	43.4	5229	10039	Long Column
2.0	57.9	2941	5647	Long Column
2.5	72.4	1882	3614	Long Column
3.0	86.9	1307	2510	Long Column
3.5	101.4	960	1844	Long Column
4.0	115.9	735	1412	Long Column
4.5	130.3	581	1115	Long Column
5.0	144.8	471	904	Long Column
5.5	159.3	389	747	Long Column
6.0	173.8	327	627	Long Column
6.5	188.3	76	146	Long Column

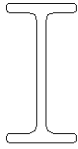

PulTex Standard Structural Profiles
I-Sections

6" x 3" x 1/4" (Part# IB 640) PulTex 1500/1525/1625 Series A = 2.92 in², r = .62 in Allowable Axial Stresses and Loads				
Effective Column Length (KL) (ft.)	KL/r	Fa (psi)	Pa (lbs.)	
1.0	19.5	7480	21825	Short Column
1.5	29.2	7053	20580	Short Column
2.0	38.9	6519	19021	Long Column
2.5	48.6	4172	12173	Long Column
3.0	58.4	2897	8454	Long Column
3.5	68.1	2129	6211	Long Column
4.0	77.8	1630	4755	Long Column
4.5	87.5	1288	3757	Long Column
5.0	97.3	1043	3043	Long Column
5.5	107.0	862	2515	Long Column
6.0	116.7	724	2113	Long Column
6.5	126.5	617	1801	Long Column
7.0	136.2	532	1553	Long Column
7.5	145.9	464	1353	Long Column
8.0	155.6	407	1189	Long Column
8.5	165.4	361	1053	Long Column
9.0	175.1	322	939	Long Column
9.5	184.8	227	662	Long Column

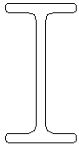

PulTex Standard Structural Profiles
I-Sections

6" x 3" x 3/8" (Part# IB 660) PulTex 1500/1525/1625 Series A = 4.31 in², r = .62 in Allowable Axial Stresses and Loads				
Effective Column Length (KL) (ft.)	KL/r	Fa (psi)	Pa (lbs.)	
1.0	19.3	7486	32304	Short Column
1.5	29.0	7063	30477	Short Column
2.0	38.6	6616	28550	Long Column
2.5	48.3	4234	18272	Long Column
3.0	57.9	2941	12689	Long Column
3.5	67.6	2160	9323	Long Column
4.0	77.2	1654	7138	Long Column
4.5	86.9	1307	5640	Long Column
5.0	96.6	1059	4568	Long Column
5.5	106.2	875	3775	Long Column
6.0	115.9	735	3172	Long Column
6.5	125.5	626	2703	Long Column
7.0	135.2	540	2331	Long Column
7.5	144.8	470	2030	Long Column
8.0	154.5	414	1784	Long Column
8.5	164.1	366	1581	Long Column
9.5	183.5	287	1238	Long Column

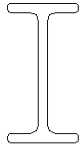

PulTex Standard Structural Profiles
I-Sections

8" x 4" x 3/8" (Part# IB 860) PulTex 1500/1525/1625 Series A = 5.81 in², r = .82 in Allowable Axial Stresses and Loads				
Effective Column Length (KL) (ft.)	KL/r	Fa (psi)	Pa (lbs.)	
1.0	14.6	7694	44744	Short Column
1.5	21.9	7375	42886	Short Column
2.0	29.1	7055	41028	Short Column
2.5	36.4	6736	39170	Short Column
3.0	43.7	5167	30046	Long Column
3.5	51.0	3796	22075	Long Column
4.0	58.3	2906	16901	Long Column
4.5	65.6	2296	13354	Long Column
5.0	72.8	1860	10817	Long Column
5.5	80.1	1537	8939	Long Column
6.0	87.4	1292	7512	Long Column
6.5	94.7	1101	6400	Long Column
7.0	102.0	949	5519	Long Column
7.5	109.3	827	4807	Long Column
8.0	116.5	727	4225	Long Column
8.5	123.8	644	3743	Long Column
9.0	131.1	574	3338	Long Column
9.5	138.4	515	2996	Long Column
10.0	145.7	465	2704	Long Column
10.5	153.0	422	2453	Long Column
11.0	160.3	384	2235	Long Column
11.5	167.5	352	2045	Long Column
12.5	182.1	298	1731	Long Column

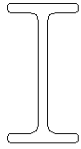

PulTex Standard Structural Profiles
I-Sections

8" x 4" x 1/2" (Part# IB 880) PulTex 1500/1525/1625 Series A = 7.67 in², r = .83 in Allowable Axial Stresses and Loads				
Effective Column Length (KL) (ft.)	KL/r	Fa (psi)	Pa (lbs.)	
1.0	14.5	7698	59053	Short Column
1.5	21.7	7380	56617	Short Column
2.0	29.0	7063	54180	Short Column
2.5	36.2	6745	51744	Short Column
3.0	43.5	5227	40100	Long Column
3.5	50.7	3841	29461	Long Column
4.0	57.9	2940	22556	Long Column
4.5	65.2	2323	17822	Long Column
5.0	72.4	1882	14436	Long Column
5.5	79.7	1555	11931	Long Column
6.0	86.9	1307	10025	Long Column
6.5	94.1	1114	8542	Long Column
7.0	101.4	960	7365	Long Column
7.5	108.6	836	6416	Long Column
8.0	115.9	735	5639	Long Column
8.5	123.1	651	4995	Long Column
9.0	130.4	581	4456	Long Column
9.5	137.6	521	3999	Long Column
10.0	144.8	470	3609	Long Column
11.0	159.3	389	2983	Long Column
12.0	173.8	327	2506	Long Column
13.0	188.3	75	575	Long Column

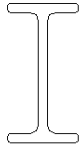

PulTex Standard Structural Profiles
I-Sections

10" x 5" x 3/8" (Part# IB 960) PulTex1500/1525/1625 Series A = 7.31 in², r = 1.03 in Allowable Axial Stresses and Loads				
Effective Column Length (KL) (ft.)	KL/r	Fa (psi)	Pa (lbs.)	
1.0	11.7	7821	57210	Short Column
1.5	17.5	7564	55335	Short Column
2.0	23.4	7308	53460	Short Column
2.5	29.2	7052	51585	Short Column
3.0	35.1	6796	49710	Short Column
3.5	40.9	5899	43151	Long Column
4.0	46.7	4516	33038	Long Column
4.5	52.6	3569	26104	Long Column
5.0	58.4	2890	21144	Long Column
5.5	64.3	2389	17475	Long Column
6.0	70.1	2007	14683	Long Column
6.5	76.0	1710	12511	Long Column
7.0	81.8	1475	10788	Long Column
7.5	87.7	1285	9397	Long Column
8.0	93.5	1129	8259	Long Column
8.5	99.3	1000	7316	Long Column
9.0	105.2	892	6526	Long Column
9.5	111.0	801	5857	Long Column
10.0	116.9	723	5286	Long Column
11.0	128.6	597	4369	Long Column
12.0	140.2	502	3671	Long Column
13.0	151.9	428	3128	Long Column
14.0	163.6	369	2697	Long Column
15.0	175.3	321	2349	Long Column
16.0	187.0	132	966	Long Column

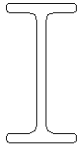

PulTex Standard Structural Profiles
I-Sections

10" x 5" x 1/2" (Part# IB 980) PulTex 1500/1525/1625 Series A = 9.67 in², r = 1.03 in Allowable Axial Stresses and Loads				
Effective Column Length (KL) (ft.)	KL/r	Fa (psi)	Pa (lbs.)	
1.0	11.6	7823	75655	Short Column
1.5	17.5	7567	73186	Short Column
2.0	23.3	7312	70716	Short Column
2.5	29.1	7057	68247	Short Column
3.0	34.9	6801	65778	Short Column
3.5	40.7	5944	57484	Long Column
4.0	46.6	4551	44011	Long Column
4.5	52.4	3596	34774	Long Column
5.0	58.2	2912	28167	Long Column
5.5	64.0	2407	23279	Long Column
6.0	69.9	2023	19561	Long Column
6.5	75.7	1723	16667	Long Column
7.0	81.5	1486	14371	Long Column
7.5	87.3	1294	12519	Long Column
8.0	93.1	1138	11003	Long Column
8.5	99.0	1008	9746	Long Column
9.0	104.8	899	8694	Long Column
9.5	110.6	807	7803	Long Column
10.0	116.4	728	7042	Long Column
11.0	128.1	602	5820	Long Column
12.0	139.7	506	4890	Long Column
13.0	151.4	431	4167	Long Column
14.0	163.0	371	3593	Long Column
15.0	174.6	324	3130	Long Column
16.0	186.3	163	1577	Long Column

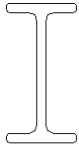

PulTex Standard Structural Profiles
I-Sections

12" x 6" x 1/2" (Part# IB 982) PulTex 1500/1525/1625 Series A = 11.67 in², r = 1.23 in Allowable Axial Stresses and Loads				
Effective Column Length (KL) (ft.)	KL/r	Fa (psi)	Pa (lbs.)	
1.0	9.7	7907	92280	Short Column
1.5	14.6	7693	89790	Short Column
2.0	19.5	7480	87300	Short Column
2.5	24.3	7267	84810	Short Column
3.0	29.2	7053	82320	Short Column
3.5	34.0	6840	79830	Short Column
4.0	38.9	6518	76070	Long Column
4.5	43.8	5150	60105	Long Column
5.0	48.6	4171	48685	Long Column
5.5	53.5	3447	40235	Long Column
6.0	58.4	2897	33809	Long Column
6.5	63.2	2468	28808	Long Column
7.0	68.1	2128	24839	Long Column
7.5	73.0	1854	21638	Long Column
8.0	77.8	1629	19017	Long Column
8.5	82.7	1443	16846	Long Column
9.0	87.6	1287	15026	Long Column
9.5	92.4	1156	13486	Long Column
10.0	97.3	1043	12171	Long Column
11.0	107.0	862	10059	Long Column
12.0	116.7	724	8452	Long Column
13.0	126.5	617	7202	Long Column
14.0	136.2	532	6210	Long Column
15.0	145.9	463	5409	Long Column
16.0	155.7	407	4754	Long Column
17.0	165.4	361	4211	Long Column
18.0	175.1	322	3757	Long Column
19.0	184.8	226	2641	Long Column

Biography

Dr. Robert Yuan

Dr. Robert Yuan has been a faculty member with the University of Texas at Arlington (UTA), Arlington, Texas, since 1970. He is a professor in the Department of Civil and Environmental Engineering and has been teaching courses in the area of structural design and analysis, structural mechanics, and structural materials. Dr. Robert L. Yuan received his Ph.D. degree in theoretical and applied mechanics from the University of Illinois in 1968, and his M.S. and B.S. degrees in Structural Engineering in 1964 and 1960, respectively. His research specialties include (1) properties and behavior of reinforced concrete and prestressed concrete; (2) fiber-reinforced polymer composites for civil engineering structure applications; and (3) experimental mechanics.

Dr. Yuan has published over 40 refereed papers and 60 technical reports. He has spoken at more than 50 national and international conferences. Dr. Yuan has supervised 19 master theses and 10 doctoral dissertations. He is the faculty advisor of the Chi Epsilon student chapter, a national honor society for civil engineers.

Dr. Yuan received the Outstanding Engineering Teacher Award in 1976, and the Haliburton Research in Excellence Award in 1986 at UTA.

Publications – Technical Papers

“The Effect of Environmental Exposure on the Behavior of Pultruded Mechanical Connections,” Proceedings of ICE '97, Vol. 1, pp. 14F1 – 14F6 (with Shane E. Weyant).

“Hydrothermal Effects on the Bearing Strength of FRP Composite Joints,” Proceedings of ASCE/MEC '96, Vol. 1, pp. 243-250 (with Stephanie Hurd).

“Study of Mechanical Connections for GFRP Laminated Structures,” Proceedings of ACMBS '96, Vol. 1, pp. 951-958 (with C.J. Lui and T. Daley).

“Vibration Analysis of GFRP Composite Box Beams,” Proceedings of ICCE '96, Vol. 1, pp. 965-966 (with S. Seangatith).

“Optimization of GFRP Composite Bridge Railing Systems,” Proceedings of Fourth National Bridge Research Conference, pp. 345-348, 1996 (with S. Seangatith).

“The Effects of End Support Conditions on the Behavior of GFRP Composite Columns,” Proceedings of ICCI '96, Vol. 1, pp. 621-627 (with Z. Hashcm).

Presentations at National & International Meetings

“The Effect of Environmental Exposure on the Behavior of Pultruded Mechanical Connections,” SPI/ICE Conference, Nashville, Tennessee, January 27, 1997.

“Hydrothermal Effects on the Bearing Strength of FRP Composite Joint,” ASCE/MEC Conference, Washington, D.C., November 11, 1996.

“Study of Mechanical Connection for GFRP Laminated Structures,” ACMBS Conference, Montreal, Canada, August 14, 1996.

Presentations at National & International Meetings (cont'd)

“Vibration Analysis of GFRP Composite Box Beams,” ICCE/3 Conference, New Orleans, Louisiana, July 23, 1996.

“Optimization of GFRP Composite Bridge Railing Systems,” Fourth National Bridge Research Conference, June 19, 1996.

Chapter 6 Environmental Considerations

Pultrusions are used in many varied applications. Through experience and laboratory testing, PulTex Profiles have been evaluated in a variety of environments. The resulting guidelines should be considered if the pultrusion is to be exposed to environmental attack.

Temperature

Pultrusion experiences some property loss from continuous exposure to high temperatures. It is, therefore, recommended that property loss be taken into consideration during design using the following guidelines for PulTex 1500/1525 Series and 1625 Series.

Table 6-1 Property Retention at Varying Temperatures

	Temperature	PulTex 1500/1525 Series	PulTex 1625 Series
Ultimate Stress	100° F	85%	90%
	125° F	70%	80%
	150° F	50%	80%
	175° F	Not Recommended	75%
	200° F	Not Recommended	50%
Modulus of Elasticity	100° F (37° C)	100%	100%
	125° F (51° C)	90%	95%
	150° F (65° C)	85%	90%
	175° F (79° C)	Not Recommended	88%
	200° F (93° C)	Not Recommended	85%

In applications requiring greater strength retention, it is possible to select a higher performance resin system specifically designed for elevated temperatures. An example is PulTex 1625 Series Vinyl Ester, which has better strength retention of properties at elevated temperatures. Creative Pultrusions can design additional resin systems to achieve higher temperature ratings. Contact Creative Pultrusions early in the design stages so that confirmation testing can be performed for various temperatures and environments to verify suitability.

Weathering

Most plastic materials undergo some decay and change in appearance during prolonged exposure to outdoor weathering. In order to minimize this effect with pultruded profiles, various options are available.

UV Stabilizers

PulTex 1500/1525 Series and 1600/1625 Series contain a UV inhibitor for protection against sunlight. It will retard the effect of outdoor weathering, but eventually the profile surface will degrade. A condition, “fiber blooming”, will occur on the surface of the profile with subsequent slight deterioration in physical properties.

Surfacing Veils

To enhance the weathering characteristics further, a synthetic veil is applied to the composite surface during processing. The veil enhances weatherability and corrosion resistance by adding resin thickness to the surface of the product. It provides a smooth glass-free surface, eliminating any possibility of exposing glass fiber.

Coatings

The optimum method of maintaining surface appearance during outdoor exposure is to apply a coating to the surface. Two-component, UV stabilized, urethane coatings work very well with this application. A 0.38 mm dry coating will provide protection for many years with minimal change in appearance. A coatings manufacturer should be contacted in order to determine the best coating for the application.

Resistance To Chemicals And Reagents

PulTex is resistant to a wide range of organic and inorganic substances. 1500/1525 Series is based on isophthalic polyester. 1600/1625 Series is based on vinyl ester.

Concentration Of Solution

The percentage of the reagent in the solution or environment will affect the overall performance of the pultruded profile.

Time Of Chemical Exposure

Time of chemical exposure must be identified whether the application involves intermittent exposures, exposure to fumes, complete submersion or only an occasional splash.

Chemical Compatibility Guide

The Chemical Compatibility Guide describes various resin series and presents a detailed chemical resistance guide to assist engineers in recommending the type of resin to be used in each application.

PulTex Selection Guide

PulTex 1500 Series Polyester Resin
PulTex 1525 Series Flame Retardant Polyester Resin
PulTex 1625 Series Flame Retardant Vinyl Ester Resin

Thermosetting resins are used in a wide range of fiberglass reinforced profiles. Conventional fabrication methods are used, coupled with sealing all cut holes and ends, to enhance the corrosion resistance.

The general guidelines in selection of resin types depend on the following:

- the corrosion environment
- normal operating concentration, including minimum and maximum concentration
- normal operating temperature, including minimum and maximum temperature

The Chemical Compatibility Guide provides up-to-date information regarding the chemical resistance for PulTex Profiles.

The data presented in the Chemical Compatibility Guide on the following pages covers the effect of chemicals on pultruded fiber reinforced profiles. This chart is provided as a guide only. Evaluate these recommendations in a laboratory or actual field trial prior to use.

Temperatures are not the minimum or maximum, but represent standard test conditions. Some products may be suitable at higher temperatures. Individual testing would be required. Contact Creative Pultrusions for chemicals, temperatures, or both, for any special application. Resin systems can be designed for special needs.

Chemical Compatibility Guide

Acetic Acid – Calcium Bisulfite

Chemical Environment	Concentration	Flowgrip®		Supergrate™ Pultruded Grating		Supergrate™ Molded Grating		PulTex Structural Profiles	
		Polyester	Vinyl ester	Polyester	Vinyl ester	Polyester	Vinyl ester	1500/1525 Srs.	1625 Srs.
		Temp	Temp	Temp	Temp	Temp	Temp	Temp	Temp
Max.	Max.	Max.	Max.	Max.	Max.	Max.	Max.	Max.	
Percentage	F/C	F/C	F/C	F/C	F/C	F/C	F/C	F/C	
ACETIC ACID	0-50	NR	100/38	100/38	100/38	100/38	150/65	NR	100/38
ACETIC ANHYDRIDE	--	NR	NR	NR	NR	NR	NR	NR	NR
ACETONE	100	NR	NR	NR	NR	NR	NR	NR	NR
ACRYLONITRILE	100	NR	NR	NR	NR	NR	NR	NR	NR
ALCOHOL, BUTYL	--	NR	NR	NR	NR	NR	NR	NR	NR
ALCOHOL, ETHYL	10	NR	150/65	NR	150/65	NR	150/65	NR	150/65
ALCOHOL, ETHYL	100	NR	NR	NR	NR	NR	NR	NR	NR
ALCOHOL, ISOPROPYL	10	NR	150/65	NR	150/65	NR	150/65	NR	150/65
ALCOHOL, ISOPROPYL	100	NR	NR	NR	NR	NR	NR	NR	NR
ALCOHOL, METHYL	10	NR	150/65	NR	150/65	NR	150/65	NR	150/65
ALCOHOL, METHYL	100	NR	NR	NR	NR	NR	NR	NR	NR
ALCOHOL, METHYL ISOBUTYL	--	NR	150/65	NR	150/65	NR	150/65	NR	150/65
ALCOHOL, SECONDARY BUTYL	--	NR	150/65	NR	150/65	NR	150/65	NR	150/65
ALUM	100	150/65	150/65	150/65	150/65	150/65	180/82	150/65	150/65
ALUM POTASSIUM	--	100/38	100/38	100/38	100/38	120/49	150/65	100/38	100/38
ALUMINUM CHLORIDE	10	NR	150/65	NR	150/65	100/38	180/82	NR	150/65
ALUMINUM HYDROXIDE	5 - 20	NR	150/65	NR	150/65	100/38	180/82	NR	150/65
ALUMINUM POTASSIUM SULFATE	100	150/65	150/65	150/65	150/65	150/65	150/65	150/65	150/65
AMMONIA, AQUEOUS	0-10	NR	100/38	NR	100/38	NR	100/38	NR	100/38
AMMONIA, GAS	--	NR	100/38	NR	100/38	100/38	NR	NR	100/38
AMMONIUM ACETATE	25	NR	100/38	NR	100/38	120/49	150/65	NR	100/38
AMMONIUM BICARBONATE	15	NR	120/49	NR	120/49	120/49	150/65	NR	120/49
AMMONIUM BISULFITE	--	NR	120/49	NR	120/49	NR	120/49	NR	120/49
AMMONIUM CARBONATE	25	NR	100/38	NR	100/38	120/49	150/65	NR	100/38
AMMONIUM CITRATE	10	NR	120/49	NR	120/49	120/49	180/82	NR	120/49
AMMONIUM FLUORIDE	--	NR	120/49	NR	120/49	NR	120/49	NR	120/49
AMMONIUM HYDROXIDE	5	NR	120/49	NR	120/49	NR	120/49	NR	120/49
AMMONIUM HYDROXIDE	10	NR	120/49	NR	120/49	NR	120/49	NR	120/49
AMMONIUM HYDROXIDE	20	NR	120/49	NR	120/49	NR	120/49	NR	120/49
AMMONIUM NITRATE	15	120/49	150/65	120/49	150/65	150/65	180/82	120/49	150/65
AMMONIUM PERSULFATE	5 - 20	NR	150/65	NR	150/65	150/65	180/82	NR	150/65
AMMONIUM PHOSPHATE	--	NR	120/49	NR	120/49	NR	120/49	NR	120/49
AMMONIUM SULFATE	15	120/49	150/65	120/49	150/65	150/65	180/82	120/49	150/65
ARESENIOUS ACID	--	NR	160/71	NR	160/71	NR	160/71	NR	160/71
BARIUM ACETATE	100	NR	NR	NR	NR	100/38	150/65	NR	NR
BARIUM CARBONATE	100	NR	NR	NR	NR	100/38	150/65	NR	NR
BARIUM CHLORIDE	100	NR	100/38	NR	100/38	100/38	150/65	NR	100/38
BARIUM HYDROXIDE	10	NR	NR	NR	NR	100/38	150/65	NR	NR
BARIUM SULFATE	100	NR	100/38	NR	100/38	120/49	150/65	NR	100/38
BARIUM SULFIDE	10	NR	NR	NR	NR	100/38	150/65	NR	NR
BEER	--	NR	120/49	NR	120/49	NR	120/49	NR	120/49
BENZENE	100	NR	NR	NR	NR	100/38	150/65	NR	NR
BENZENE IN KEROSENE	5	NR	160/71	NR	160/71	NR	160/71	NR	160/71
BENZENE SULFURIC ACID	5 - 20	100/38	150/65	100/38	150/65	150/65	180/82	100/38	150/65
BENZOIC ACID	5 - 20	NR	100/38	NR	100/38	120/49	150/65	NR	100/38
O-BENZOYL BENZOIC ACID	--	NR	160/71	NR	160/71	NR	160/71	NR	160/71
BENZYL ALCOHOL	100	NR	NR	NR	NR	NR	100/38	NR	NR
BENZYL CHLORIDE	100	NR	NR	NR	NR	NR	100/38	NR	NR
BORAX	5 - 20	100/38	150/65	100/38	150/65	100/38	150/65	100/38	150/65
BRASS PLATING SOLUTION	--	NR	160/71	NR	160/71	NR	160/71	NR	160/71
BUTYL ACETATE	--	NR	NR	NR	NR	NR	NR	NR	NR
BUTYRIC ACID	5 - 30	NR	120/49	NR	120/49	100/38	150/65	NR	120/49
BUTYLENE GLYCOL	100	150/65	150/65	150/65	150/65	150/65	150/65	150/65	150/65
CADMIUM CHLORIDE	--	NR	160/71	NR	160/71	NR	160/71	NR	160/71
CADMIUM CYANIDE PLATING	--	NR	120/49	NR	120/49	NR	120/49	NR	120/49
CALCIUM BISULFITE	--	150/65	160/71	150/65	160/71	150/65	160/71	150/65	160/71

Chemical Compatibility Guide (cont'd)

Chemical Environment	Calcium Carbonate - Dichloroethylene								
	Concentration Percentage	Flowgrip®		Supergrate™ Pultruded Grating		Supergrate™ Molded Grating		PulTex Structural Profiles	
		Polyester	Vinyl ester	Polyester	Vinyl ester	Polyester	Vinyl ester	1500/1525 Srs.	1625 Srs.
		Temp Max. F/C	Temp Max. F/C	Temp Max. F/C	Temp Max. F/C	Temp Max. F/C	Temp Max. F/C	Temp Max. F/C	Temp Max. F/C
CALCIUM CARBONATE	10	NR	100/38	100/38	120/49	150/65	NR	100/38	
CALCIUM CHLORIDE	10	NR	100/38	NR	100/38	120/49	150/65	NR	100/38
CALCIUM CHLORATE	10	NR	100/38	NR	100/38	120/49	150/65	NR	100/38
CALCIUM HYDROXIDE	5 - 20	NR	100/38	NR	100/38	100/38	150/65	NR	100/38
CALCIUM HYPOCHLORITE	10	NR	120/49	NR	120/49	100/38	150/65	NR	120/49
CALCIUM NITRATE	5	120/49	150/65	120/49	150/65	120/49	150/65	120/49	150/65
CALCIUM SULFATE	10	120/49	150/65	120/49	150/65	120/49	150/65	120/49	150/65
CALCIUM SULFITE	--	150/65	160/71	150/65	160/71	150/65	160/71	150/65	160/71
CAPRYLIC ACID	--	NR	160/71	NR	160/71	NR	160/71	NR	160/71
CARBON DIOXIDE	--	150/65	160/71	150/65	160/71	150/65	160/71	150/65	160/71
CARBON DISULFIDE	100	NR	NR	NR	NR	NR	NR	NR	NR
CARBON MONOXIDE GAS	--	100/38	150/65	100/38	150/65	150/65	150/65	100/38	150/65
CARBON TETRACHLORIDE	100	NR	100/38	NR	100/38	NR	120/49	NR	100/38
CARBONIC ACID	10	100/38	120/49	100/38	120/49	120/49	150/65	100/38	120/49
CARBON METHYL CELLULOSE	--	NR	120/49	NR	120/49	NR	120/49	NR	120/49
CASTOR OIL	100	150/65	150/65	150/65	150/65	150/65	150/65	150/65	150/65
CHLORINATED WAX	10	NR	120/49	NR	120/49	120/49	150/65	NR	120/49
CHLORINE DIOXIDE/AIR	--	NR	160/71	NR	160/71	NR	160/71	NR	160/71
CHLORINE DIOXIDE,WET GAS	--	NR	160/71	NR	160/71	NR	160/71	NR	160/71
CHLORINE DRY GAS	--	NR	160/71	NR	160/71	NR	160/71	NR	160/71
CHLORINE WET GAS	--	NR	160/71	NR	160/71	NR	160/71	NR	160/71
CHLORINE LIQUID	--	NR	NR	NR	NR	NR	NR	NR	NR
CHLORINE WATER	10	NR	120/49	NR	120/49	NR	120/49	NR	120/49
CHLOROACETIC ACID	0-50	NR	100/38	NR	100/38	NR	100/38	NR	100/38
CHLOROBENZENE	--	NR	NR	NR	NR	NR	NR	NR	NR
CHLOROFORM	100	NR	NR	NR	NR	NR	NR	NR	NR
CHLOROSULFONIC ACID	--	NR	NR	NR	NR	NR	NR	NR	NR
CHROMIC ACID	5	NR	100/38	NR	100/38	100/38	150/65	NR	100/38
CHROMIC ACID	20	NR	120/49	NR	120/49	NR	120/49	NR	120/49
CHROMIC ACID	30	NR	NR	NR	NR	NR	NR	NR	NR
CHROMIUM SULFATE	--	150/65	160/71	150/65	160/71	150/65	160/71	150/65	160/71
CITRIC ACID	5 - 30	120/49	150/65	120/49	150/65	120/49	150/65	120/49	150/65
COCONUT OIL	--	NR	160/71	NR	160/71	NR	160/71	NR	160/71
COPPER CHLORIDE	5	150/65	180/82	150/65	180/82	150/65	180/82	150/65	180/82
COPPER CYANIDE	5	150/65	180/82	150/65	180/82	150/65	180/82	150/65	180/82
COPPER FLUORIDE	--	NR	160/71	NR	160/71	NR	160/71	NR	160/71
COPPER NITRATE	--	150/65	NR	150/65	NR	150/65	NR	150/65	NR
COPPER BRITE PLATING	--	NR	120/49	NR	120/49	NR	120/49	NR	120/49
COPPER PLATING SOLUTION	--	NR	160/71	NR	160/71	NR	160/71	NR	160/71
COPPER MATTE DIPPING BATH	--	NR	160/71	NR	160/71	NR	160/71	NR	160/71
COPPER PICKLING BATH	--	NR	160/71	NR	160/71	NR	160/71	NR	160/71
COPPER SULFATE	--	150/65	160/71	150/65	160/71	150/65	160/71	150/65	160/71
CORN OIL	100	NR	100/38	NR	100/38	120/49	150/65	NR	100/38
CORN STARCH-SLURRY	--	NR	160/71	NR	160/71	NR	160/71	NR	160/71
CORN SUGAR	100	NR	150/65	NR	150/65	150/65	180/82	NR	150/65
COTTONSEED OIL	--	NR	160/71	NR	160/71	NR	160/71	NR	160/71
CRUDE OIL	100	NR	150/65	NR	150/65	150/65	180/82	NR	150/65
CYCLOHEXENE	--	NR	120/49	NR	120/49	NR	120/49	NR	120/49
CYCLOHEXENE VAPOR	--	NR	NR	NR	NR	100/38	150/65	NR	NR
DEIONIZED WATER	--	150/65	150/65	150/65	150/65	150/65	150/65	150/65	150/65
DETERGENTS SULFONATED	--	NR	160/71	NR	160/71	NR	160/71	NR	160/71
DI-AMMONIUM PHOSPHATE	--	NR	160/71	NR	160/71	NR	160/71	NR	160/71
DIBROMOPHENOL	--	NR	NR	NR	NR	NR	NR	NR	NR
DIBUTYL ETHER	--	NR	120/49	NR	120/49	NR	120/49	NR	120/49
DICHLORO BENZENE	--	NR	NR	NR	NR	NR	NR	NR	NR
DICHLOROETHYLENE	--	NR	NR	NR	NR	NR	NR	NR	NR

Chemical Compatibility Guide (cont'd)

Diethylene Glycol – Hydrogen Sulfide Aqueous

Chemical Environment	Flowgrip®				Supergrate™		Supergrate™		PulTex Structural Profiles		
	Concentration Percentage	Polyester		Vinyl ester		Pultruded Grating		Molded Grating		1500/1525 Srs.	
		Temp	Temp	Temp	Temp	Temp	Temp	Temp	Temp	Temp	Temp
		Max. F/C	Max. F/C	Max. F/C	Max. F/C	Max. F/C	Max. F/C	Max. F/C	Max. F/C	Max. F/C	Max. F/C
DIETHYLENE GLYCOL	--	NR	160/71	NR	160/71	NR	160/71	NR	160/71	NR	160/71
DIETHYL ETHER	100	NR	NR	NR	NR	NR	NR	NR	NR	NR	NR
DIMENTHYL PHTHALATE	--	NR	160/71	NR	160/71	NR	160/71	NR	160/71	NR	160/71
DIOCTYL PHTHALATE	--	NR	160/71	NR	160/71	NR	160/71	NR	160/71	NR	160/71
DIPROPYLENE GLYCOL	100	NR	120/49	NR	120/49	100/38	150/65	NR	120/49	NR	120/49
DODECYL ALCOHOL	--	NR	160/71	NR	160/71	NR	160/71	NR	160/71	NR	160/71
ESTER, FATTY ACIDS	--	150/65	160/71	150/65	160/71	150/65	160/71	150/65	160/71	150/65	160/71
ETHYL ACETATE	100	NR	NR	NR	NR	NR	NR	NR	NR	NR	NR
ETHYL BENZENE	--	NR	NR	NR	NR	NR	NR	NR	NR	NR	NR
ETHYL ETHER	--	NR	NR	NR	NR	NR	NR	NR	NR	NR	NR
ETHYLENE GLYCOL	100	100/38	150/65	100/38	150/65	150/65	180/82	100/38	150/65	100/38	150/65
ETHYLENE DICHLORIDE	--	NR	NR	NR	NR	NR	NR	NR	NR	NR	NR
FATTY ACIDS	10	120/49	150/65	120/49	150/65	150/65	180/82	120/49	150/65	120/49	150/65
FERRIC CHLORIDE	10	120/49	150/65	120/49	150/65	150/65	180/82	120/49	150/65	120/49	150/65
FERRIC NITRATE	10	120/49	150/65	120/49	150/65	150/65	180/82	120/49	150/65	120/49	150/65
FERRIC SULFATE	10	120/49	150/65	120/49	150/65	150/65	180/82	120/49	150/65	120/49	150/65
FERROUS CHLORIDE	--	150/65	160/71	150/65	160/71	150/65	160/71	150/65	160/71	150/65	160/71
FERROUS NITRATE	--	150/65	160/71	150/65	160/71	150/65	160/71	150/65	160/71	150/65	160/71
FERROUS SULFATE	--	150/65	160/71	150/65	160/71	150/65	160/71	150/65	160/71	150/65	160/71
8-8-8 FERTILIZER	--	NR	120/49	NR	120/49	NR	120/49	NR	120/49	NR	120/49
FLUOBORIC ACID	--	NR	120/49	NR	120/49	NR	120/49	NR	120/49	NR	120/49
FLUOSILICIC ACID	--	NR	160/71	NR	160/71	NR	160/71	NR	160/71	NR	160/71
FORMALDEHYDE	5 - 30	NR	100/38	NR	100/38	120/49	150/65	NR	100/38	NR	100/38
FORMIC ACID	25	NR	100/38	NR	100/38	NR	120/49	NR	100/38	NR	100/38
FUEL GAS	--	NR	160/71	NR	160/71	NR	160/71	NR	160/71	NR	160/71
FUEL OIL	100	NR	100/38	NR	100/38	100/38	120/49	NR	100/38	NR	100/38
GAS NATURAL	--	NR	160/71	NR	160/71	NR	160/71	NR	160/71	NR	160/71
GASOLINE AUTO	--	NR	160/71	NR	160/71	NR	160/71	NR	160/71	NR	160/71
GASOLINE AVIATION	--	NR	160/71	NR	160/71	NR	160/71	NR	160/71	NR	160/71
GASOLINE ETHYL	--	NR	160/71	NR	160/71	NR	160/71	NR	160/71	NR	160/71
GASOLINE SOUR	--	NR	160/71	NR	160/71	NR	160/71	NR	160/71	NR	160/71
GLUCONIC ACID	--	NR	160/71	NR	160/71	NR	160/71	NR	160/71	NR	160/71
GLUCOSE	100	150/65	180/82	150/65	180/82	150/65	180/82	150/65	180/82	150/65	180/82
GLYCERIN	100	150/65	180/82	150/65	180/82	150/65	180/82	150/65	180/82	150/65	180/82
GLYCOL ETHYLENE	--	150/65	160/71	150/65	160/71	150/65	160/71	150/65	160/71	150/65	160/71
GLYCOL PROPYLENE	--	150/65	160/71	150/65	160/71	150/65	160/71	150/65	160/71	150/65	160/71
GLYCOLIC ACID	--	NR	160/71	NR	160/71	NR	160/71	NR	160/71	NR	160/71
GOLD PLATING SOLUTION	--	NR	160/71	NR	160/71	NR	160/71	NR	160/71	NR	160/71
HEPTANE	100	100/38	150/65	100/38	150/65	120/49	180/82	100/38	150/65	100/38	150/65
HEXANE	100	100/38	150/65	100/38	150/65	120/49	180/82	100/38	150/65	100/38	150/65
HEXALENE GLYCOL	--	150/65	160/71	150/65	160/71	150/65	160/71	150/65	160/71	150/65	160/71
HYDRAULIC FLUID	100	NR	120/49	NR	120/49	120/49	150/65	NR	120/49	NR	120/49
HYDROBROMIC ACID	5 - 50	100/38	150/65	100/38	150/65	120/49	180/82	100/38	150/65	100/38	150/65
HYDROCHLORIC ACID	10 - 30	NR	120/49	NR	120/49	100/38	150/65	NR	120/49	NR	120/49
HYDROCYANIC ACID	--	150/65	160/71	150/65	160/71	150/65	160/71	150/65	160/71	150/65	160/71
HYDROFLUORIC ACID	--	NR	NR	NR	NR	NR	NR	NR	NR	NR	NR
HYDROFLOUSILICIC ACID	10	NR	160/71	NR	160/71	NR	160/71	NR	160/71	NR	160/71
HYDROZINE	100	NR	NR	NR	NR	NR	NR	NR	NR	NR	NR
HYDROGEN BROMIDE ,DRY	--	NR	NR	NR	NR	100/38	150/65	NR	NR	NR	NR
HYDROGEN BROMIDE , WET GAS	--	NR	160/71	NR	160/71	NR	160/71	NR	160/71	NR	160/71
HYDROGEN CHLORIDE , DRY GAS	--	NR	160/71	NR	160/71	NR	160/71	NR	160/71	NR	160/71
HYDROGEN CHLORIDE, WET GAS	--	NR	160/71	NR	160/71	NR	160/71	NR	160/71	NR	160/71
HYDROGEN PEROXIDE	--	NR	120/49	NR	120/49	NR	120/49	NR	120/49	NR	120/49
HYDROGEN SULFIDE DRY	--	NR	160/71	NR	160/71	NR	160/71	NR	160/71	NR	160/71
HYDROGEN SULFIDE AQUEOUS	--	NR	160/71	NR	160/71	NR	160/71	NR	160/71	NR	160/71

Chemical Compatibility Guide (cont'd)

Hydrogen Fluoride Vapors – Nitric Acid

Chemical Environment	Concentration Percentage	Flowgrip®		Supergrate™ Pultruded Grating		Supergrate™ Molded Grating		PulTex Structural Profiles	
		Polyester	Vinyl ester	Polyester	Vinyl ester	Polyester	Vinyl ester	1500/1525 Srs.	1625 Srs.
		Temp	Temp	Temp	Temp	Temp	Temp	Temp	Temp
		Max. F/C	Max. F/C	Max. F/C	Max. F/C	Max. F/C	Max. F/C	Max. F/C	Max. F/C
HYDROGEN FLUORIDE VAPORS	--	NR	NR	NR	NR	NR	NR	NR	NR
HYDROSULFITE BLEACH	--	NR	120/49	NR	120/49	NR	120/49	NR	120/49
HYPOCHLORUS ACID	--	NR	160/71	NR	160/71	NR	160/71	NR	160/71
IRON PLATING SOLUTION	--	NR	160/71	NR	160/71	NR	160/71	NR	160/71
IRON AND STEEL CLEANING BATH	--	NR	160/71	NR	160/71	NR	160/71	NR	160/71
ISOPROPYL AMINE	--	NR	100/38	NR	100/38	NR	100/38	NR	100/38
ISOPROPYL PALMITATE	--	150/65	160/71	150/65	160/71	150/65	160/71	150/65	160/71
JET FUEL	--	NR	160/71	NR	160/71	NR	160/71	NR	160/71
KEROSENE	--	NR	160/71	NR	160/71	NR	160/71	NR	160/71
LACTIC ACID	--	NR	160/71	NR	160/71	NR	160/71	NR	160/71
LAUROYL CHLORIDE	--	NR	160/71	NR	160/71	NR	160/71	NR	160/71
LAURIC ACID	--	NR	160/71	NR	160/71	NR	160/71	NR	160/71
LEAD ACETATE	100	NR	120/49	NR	120/49	100/38	150/65	NR	120/49
LEAD CHLORIDE	10	120/49	150/65	120/49	150/65	120/49	150/65	120/49	150/65
LEAD NITRATE	10	NR	100/38	NR	100/38	100/38	150/65	NR	100/38
LEAD PLATING SOLUTION	--	NR	160/71	NR	160/71	NR	160/71	NR	160/71
LEVULINIC ACID	--	NR	160/71	NR	160/71	NR	160/71	NR	160/71
LINSEED OIL	--	150/65	160/71	150/65	160/71	150/65	160/71	150/65	160/71
LITHIUM BROMIDE	--	150/65	160/71	150/65	160/71	150/65	160/71	150/65	160/71
LITHIUM CHLORIDE	25	NR	120/49	NR	120/49	100/38	150/65	NR	120/49
LITHIUM SULFATE	--	150/65	160/71	150/65	160/71	150/65	160/71	150/65	160/71
LITHIUM HYDROXIDE	10	NR	120/49	NR	120/49	100/38	150/65	NR	120/49
MAGNESIUM BISULFITE	--	NR	160/71	NR	160/71	NR	160/71	NR	160/71
MAGNESIUM CARBONATE	10	100/38	150/65	100/38	150/65	100/38	180/82	100/38	150/65
MAGNESIUM CHLORIDE	10	100/38	150/65	100/38	150/65	120/49	180/82	100/38	150/65
MAGNESIUM HYDROXIDE	10	NR	120/49	NR	120/49	100/38	150/65	NR	120/49
MAGNESIUM NITRATE	10	NR	120/49	NR	120/49	100/38	150/65	NR	120/49
MAGNESIUM SULFATE	10	100/38	120/49	100/38	120/49	100/38	150/65	100/38	120/49
MALEIC ACID	100	150/65	150/65	150/65	150/65	150/65	150/65	150/65	150/65
MERCURIC CHLORIDE	10	120/49	150/65	120/49	150/65	100/38	180/82	120/49	150/65
MERCUROUS CHLORIDE	10	120/49	150/65	120/49	150/65	120/49	180/82	120/49	150/65
METHANOL	--	NR	160/71	NR	160/71	NR	160/71	NR	160/71
METHYLENE CHLORIDE	--	NR	NR	NR	NR	NR	NR	NR	NR
METHYL ETHYL KETONE @ 120F	--	NR	NR	NR	NR	NR	NR	NR	NR
METHYL ISOBUTYL CARBITOL	--	NR	NR	NR	NR	NR	NR	NR	NR
METHYL ISOBUTYL KETONE	--	NR	NR	NR	NR	NR	NR	NR	NR
METHYL STYRENE	--	NR	NR	NR	NR	NR	NR	NR	NR
MINERAL OIL	100	150/65	150/65	150/65	150/65	150/65	150/65	150/65	150/65
MOLYBDENUM DISULFIDE	--	NR	160/71	NR	160/71	NR	160/71	NR	160/71
MONOCHLORIC ACETIC ACID	--	NR	NR	NR	NR	NR	NR	NR	NR
MONOETHANOLAMINE	--	NR	NR	NR	NR	NR	NR	NR	NR
MOTOR OIL	100	150/65	150/65	150/65	150/65	150/65	150/65	150/65	150/65
MYRISTIC ACID	--	-	160/71	-	160/71	-	160/71	-	160/71
NAPHTHA	100	150/65	150/65	150/65	150/65	150/65	150/65	150/65	150/65
NICKEL CHLORIDE	10	120/49	150/65	120/49	150/65	150/65	180/82	120/49	150/65
NICKEL NITRATE	10	120/49	150/65	120/49	150/65	150/65	180/82	120/49	150/65
NICKEL PLATING: (.4% Boric Acid)	--	NR	160/71	NR	160/71	NR	160/71	NR	160/71
NICKEL PLATING: (11% Nickel Sulfate, 2% Nickel Chloride, 1% Boric Acid)	--	NR	160/71	NR	160/71	NR	160/71	NR	160/71
NICKEL PLATING: (44% Nickel Sulfate, 4% Ammonium Chloride, 4% Boric Acid)	--	NR	160/71	NR	160/71	NR	160/71	NR	160/71
NICKEL SULFATE	10	120/49	150/65	120/49	150/65	150/65	180/82	120/49	150/65
NITRIC ACID	5 - 30	NR	100/38	NR	100/38	120/49	150/65	NR	100/38

Chemical Compatibility Guide (cont'd)

Nitric Acid Fumes – Silver Plating Solution

Chemical Environment	Flowgrip®		Supergrate™ Pultruded Grating		Supergrate™ Molded Grating		PulTex Structural Profiles	
	Polyester	Vinyl ester	Polyester	Vinyl ester	Polyester	Vinyl ester	1500/1525 Srs.	1625 Srs.
	Temp	Temp	Temp	Temp	Temp	Temp	Temp	Temp
	Concentration Max. Percentage	Max. F/C	Max. F/C	Max. F/C	Max. F/C	Max. F/C	Max. F/C	Max. F/C
NITRIC ACID FUMES	--	NR	NR	NR	NR	NR	NR	NR
NIBROBEZENE	--	NR	NR	NR	NR	NR	NR	NR
OCTONOIC ACID	--	NR	160/71	NR	160/71	NR	160/71	NR
OIL, SOUR CRUDE	100	NR	120/49	NR	120/49	120/49	150/65	NR
OIL, SWEET CRUDE	100	NR	120/49	NR	120/49	120/49	150/65	NR
OLEIC ACID	100	120/49	150/65	120/49	150/65	120/49	180/82	120/49
OLEUM (FUMING SULFURIC)	--	NR	NR	NR	NR	NR	NR	NR
OLIVE OIL	--	150/65	160/71	150/65	160/71	150/65	160/71	150/65
OXALIC ACID	--	150/65	160/71	150/65	160/71	150/65	160/71	150/65
PEROXIDE BLEACH:	--	150/65	160/71	150/65	160/71	150/65	160/71	150/65
(2% Sodium Peroxide-96%								
.025% Epsom Salts,								
5% Sodium Silicate 42°Be,								
1.4% Sulfuric Acid 66°Be)								
PHENOL	10	NR	NR	NR	NR	NR	120/49	NR
PHENOL SULFONIC ACID	--	NR	NR	NR	NR	NR	NR	NR
PHOSPHORIC ACID	5 - 50	100/38	150/65	100/38	150/65	120/49	180/82	100/38
PHOSPHORIC ACID FUMES	--	150/65	160/71	150/65	160/71	150/65	160/71	150/65
PHOSPHOROUS	--							
PENTOXIDE	--	150/65	160/71	150/65	160/71	150/65	160/71	150/65
PHOSPHOROUS TRICHLORIDE	100	NR	NR	NR	NR	NR	120/49	NR
PTHALIC ACID	100	NR	120/49	NR	120/49	100/38	150/65	NR
PICKLING ACIDS:	--	150/65	160/71	150/65	160/71	150/65	160/71	150/65
(Sulfuric And Hydrochloric)								
PICRIC ACID ALCOHOLIC	--	150/65	160/71	150/65	160/71	150/65	160/71	150/65
POLYVINYL ACETATE LATEX	--	NR	160/71	NR	160/71	NR	160/71	NR
POLYVINYL ALCOHOL	100	NR	100/38	NR	100/38	NR	120/49	NR
POLYVINYL CHLORIDE LATEX	--	NR	120/49	NR	120/49	NR	120/49	NR
With 35 (Parts Dop)								
POTASSIUM ALUMINUM SULFATE	10	120/49	150/65	120/49	150/65	150/65	180/82	120/49
POTASSIUM BICARBONATE	--	NR	120/49	NR	120/49	100/38	150/65	NR
POTASSIUM BROMIDE	10	NR	120/49	NR	120/49	100/38	150/65	NR
POTASSIUM CARBONATE	10	NR	120/49	NR	120/49	150/65	180/82	NR
POTASSIUM CHLORIDE	100	NR	120/49	NR	120/49	100/38	150/65	NR
POTASSIUM DICHROMATE	100	NR	120/49	NR	120/49	100/38	150/65	NR
POTASSIUM FERRICYANIDE	--	150/65	160/71	150/65	160/71	150/65	160/71	150/65
POTASSIUM FERROCYANIDE	--	150/65	160/71	150/65	160/71	150/65	160/71	150/65
POTASSIUM HYDROXIDE	10	NR	150/65	NR	150/65	120/49	180/82	NR
POTASSIUM NITRATE	10	120/49	150/65	120/49	150/65	120/49	180/82	120/49
POTASSIUM PERMANGANTE	100	100/38	150/65	100/38	150/65	120/49	180/82	100/38
POTASSIUM PERSULFATE	--	NR	160/71	NR	160/71	NR	160/71	NR
POTASSIUM SULFATE	10	120/49	150/65	120/49	150/65	150/65	180/82	120/49
PROPIONIC ACID	1 - 50	NR	120/49	NR	120/49	NR	120/49	NR
PROPIONIC ACID	50 - 100	NR	NR	NR	NR	NR	NR	NR
PROPYLENE GLYCOL	100	150/65	150/65	150/65	150/65	150/65	180/82	150/65
PULP PAPER MILL EFFLUENT	--	NR	160/71	NR	160/71	NR	160/71	NR
PYRIDINE	--	NR	NR	NR	NR	NR	NR	NR
SALICYLIC ACID	--	NR	140/60	NR	140/60	NR	140/60	NR
SEA WATER	--	150/65	150/65	150/65	150/65	150/65	150/65	150/65
SEWAGE TREATMENT	--	NR	100/38	NR	100/38	NR	100/38	NR
SEBACIC ACID	--	NR	160/71	NR	160/71	NR	160/71	NR
SELENIOS ACID	--	NR	160/71	NR	160/71	NR	160/71	NR
SILVER NITRATE	--	150/65	160/71	150/65	160/71	150/65	160/71	150/65
SILVER PLATING SOLUTION:	--	NR	160/71	NR	160/71	NR	160/71	NR
(4% Silver Cyanide, 7% Potassium								
Cyanide,5% Sodium Cyanide,								
2% Potassium Carbonate)								

Chemical Compatibility Guide (cont'd)

Soaps – Superphosphoric Acid

Chemical Environment	Concentration Percentage	Flowgrip®		Supergrate™ Pultruded Grating		Supergrate™ Molded Grating		PulTex Structural Profiles	
		Polyester	Vinyl ester	Polyester	Vinyl ester	Polyester	Vinyl ester	1500/1525 Srs.	1625 Srs.
		Temp	Temp	Temp	Temp	Temp	Temp	Temp	Temp
		Max. F/C	Max. F/C	Max. F/C	Max. F/C	Max. F/C	Max. F/C	Max. F/C	Max. F/C
SOAPS	--	NR	160/71	NR	160/71	NR	160/71	NR	160/71
SODIUM ACETATE	--	NR	160/71	NR	160/71	NR	160/71	NR	160/71
SODIUM BENZOATE	--	NR	160/71	NR	160/71	NR	160/71	NR	160/71
SODIUM BICARBONATE	--	150/65	160/71	150/65	160/71	150/65	160/71	150/65	160/71
SODIUM BIFLUORIDE	--	NR	160/71	NR	160/71	NR	160/71	NR	160/71
SODIUM BISULFATE	--	150/65	160/71	150/65	160/71	150/65	160/71	150/65	160/71
SODIUM BISULFITE	--	150/65	160/71	150/65	160/71	150/65	160/71	150/65	160/71
SODIUM BROMATE	--	150/65	140/60	150/65	140/60	150/65	140/60	150/65	140/60
SODIUM BROMIDE	--	150/65	160/71	150/65	160/71	150/65	160/71	150/65	160/71
SODIUM CARBONATE	0 - 25	NR	160/71	NR	160/71	NR	160/71	NR	160/71
SODIUM CHLORATE	--	NR	160/71	NR	160/71	NR	160/71	NR	160/71
SODIUM CHLORIDE	--	150/65	160/71	150/65	160/71	150/65	160/71	150/65	160/71
SODIUM CHLORITE	25	NR	160/71	NR	160/71	NR	160/71	NR	160/71
SODIUM CHROMATE	--	150/65	160/71	150/65	160/71	150/65	160/71	150/65	160/71
SODIUM CYANIDE	--	NR	160/71	NR	160/71	NR	160/71	NR	160/71
SODIUM DICHROMATE	--	150/65	160/71	150/65	160/71	150/65	160/71	150/65	160/71
SODIUM DI-PHOSPHATE	--	150/65	160/71	150/65	160/71	150/65	160/71	150/65	160/71
SODIUM FERRICYANIDE	--	150/65	160/71	150/65	160/71	150/65	160/71	150/65	160/71
SODIUM FLUORIDE	--	NR	120/49	NR	120/49	NR	120/49	NR	120/49
SODIUM FLOURO SILICATE	--	NR	120/49	NR	120/49	NR	120/49	NR	120/49
SODIUM HEXAMETAPHOSPHATES	--	NR	100/38	NR	100/38	NR	100/38	NR	100/38
SODIUM HYDROXIDE	0 - 5	NR	150/65	NR	150/65	NR	150/65	NR	150/65
SODIUM HYDROXIDE	5 - 25	NR	150/65	NR	150/65	NR	150/65	NR	150/65
SODIUM HYDROXIDE	50	NR	150/65	NR	150/65	NR	150/65	NR	150/65
SODIUM HYDROSULFATE	--	NR	160/71	NR	160/71	NR	160/71	NR	160/71
SODIUM HYPOCHLORITE	10	NR	120/49	NR	120/49	120/49	150/65	NR	120/49
SODIUM LAURYL SULFATE	--	150/65	160/71	150/65	160/71	150/65	160/71	150/65	160/71
SODIUM MONO-PHOSPHATE	--	150/65	160/71	150/65	160/71	150/65	160/71	150/65	160/71
SODIUM NITRATE	--	150/65	160/71	150/65	160/71	150/65	160/71	150/65	160/71
SODIUM SILICATE	--	NR	120/49	NR	120/49	120/49	150/65	NR	120/49
SODIUM SULFATE	--	150/65	160/71	150/65	160/71	150/65	160/71	150/65	160/71
SODIUM SULFIDE	--	NR	120/49	NR	120/49	120/49	150/65	NR	120/49
SODIUM SULFITE	--	NR	120/49	NR	120/49	120/49	150/65	NR	120/49
SODIUM TETRA BORATE	--	150/65	160/71	150/65	160/71	150/65	160/71	150/65	160/71
SODIUM THIOCYANATE	--	NR	160/71	NR	160/71	NR	160/71	NR	160/71
SODIUM THIOSULFATE	--	NR	160/71	NR	160/71	NR	160/71	NR	160/71
SODIUM TRIPOLYOPHOSPHATE	--	NR	160/71	NR	160/71	NR	160/71	NR	160/71
SODIUM XYLENE SULFONATE	--	NR	160/71	NR	160/71	NR	160/71	NR	160/71
SODIUM SOLUTIONS	--	NR	160/71	NR	160/71	NR	160/71	NR	160/71
SODIUM CRUDE OIL	--	150/65	160/71	150/65	160/71	150/65	160/71	150/65	160/71
SOVA OIL	--	150/65	160/71	150/65	160/71	150/65	160/71	150/65	160/71
STANNIC CHLORIDE	--	150/65	160/71	150/65	160/71	150/65	160/71	150/65	160/71
STANNOUS CHLORIDE	--	150/65	160/71	150/65	160/71	150/65	160/71	150/65	160/71
STEARIC ACID	--	150/65	160/71	150/65	160/71	150/65	160/71	150/65	160/71
STYRENE	--	NR	NR	NR	NR	NR	NR	NR	NR
SUGAR, BEET AND CANE LIQUOR	--	NR	160/71	NR	160/71	NR	160/71	NR	160/71
SUGAR, SUCROSE	--	150/65	160/71	150/65	160/71	150/65	160/71	150/65	160/71
SULFAMIC ACID	--	NR	160/71	NR	160/71	NR	160/71	NR	160/71
SULFANILIC ACID	--	NR	160/71	NR	160/71	NR	160/71	NR	160/71
SULFATED DETERGENTS	--	NR	160/71	NR	160/71	NR	160/71	NR	160/71
SULFUR DIOXIDE, WET OR DRY	--	NR	160/71	NR	160/71	NR	160/71	NR	160/71
SULFUR, TRIOXIDE/AIR	--	NR	160/71	NR	160/71	NR	160/71	NR	160/71
SULFURIC ACID	0 - 30	150/65	160/71	150/65	160/71	150/65	160/71	150/65	160/71
SULFURIC ACID	30 - 50	NR	160/71	NR	160/71	NR	160/71	NR	160/71
SULFURIC ACID	50 - 70	NR	120/49	NR	120/49	NR	120/49	NR	120/49
SULFUROUS ACID	10	NR	100/38	NR	100/38	NR	100/38	NR	100/38
SUPERPHOSPHORIC ACID (76% P2O5)	--	NR	160/71	NR	160/71	NR	160/71	NR	160/71

Chemical Compatibility Guide (cont'd)

Tall Oil – Zinc Sulfate

Chemical Environment	Concentration Percentage	Flowgrip®		Supergrate™ Pultruded Grating		Supergrate™ Molded Grating		PulTex Structural Profiles	
		Polyester	Vinyl ester	Polyester	Vinyl ester	Polyester	Vinyl ester	1500/1525 Srs.	1625 Srs.
		Temp	Temp	Temp	Temp	Temp	Temp	Temp	Temp
		Max. F/C	Max. F/C	Max. F/C	Max. F/C	Max. F/C	Max. F/C	Max. F/C	Max. F/C
TALL OIL	--	NR	150/65	NR	150/65	NR	150/65	NR	150/65
TANNIC ACID	--	NR	120/49	NR	120/49	120/49	150/65	NR	120/49
TARTARIC ACID	--	150/65	160/71	150/65	160/71	150/65	160/71	150/65	160/71
THIONYL CHLORIDE	--	NR	NR	NR	NR	NR	NR	NR	NR
TIN PLATING SOLUTION: (18%Stannous Fluoroborate, 7% Tin, 9% Fluoroboric Acid, 2% Boric Acid)	--	NR	160/71	NR	160/71	NR	160/71	NR	160/71
TOLUENE	--	NR	NR	NR	NR	NR	NR	NR	NR
TOLUENE SOLFONIC ACID	--	NR	160/71	NR	160/71	NR	160/71	NR	160/71
TRANSFORMER OILS: (Mineral Oil Types, Chloro-phenyl Types)	--	NR	NR	NR	NR	NR	NR	NR	NR
TRICHLOR ACETIC ACID	50	NR	160/71	NR	160/71	NR	160/71	NR	160/71
TRICHLORETHYLENE	--	NR	NR	NR	NR	NR	NR	NR	NR
TRICHLOROPENOL	--	NR	NR	NR	NR	NR	NR	NR	NR
TRICRESYL PHOSPHATE +A618	--	NR	120/49	NR	120/49	NR	120/49	NR	120/49
TRIDECYLBENZENE SULFONATE	--	NR	160/71	NR	160/71	NR	160/71	NR	160/71
TRISODIUM PHOSPHATE	--	NR	160/71	NR	160/71	NR	160/71	NR	160/71
TURPENTINE	--	NR	100/38	NR	100/38	NR	100/38	NR	100/38
UREA	--	NR	140/60	NR	140/60	NR	140/60	NR	140/60
VEGETABLE OILS	--	150/65	160/71	150/65	160/71	150/65	160/71	150/65	160/71
VINEGAR	--	150/65	160/71	150/65	160/71	150/65	160/71	150/65	160/71
VINYL ACETATE	--	NR	NR	NR	NR	NR	NR	NR	NR
WATER:									
DEIONIZED	--	150/65	160/71	150/65	160/71	150/65	160/71	150/65	160/71
DEMINERALIZED	--	150/65	160/71	150/65	160/71	150/65	160/71	150/65	160/71
DISTILLED	--	150/65	160/71	150/65	160/71	150/65	160/71	150/65	160/71
FRESH	--	150/65	160/71	150/65	160/71	150/65	160/71	150/65	160/71
SALT	--	150/65	160/71	150/65	160/71	150/65	160/71	150/65	160/71
SEA	--	150/65	160/71	150/65	160/71	150/65	160/71	150/65	160/71
WHITE LIQUOR (Pulp Mill)	--	NR	160/71	NR	160/71	NR	160/71	NR	160/71
XYLENE	--	NR	NR	NR	NR	NR	NR	NR	NR
ZINC CHLORATE	--	150/65	160/71	150/65	160/71	150/65	160/71	150/65	160/71
ZINC NITRATE	--	150/65	160/71	150/65	160/71	150/65	160/71	150/65	160/71
ZINC PLATING SOLUTION: (9% Zinc Cyanide, 4% Sodium Cyanide, 9% Sodium Hydroxide)	--	NR	120/49	NR	120/49	NR	120/49	NR	120/49
ZINC PLATING SOLUTION: (49% Zinc, Fluoroborate, 5% Ammonium Chloride, 6% Ammonium Fluoroborate)	--	NR	160/71	NR	160/71	NR	160/71	NR	160/71
ZINC SULFATE	--	150/65	160/71	150/65	160/71	150/65	160/71	150/65	160/71

Chemical Compatibility Guide information is based on full immersion laboratory tests and resin manufacturers' data. In some environments, splashing may lead to further corrosion than indicated due to the evaporation of water. Regular washdown is recommended in these situations. All data represents the best available information, is believed to be correct, and is not a warranty of product performance. User tests are recommended to determine actual suitability of service, for which CP will gladly supply samples. CP does not take responsibility for design or suitability of materials for service intended, nor will CP be held liable for consequential or special damages due to defective material or workmanship including, without limitation, labor charge and/or other expense of damage to properties resulting from loss of materials or profits, or increased expenses of operation.

They are expected typical values. Depending on the individual resin formulation/fiber volume of the composite, additional testing may be needed.

“- -” = All Concentrations

“NR” = Not Recommended

Chapter 7 Custom Profile Design



Custom profiles are created from a wide variety of resin systems and an array of colors.

Several items need to be considered in the cross-sectional design of a custom pultruded profile. The following elements are conducive to efficient profile production. Although not absolutes, there are important considerations that can affect the economics of the system from tooling costs to price per piece.

Wall-Section Thickness

The rate at which a profile is produced is determined by the curing time required for the thickest section: the thicker the section, the slower the cure rate. For example, a 1/8-inch thick profile can be produced at 3 – 4 feet per minute. In comparison, a 3/4-inch thick profile section has a production rate of approximately 6-inches per minute. Whenever possible, it is advantageous to design a section with uniform cross-sectional wall thickness.

Pultruded profiles exhibit a 0% to 4% cross-sectional shrinkage during production. A uniform wall thickness aids in limiting the warpage of the end product, because shrinkage will be uniform.

Symmetrical design, although not necessarily of uniform thickness, also helps in controlling warpage.

Pultruded sections of .032 to 2 inch thickness, with solid rounds up to 3-inch diameters, are currently produced, but typical structural laminates range from .080 inches to 1 inch in thickness. Again, the thickness determines the pull rate; therefore, when rigidity is an important consideration, it is preferred to design deeper sections with a thinner wall.

Radius Design

Radius in pultruded profiles is the curved connection of two intersecting sections. With pultrusion, the best practice is to maintain uniformity of cross-section through the radius. It helps to prevent resin-rich areas that can crack or flake. Uniformity also aids in a more even distribution of glass reinforcement and helps to maintain consistent properties throughout the profile.

While square corners are obtainable, generous radii aid in processing and in-feed guiding systems. Generous radii also help to distribute stress in corners or cross-sectional changes, resulting in stronger profiles.

Although profile cross-section is the determining factor when calculating radii, a minimum of 1/16 inch is recommended for interior or exterior surfaces. The minimum radius is especially important on profiles

where surface appearance is critical, particularly where reinforcing ribs are necessary on the opposite side. A radius that is too generous can cause shrink marks and off-color areas in the profile.

On dead-end sections, it is particularly helpful to maintain a radius of half the thickness.

Shrinkage

Pultruded profiles typically shrink 2% to 3% during processing. Since the shrinkage is caused by the resin, changes in the type of resin or resin content will affect the final profile shrinkage. Proper die design will allow for this shrinkage.

Shrinkage, though a small percentage of the profile thickness, must be taken into consideration when establishing tolerances.

Shrinkage can be controlled with low-shrink resin systems. These systems typically contain thermoplastics that lessen shrinkage. Some problems that may be experienced in the final product are: decreased weatherability; lower peak temperature usage; reduced corrosion resistance; and lessened paint and bonding agent adhesion.

Shrinkage can also affect the angular relation of one section to another. Again, proper design of the die can lessen this problem, but variances do occur, and must be considered when establishing tolerances.

Surface Appearance And Performance

Pultrusions manufactured by a low-pressure process typically display a glass-rich surface. The surface can create several problems, such as pattern-through of reinforcing materials and exposure of glass fibers due to excessive wear or weathering.

When pattern-through is a problem, there are several methods for surface improvement. Low-shrink resin systems can dramatically lessen this occurrence. By lowering resin shrinkage, the surface of the profile remains smooth and uniform. Finer fiber mats and surfacing veils also improve surfaces by creating a smooth backing and attract more resin to the surface, masking the coarser fibers beneath.

Where pattern-through and exposed fibers are both a problem, a polymeric surface veil is available and used to create a resin-rich surface of up to .020 inches thick without detracting from the profile's performance. The surface improves the weatherability, ultraviolet resistance and corrosion resistance of the laminate. It will effectively coat the material with the base resin in-line and eliminate the need for secondary coating operations on areas other than end-cut or fabricated holes.

Since pultrusion is a low-pressure process, fiberglass reinforcements normally appear close to the surface of the profile. The reinforcements can affect the appearance, corrosion resistance or handling of the product. Fiberglass and polymeric veils can be added to the laminate construction to depress the reinforcement from the surface. This is done to enhance the surface by adding a resin-rich finish to the profile. The two most commonly used products are A-glass and polymeric veils.

To extend long life during outdoor exposure, urethane coatings are employed. In this secondary operation, a typical application is 25 to 40 microns. These coatings protect the profiles from UV degradation and are generally recommended when they will be exposed to a variety of weather conditions. They are also beneficial for profiles in which uniformity of color or variety of color is required in a low volume application.

To determine the proper surface treatment, artificial weathering or accelerated corrosion tests can be employed.

Parting Lines

Pultruded dies are typically segmented to aid in machining and facilitate chrome plating of the die surface. Where these segments join in the assembled die, surface marks are created on the profile. These marks are referred to as parting lines. A parting line will appear as a straight, slightly raised area on the profile. On structural profiles, these lines are unimportant, as most of them are incorporated into ends or corners where they are fairly well concealed. On profiles where surface appearance is critical, these parting lines must be taken into consideration. It is best for the designer to consult with Creative Pultrusions to establish the part configuration and die segmentation to produce the best profile without dramatically affecting the tooling and price per piece due to difficulties.

Localized Stiffening

Although this section may seem contradictory to some earlier statements, localized strength and stiffening are obtainable by various methods. Distribution of glass loadings or changes in reinforcement types can provide localized strength. By replacing materials of lesser strength with higher strength, the end product physical properties can be altered to meet necessary requirements.

Additional ribs or added thickness can also be used for reinforcing a profile as necessary. Creative Pultrusions can greatly aid the designer in cross-sectional development to best meet the end requirements.

Undercuts

Unlike some other processes, undercuts are obtainable with pultruded profiles. The main consideration when working with undercuts is the machining and plating of the tool.

Dimensional Tolerances

Standard tolerances for pultruded profiles have been established by the industry and ASTM committees. Workable tolerances are best established as a joint effort between the designer and the pultruder. As with most other processes, tight tolerances affect the costs of the end product. It is important to take this into consideration when establishing tolerances. Tolerances of particular segments of a cross-section are also an effective method of meeting the needs of both the designer and the pultruder.

Designer Checklist

1. Company Information

Company Name _____

Name _____

Department or Position _____ Phone _____

2. Profile Application Information

A. Profile Name _____ **Number** _____

New Design

Profile Modification

Existing Design

Profile Application _____

Present Material Used _____

Current Material Cost _____ Annual Volume _____ Release Quantity _____

B. Profile Dimensions Height _____ Width _____ Length _____

Actual Print Attached

Conceptual Sketch Attached

Is sample available?

Yes

No

Have you used FRP before?

Yes

No

Were the results satisfactory?

Yes

No

If no, please explain _____

Color _____

Surface Appearance/Cosmetic Requirements _____

Designer Checklist (cont'd)

C. Properties Standard Custom

Primary loads on part _____

Critical properties required _____

Electrical requirements _____

Resin Fire Retardant _____ Polyester _____ Vinyl ester _____ Other (please specify) _____

ASTM NBS UL Fed. Spec Other

D. Fabrication

Drilling Punching Grinding

Assembly _____

Finishing _____

Painting _____

Bonding _____

E. Environmental Considerations

Chemical Exposure Type (s) _____

Service Temperatures _____

Intermittent Continuous

Degree of Exposure

Immersion Vapors Splash

Concentration % by weight _____

Indoor _____ Outdoor _____

F. Other Requirements/Comments _____

Notes

Chapter 8 Quality Assurance and Standard Tolerances



Coupon testing is conducted to verify mechanical properties.

Profiles are subjected to rigorous testing, insuring customer specifications are met.



Full section bending test is conducted to assure product performance.

Quality Assurance System

To provide consistency in the production of PulTex Profiles, a Quality Assurance System is followed. Inspection points have been established to cover incoming raw materials, various stages of production, and follow-up to production before shipment. In addition, routine quality audits are performed internally, and by large-contract customers, to assure adherence to our quality assurance system.

Standard Tolerances

A better understanding of the dimensional and physical property capabilities of the material can assist the designer in determining the performance limitations of the product before it is produced.

In addition to those tolerances provided on the following pages, the designer should consult with the reference standards for background information and as a guideline in determining dimensional performance.

ASTM 3647

Standard Practice for Classifying Reinforced Plastic Pultruded Products According to Composition

ASTM D3917

Standard Specifications for Dimensional Tolerances of Thermosetting Glass Reinforced Plastic Pultruded Products

ASTM D3918

Standard Definitions of Terms Relating to Reinforced Plastic Pultruded Products

Standard Tolerances Index

- I. Cross Sectional Dimensions
 - A. PulTex Structural Profiles
 - B. PulTex Round and Square Tubes
 - C. PulTex Round and Square Bars
 - D. PulTex Flat Sheets
- II. Straightness
 - A. PulTex Rectangular Bars
 - B. PulTex Rods and Square, Hexagonal, and Octagonal Bars
 - C. PulTex Structural Profiles
 - D. PulTex Round, Square and Rectangular Tubes
 - E. PulTex Camber (Lateral Bow), Sheets and Plates
- III. Flatness
 - A. PulTex Rods, Bars, and Structural Profiles
 - B. PulTex Sheets and Plates
 - C. PulTex Hollow Profiles
- IV. Twist
 - A. PulTex Bars, Tubes and Structural Profiles
- V. Angularity
- VI. Length
- VII. Squareness of End Cut
 - A. PulTex Structural Profiles
 - B. PulTex Sheets and Plates
- VIII. STANDARD DIMENSIONAL TOLERANCES FOR PULTRUDED SHAPES FABRICATION

Standard Tolerances of PulTex Standard Structural Profiles

I. Cross Sectional Dimensions

A. PulTex Structural Profiles

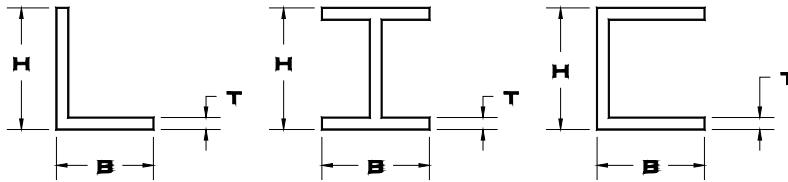

Allowable deviation from nominal dimensions						
	Angles		I-Beams		Channels	
Dimensions	Tolerance ±	Deviation ±	Tolerance ±	Deviation ±	Tolerance ±	Deviation ±
Thickness (T)	10%	.010" Minimum	10%	.010" Minimum	10%	.010" Minimum
Flange (B)	± 4%	.094" Maximum	± 4%	.094" Maximum	± 4%	.094" Maximum
Depth (H)	± 4%	.094" Maximum	± 4%	.094" Maximum	± 4%	.094" Maximum

B. PulTex Round and Square Tubes

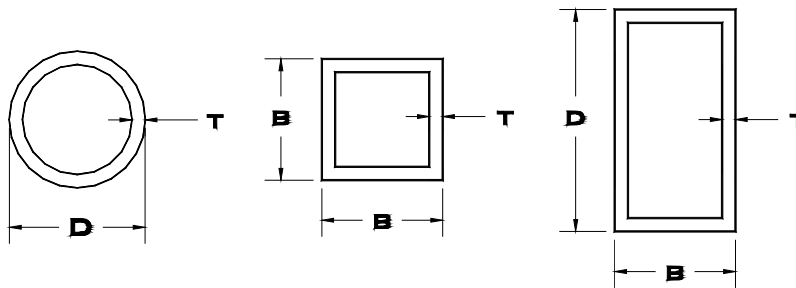

Dimensions (D) or (B)	Allowable deviation of depth at corners or diameter from specified
All	± 4% (.094" max)
Dimensions (T)	Tolerance
All	± 20% (± .010" min)

C. PulTex Round and Square Bars

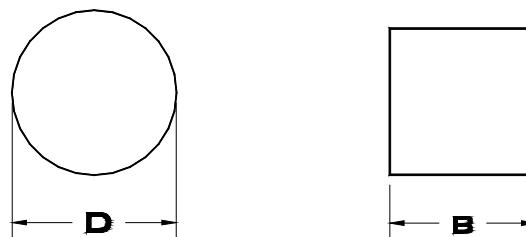

Dimensions (D) or (B)	Tolerances	Allowable Deviation
Width	± 4%	± .094" Maximum

D. PulTex Flat Sheets

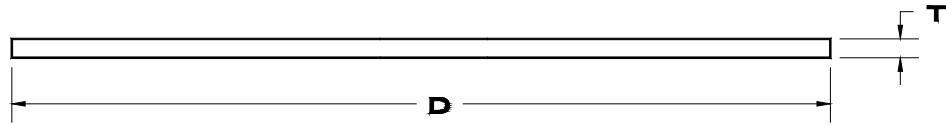

Dimensions	Tolerances	Allowable Deviation
Width (D)	$\pm 4\%$	$\pm .094''$ Maximum
Thickness (T) .125" and under	$\pm 15\%$	$\pm .010''$ Minimum
Over .125"	$\pm 10\%$	$\pm .050''$ Maximum

II. Straightness

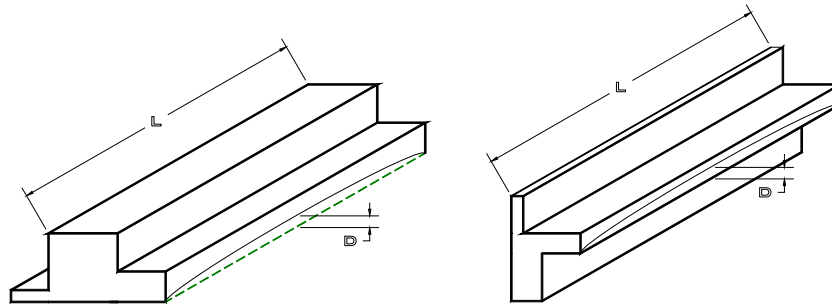

A. PulTex Rectangular Bars *

Allowable deviation from straight (D)			
Width of Profile	Wall thickness	Deviation	Deviation per part
Up to 1.499"	Up to .094"	.050"/ft	.050" x length (L)
Up to 1.499"	Over .094"	.040"/ft	.040" x length (L)
1.500" and Over	All	.040"/ft	.040" x length (L)

Note: length of part (L) in feet/meters

B. PulTex Rods and Square, Hexagonal, and Octagonal Bars*

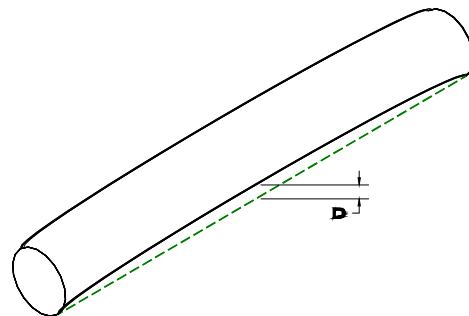

Allowable deviation from straight (D)		
Outside Dimensions	Deviation	Deviation per part
All	.030"/ft	.030" x length (L)

Note: length of part (L) in feet/meters

*Note: Straightness is measured when weight of pultrusion minimizes the deviation by contact with flat surface.

C. PulTex Structural Profiles, i.e., Channels, I-beams, Angles, etc.*

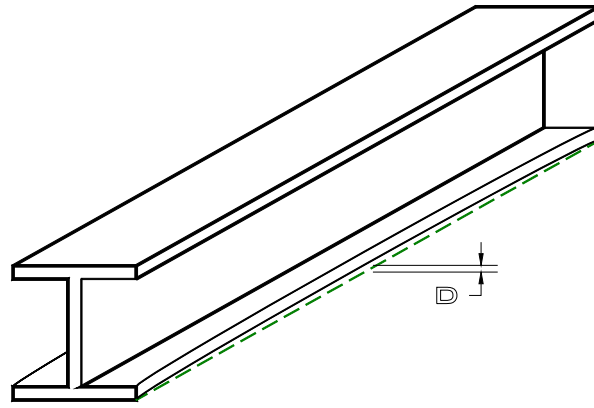

Allowable deviation from straight (D)		
Length	Deviation	Deviation per part
All	.050"/ft	.050" x length (L)

* Note: length of part (L) in feet/meters

D. PulTex Round, Square and Rectangular Tubes*

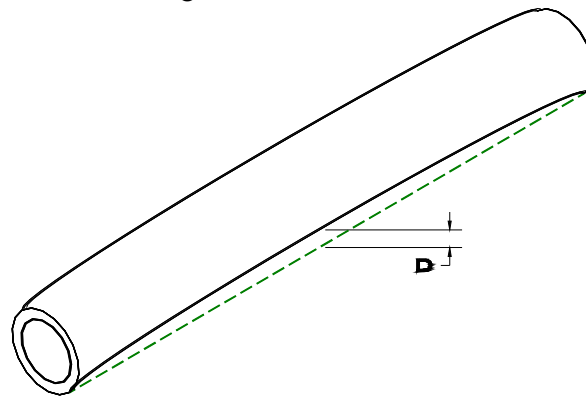

Allowable deviation from straight (D)		
Diameter/Depth	Deviation	Deviation per part
All	.030"/ft	.030" x length (L)

Note: length of part (L) in feet/meters

*Note: Straightness is measured when weight of pultrusion minimizes the deviation by contact with flat surface.

E. PulTex Camber (Lateral Bow), Sheets and Plates*

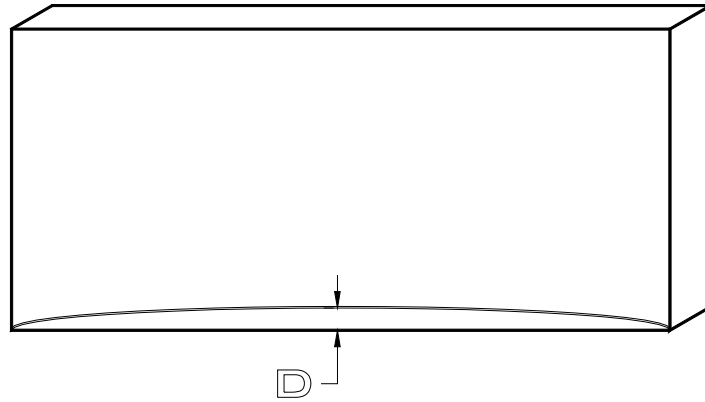

Allowable deviation from straight (D)	
All Thicknesses	.030" x length (L)

III. Flatness

A. PulTex Rods, Bars, Profiles and Structural Profiles

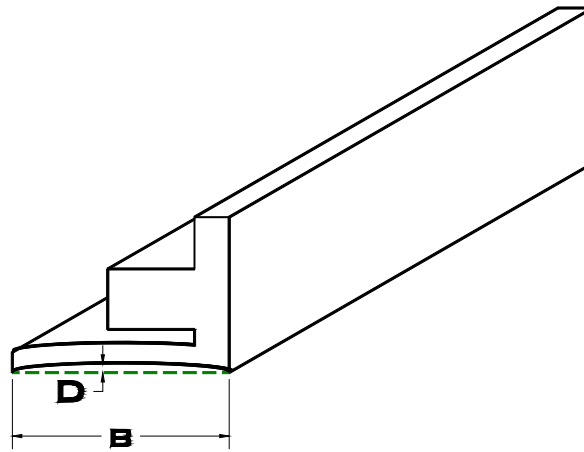

Allowable deviation from flat (D)	
Width (B)	Deviation
Up to 1"	0.008"
Over 1"	.008" x Width (B)
In any 1" of width	.008"

*Note: Straightness is measured when weight of pultrusion minimizes the deviation by contact with flat surface.

B. PulTex Sheets and Plates

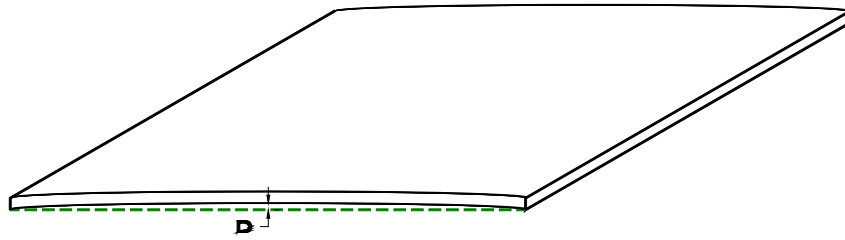

Allowable deviation from flat (D)	
All	.008" x Width (.250" max)

C. PulTex Hollow Profiles

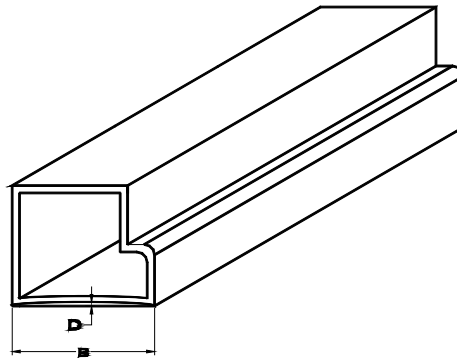

Allowable deviation from flat (D)		
Thickness	Dimensions up to 1" width (B)	Dimensions over 1" width (B)
Up to .187"	.012"	0.012 in/in of width
Over .187"	.008"	0.008 in/in of width

IV. Twist

A. PulTex Bars, Tubes and Structural Profiles

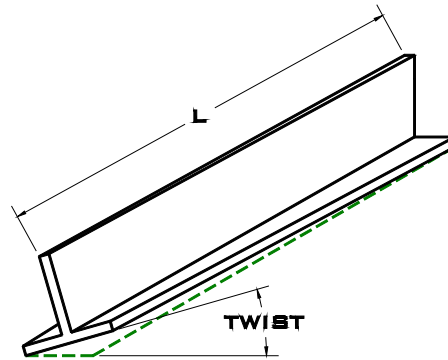

Allowable deviation from straight in degrees			
Width/Diameter	Thickness of profile	Twist per foot/meter	Twist per part length (ft)(m)
All Bars	All	1°	1° x length (ft)
All Open Shapes	All	1°	1° x length (ft)
All Closed Shapes	All	1°	1° x length (ft), 7° Max.

Note: length of part (L) in feet/meters

V. Angularity

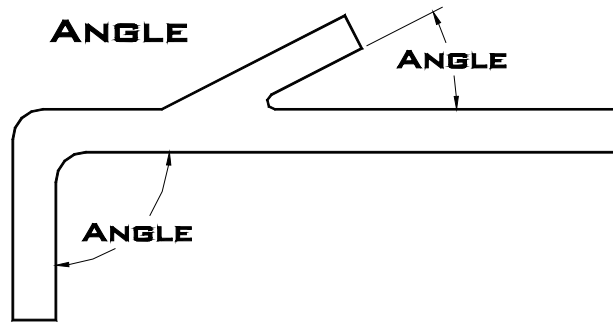

All PulTex Structural Profiles

Allowable deviation from specific angle		
Thickness	Angles less than 90°	Angles more than 90°
Up to .749"	± 2°	± 2°

VI. Length

All PulTex Structural Profiles

Allowable deviation from specific length		
Length up to 8'	Length Over 8' to 24'	Length Over 24'
+ .25", - 0"	+ .5", - 0"	+ 3", - 0"

VII. Squareness of End Cut

Allowable deviation from square	
Profiles over 2"	±1°
Profiles 2" and under	±2°

Structural Profiles: The previous tolerances have been established for the production of PulTex Fiber Reinforced Polymer Structural Profiles and represent customer acceptance standards for these products.

Custom Profiles: The selection, type and amount of fiberglass reinforcements, as well as the resin system used, directly affect dimensions of the finished product. These tolerances should be used as a **guide** between the end user and Creative Pultrusions in determining custom application specifications.

VIII. Standard Dimensional Tolerances for Pultruded Shapes Fabrication (CPQ212.0915)

PULTRUSION LINE CUT LENGTHS:

Length up to 8 ft. inclusive	Over 8 ft. to 24 ft. inclusive	Over 24 ft.
+ .25, - 0 inches	+ .50, - 0 inches	+ 3, - 0 inches

SECONDARY CUT LENGTHS

Length up to 20 feet (20 foot inclusive)	Over 20 feet to 30 feet (30 foot inclusive)	Over 30 feet to 40 feet (40 foot inclusive)	Over 40 feet
+/- 1/16 inch	+/- 1/8 inch	+/- 1/4 inch	+/- 1/2 inch

CNC or Custom Fixture Fabrications	Non-CNC Fabrications
<u>MITRE CUT or SQUARENESS OF END CUT:</u> Miter and end cuts typically not done on CNC. This is profile dependent and determined based on profile geometry.	<u>MITRE CUT or SQUARENESS OF END CUT:</u> Standard is +/- 1 degree related to x and y axis's. Tighter miter and squareness tolerances possibly achievable but determined on a case by case basis.
<u>RIP TO WIDTH TOLERANCE:</u> +/- 1/16 inch or as specified.	<u>RIP TO WIDTH TOLERANCE:</u> +/- 1/8 inch or as specified
<u>HOLE DIAMETER TOLERANCE:</u> +/- .020 inches up to 1" diameter inclusive or as specified (tighter dimensional tolerances are available upon request).	<u>HOLE DIAMETER TOLERANCE:</u> +/- .040 inches up to 1" diameter inclusive or as specified (tighter dimensional tolerances are available using CNC)
<u>HOLE or SLOTTED HOLE LOCATION TOLERANCE:</u> +/- 1/16 inch keyed from one origin, non-accumulative, or as specified.	<u>HOLE or SLOTTED HOLE LOCATION TOLERANCE:</u> +/- 1/8 inch keyed from one origin, non-accumulative, or as specified.
<u>SLOTTED HOLE SIZE TOLERANCE:</u> +/- 1/16 inch or as specified	<u>SLOTTED HOLE SIZE TOLERANCE:</u> +/- 1/8 inch or as specified.
<u>ROUT LENGTH TOLERANCE:</u> +/- 1/16 inch or as specified.	<u>ROUT LENGTH TOLERANCE:</u> +/- 1/8 inch or as specified.
<u>ROUT DEPTH TOLERANCE:</u> +/- 1/16 inch or as specified	<u>ROUT DEPTH TOLERANCE:</u> As specified + or - 1/8 inch.
<u>ROUT LOCATION TOLERANCE:</u> +/- 1/16 inch keyed from one origin, non-accumulative, or as specified.	<u>ROUT LOCATION TOLERANCE:</u> +/- 1/8 inch keyed from one origin, non-accumulative, or as specified.
<u>NOTCH or CUT-OUT TOLERANCE:</u> +/- 1/16 inch or as specified.	<u>NOTCH or CUT-OUT TOLERANCE:</u> +/- 1/4 inch or as specified.
<u>NOTCH or CUT-OUT LOCATION TOLERANCE:</u> +/- 1/16 inch keyed from one origin, non-accumulative, or as specified.	<u>NOTCH OR CUT-OUT LOCATION TOLERANCE:</u> +/- 1/8 inch keyed from one origin, non-accumulative, or as specified.
<u>NOTES:</u> <ul style="list-style-type: none"> Consult CPI when special tolerances are required. Tolerances are measured prior to resin sealing. 	<u>NOTES:</u> <ul style="list-style-type: none"> The above tolerances are for hand fabricated profiles without custom fixtures. Tighter tolerances may be achieved with the CNC and or custom-built fixtures. Consult CPI when special tolerances are required. Tolerances are measured prior to resin sealing.

Chapter 9 Fabrication Techniques



Many profiles are pre-fabricated, making on-site installation easy.

Almost all fabricating methods currently used for wood, aluminum, steel or other materials are available for fabrication of fiber reinforced polymer pultrusions.

To fabricate PulTex Profiles with complete success, the following techniques should be followed:

- Punches work better with a **slight shear edge**.
- Router bits should be **diamond-coated**.
- Drilling speeds should take hole size and thickness into consideration.
- Cutting speeds should be **moderately fast (3,450 rpm)**.
- Solvents, such as methylene chloride or acetone, should be used to prepare surface for bonding or coating.
- Lag screws are **not recommended** for fastening FRP to metal.
- Counter support is **necessary** when drilling hollow profiles.
- A **medium coarse** grinding wheel is preferable to the finer grades.

Each operation requires some change in technique or some modifications of equipment.

When fabricating, the most important characteristics of pultrusion are: it is a fibrous material with a grain (very much like wood); it is quite abrasive; it will bend. Although working with a fiberglass profile is similar to working with wood, it is uniquely a pultrusion and has its own characteristics. Explaining the nature of pultrusion fabrication is the purpose of this section of the manual.

Fabrication Of PulTex Structural Profiles

Before fabricating PulTex Profiles, several characteristics of the product itself should be recognized. These considerations apply to every phase of each operation.

1. Fiberglass is extremely abrasive. Tools, such as saw blades, router bits or punches, will wear quickly. Production problems will occur unless this problem is anticipated.
 - Frequent tool sharpening is common.
 - Diamond-coated edges and blades are the best.
 - Some re-tooling is common for heavy production.
 - Maintaining an at-hand inventory of saw blades, punches and other cutting tools is recommended.
2. Fiberglass is dusty during fabrication.
 - Minor health problems, such as skin irritation, may be experienced by some workers.
 - Wear dusk masks or respirators, long-sleeved shirts or coats.
 - Machines, such as saws, should have totally enclosed dustproof motors or better.
 - Machines, their supports and their general vicinities should be cleaned frequently. Dust and glass particles will build and become abrasive; and the machine will become damaged.
 - Vacuum hoses or vents should be placed near fabricating areas for dust collection.
3. Fiberglass, though strong, is also elastic. PulTex is typically produced in 20-foot lengths. Because of its greater length, increase in elasticity, warpage or twist may be experienced.
 - Rigid support is needed for **all** fabrication procedures.
 - Clamps, tie-downs, and vices should be incorporated **before and after** a section is to be cut.
 - Process designers should individualize clamp and support systems for each profile for each fabrication procedure. What is typical for aluminum is not necessarily appropriate for pultruded profiles. Rigidity is mandatory.
4. Fiberglass will degrade if exposed to friction. Ragged edges and material splits could result.
 - Always use appropriate machine speeds in each operation.
 - The greater the thickness, the slower the cutting or drilling speed.
5. Exposed fibers will absorb more moisture or other contaminants than resin-coated fibers. When

fabricating, the surface coating of resin is broken and fibers are exposed; therefore, it is always a good practice to coat fabricated areas with resin to prevent attack from the elements, whether it be corrosive agents or simple weathering.

6. All fastening procedures should be carefully appraised. Prototype testing should be included in the decision process.
 - Experience has demonstrated that mechanical fasteners and a good adhesive bond are the best procedures.
 - Choosing the correct adhesive is mandatory; bonding surfaces should be carefully prepared.
 - Process engineering should know the final product application and environment when considering fastening systems.
 - Fiberglass is a composite in which many variables are operating, such as ultra-violet exposure, chemical and temperature factors, and mechanical requirements. All fastening systems should take these variables into account.
 - Never assume that what works with aluminum, bronze, or wood will suffice for FRP. Concurrently, never assume that it won't. It is best to check first.
7. PulTex Profiles are composites that are engineered into laminate sections. **Do not** rigidly impose the fabrication requirements of homogenous materials, such as aluminum or cold rolled steel, on FRP, without first considering the composite characteristics of PulTex.
 - Properly understood, FRP will fabricate as well as any other material.
 - Tolerances, punch clearances and hole sizing should be gauged to the fibrous characteristics of FRP.

Adhesives/Bonding

Consult Creative Pultrusions for adhesive recommendations for your needs. Adhesives are an integral factor in fastening PulTex Profiles. As has been detailed, adhesives should be used in combination with other fastening devices whenever possible.

Thousands of formula for adhesives exist; the basic ones used with PulTex are:

1. Epoxies
2. Acrylics
3. Polyesters

Advantages Of Adhesives

- Distribute stress more uniformly.
- Permit fabrication at a lower cost and weight for structures that are mechanically equivalent to or stronger than conventional assemblies.

Advantages of Adhesives (cont'd)

- Bond thin sections to thick sections; thus, make use of the full strength of each section.
- Produce smooth surfaces.
- Eliminate defacing of exposed surfaces.
- Reduce weight.
- Join dissimilar materials.
- Accommodate differences in thermal expansion.
- Permit profile movement with flexible adhesives.
- Seal surfaces and joints.
- Accommodate thin or fragile profiles.

Bonded Shear Joint Concepts

The behavior of bonded joints is further challenged by several significant variables which requires an understanding of the mechanics of configuration necessary for efficient and successful design.

Four basic stresses are associated with joint behavior: **tensile, shear, cleavage and peel**. **Cleavage and peel stresses** are both special cases of **tensile stresses** involving large stress gradients through the joint. Joints developing direct tension or shear stresses are stronger and more reliable than joints subjected to cleavage and peel stresses.

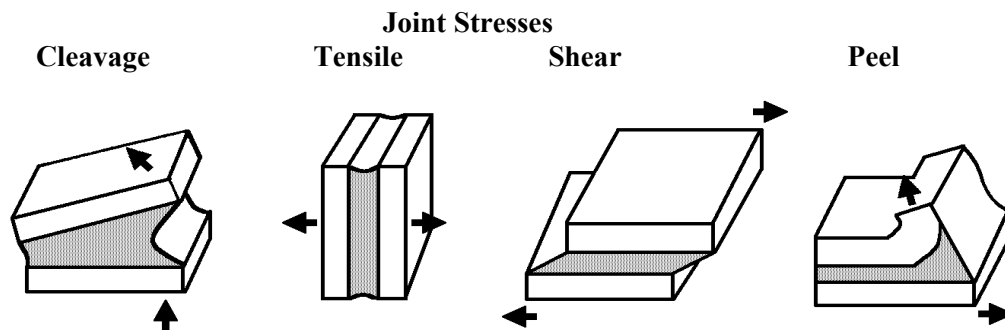

Symmetry of load transfer through a joint is to be held in highest esteem. (This axiom is also true for any material and connectors, such as bolts or welds.) **Non-symmetrical joints** induce couples, which must be resisted by cleavage or peel stresses.

With adhesive joints, flexibility of either the adhesive or the joined components is an advantage because it permits the connecting elements to rotate into alignment with the applied forces, thereby reducing the couple effect in the glue line. The geometric design of the joint can be used to improve strength and efficiency; for example, where a single lap joint is a very inefficient joint, it can be improved by using a low-modulus adhesive or beveling the joined elements to introduce some flexibility. The eccentricity of the joint may also be reduced by using a scarf type lap. (CAUTION: The desired stiffness of the joint must be observed if a joint is designed to maximize flexibility. Both cannot be achieved at the same time.)

The strength of a single lap (or any other nonsymmetrical joint) is not proportional to its size due to the stress concentration at the edges. The usual mechanism of failure in an adhesive joint is a crack propagation process initiating at points of high tensile stress; thus, failure is progressive and limited to a very small localized region at any given time, indicating that the overall size of the joint may be irrelevant to the total strength of the joint. Anything done to avoid the stress concentration will improve the integrity of the joint. The use of mechanical fasteners in cleavage stress regions, and void or crack-free glue lines, are methods in which joints can be strengthened.

Surface Preparations

The bond strength of an adhesive can be no better than the lap shear strength of the interlaminar material itself; in other words, surface is bonded to surface, resin to resin. The fiberglass reinforcement has little to do with achieving the bond strength.

The major fact in bonding PulTex Profiles is this: **because the profiles have been manufactured with a formulated mold-release, many adhesives will not react properly.**

Mold release agents rise to the surface of the profile during the manufacturing process. By removing this outer layer through proper surface preparation, the overly smooth surface can be abraded. Also, the majority of mold release agents will be removed. The procedures for surface preparation in painting can also apply.

Guidelines For Surface Preparations

1. Wipe contaminated surfaces with a solvent---styrene, toluene or methyl alcohol.
2. Wipe surface dry.
3. Remove surface film by sanding or light sand-blasting. Surface gloss should be removed.
4. Air blast the surface to remove any remaining dust. (Avoid recontamination by re-handling!)
5. Mix and apply adhesive 3 to 5 mils thick. Be certain that all surfaces and any glass fibers have been covered.
6. Clamp, screw and/or fasten the bonded surface.
7. Allow for proper cure time:
 - Ovens will shorten the cure time.
 - A minimum of 20 to 24 hours is an average length of time for many adhesives to bond.
 - A structure should not be exposed to its designed load limit until 48 hours have passed.
8. Always follow the adhesive manufacturer's recommendations.

Table 9-1 Adhesive Comparison Guide Used With PulTex Standard Structural and PulTex SuperStructural Profiles

Important Details	Epoxies	Acrylics
Product Advantages	Strongest average lap shear can be approximately 1200 psi Adheres to many surfaces	Lower cost Impurity tolerant
Substrates	Many use clean surfaces	Metals, glass, plastics, ceramics
Resistant to	Moisture, acids, bases, salts	Moisture, solvents, acids
Dispensing Methods	Meter mixing Hand mixing	Meter mixing Hand mixing
Strength	Strength to 6000 psi Average 1200 psi	Strength to 4000 psi Average 700 psi
Cure time	Varies	Varies
Formula available	Thousands	Many
Upper temperature range	Service Range -40°F and +160°F	250°F Maximum
Cost relative to other adhesives	Moderate	Moderate

Table 9-2 Comparison of Joining Techniques

	Mechanical Bonds	Adhesive Bonds
Seal (water tightness)	No	Yes
Thermal insulation	No	Yes
Electrical insulation	No	Yes
Stress concentration at joint	High	Medium
Strength/weight ratio	Low	Medium
Aesthetics (smooth joints)	Poor	Good
Fatigue endurance	Poor	Good
Inspection	Easy	Difficult
Skill required of fabricator	Low	High
Sensitivity to peel loading	No	Yes
Time to develop strength	Immediate	Varies
Disassembly	Possible	Impossible

Cutting/Sawing

The most common cuts are: (1) straight lines, (2) 20°-80° angles, (3) ripping, and (4) concentric cuts. Different saws are not required for cutting profiles of different resin systems; however, adequate support is necessary for **all** cutting procedures. Clamps are the preferred method for the hold-down function. These clamps can be either air cylinder hold-downs or the wide range of welding clamps such as the De-Sta-Co type. Precise cuts can be made if the profile is fastened on each side of the cut-line. Because dust will obscure the cutting marks and the heat of the saw may burn the material, it is advisable to use water-cooled blades for heavy production cutting. Parameter for cutting: Anything can be cut; thickness is not an issue, shape is.

Table 9-3 Machining Operations

Type of Saw	Application	Comments
Circular Power Saw	Straight cuts and ripping	a) The hand model is good for on-site fabrication with small to moderate numbers of cuts. b) The table saw is a better model for accuracy and support use, and is recommended for volume slitting or cutting when equipped with the proper blade.
Radial Arm Saw	Straight cuts and ripping	a) Good for large or thick sections. Water-cooled for large production. Blade sizes can be varied.
Saber Saw/Band Saw	Curved cuts	a) Adequate for very small quantities. Diamond-coated blades will increase production.
Hand Router	Curved cuts	a) Better for large production. Often the slot cut by the router bit will be wider or deeper than needed. It is a good practice to try the bit before designing fixtures; however, if properly done, this will yield precise results.
Radial Arm Saw with Swivel Head	20°-80° angle cuts	a) Can be used for mitering; 3,450 rpm recommended.
Hack Saw	Cutting rod stock	a) Hand variety good for limited cuts ---.94 – 1.25 teeth per mm. Power hack saw is better for large production. Tungsten carbide or diamond abrasive blades recommended. Keep plenty on hand as breakage is a problem.

Cutting Procedures

1. Blades should always be diamond or carbide-coated for large production; diamond blades should be 30 to 40 mesh.
2. Tolerances should be no less than $\pm 1/16$ inches for large productions.
3. Very often another more precise cutting is needed as a secondary procedure.
4. Precision cuts are also made with a (diamond-tipped) jig saw.
5. When mitering an end-cut, permit 1/2 to 1 inch waste area.
6. Infrequent circular cuts could use a metal cutting blade, although it will be dull after one cut.
7. Carbide-coated masonry blades are recommended for on-site fabrication.
8. For large section cuts, use the following:
 - a) begin with a power band saw for multiple cuts
 - b) use a circular saw and then invert material to finish the cuts

Operating Tips

1. When the edges begin to fray, reduce the saw speed.
2. If pultruded profiles are covered with nico or veil material, cut the visible side face-up.

Operating Tips (cont'd)

3. **Use a light, even touch!**
4. The thicker the profile, the slower the cut. Time must be taken and a saw with adequate horsepower used.
5. **Excessively high speed** will make the edges ragged and the diamonds will peel off the saw blade.

Design Note

For hollow sections with thin walls (.080 inches and under), counter supports may have to be designed to fit into the cavity. Or, you may need to purposely schedule a second-cut procedure. Unique custom profiles often require unique cut-off operations and equipment.

Drilling

Drilling PulTex Profiles is an easy, routine operation. Re-design of equipment is generally unnecessary. Standard twist drills are more than adequate for low production, but cobalt-bits are best for high production. Carbide-tipped bits are **not** required.

Parameters for Drilling

Drilling of PulTex Profiles is standard for sections with thicknesses of .187 inches or thicker.

Holes drilled in PulTex Profiles are generally undersized by .002 inches to .005 inches. A 1/8-inch drill bit will not make a hole large enough for a 1/8-inch rivet. A No. 30 bit is **necessary**. Oversize the drill bit in order to compensate for any shrinkage variation in fastener dimensions.

1. Drill PulTex Profiles as you would drill hard wood.
2. Feed drills slowly, even with higher speeds.
3. For profiles with surfacing veils, drill from the visible side to the non-visible side.
4. Off-centering can be a problem in mass production; use bushings for this procedure.
5. For riveting holes, use supplier's recommended clearance.
6. For larger holes, a back-up plate of wood or receiving bushing will prohibit fracturing or "breakouts" on the backside of the material.

Design Note

For round, hollow profiles and custom, hollow profiles, use sturdy counter-supports from within the hollow sections.

Grinding

Grinding of PulTex Profiles is not generally recommended; however, it is necessary for the following operations:

1. Notching
2. Recessing an internal wall in order to accommodate a flush fitting with another surface
3. Mounting secondary accessories or parts
4. Correcting inaccuracies in primary or secondary cuts (fragments, splinters)
5. Touching up edges

Parameters for Grinding

Grinding may be used for any thickness; results may vary.

Grinding Equipment

- Use any standard grinder. Air-powered equipment is preferred.
- Use carbide grinding wheels---especially for medium and coarse grit surfaces. (Fine surfaces will quickly clog.)
- Provide constant attention to the wheel surface. Grinding wheels need to be "dressed" or cleaned regularly.
- Operate at fairly high speeds. (1500 rpm plus)
- Centerless grinding for tubes and rods is very accurate.
- Use light pressure.

Turning

PulTex Profiles can be “turned” with standard metal working equipment on either a limited or a large-production basis.

Parameters For Turning

Dimensional tolerance for turning PulTex Profiles should be equated with cold rolled steel tolerances. Operation feed and speed limits should be geared as if for brass or aluminum.

Equipment

- For short production, steel tool cutters, with a single or multiple point, are satisfactory.
- For large or multiple production, carbide tool bits are a necessity.
- Round-nose lathe tools are best for good finishes.

Turning (cont'd)

- Use water coolants.
- Use climb cutting, not under cutting.
- For round-nose lathe tools, observe these pointers:
- The tool should display tight tolerance.
- Single points may tear the material, with sharp corners being rounded instead.
- The surface speeds must be regulated according to the desired finish.
- The speed must be geared to the hardness of the material and the type of cutting.
- The material should be fed continuously and steadily.
- Stopping and starting will noticeably mark the fiberglass.
- The cutters should be set slightly above the center of the material when lathing.

Design Note

Fiberglass is a composite material; turning it should be executed only after ample experimentation. Get to know the tolerances and the degree of hardness of each profile. Gauge the turning procedures to a medium range derived from that experiment.

Routing

A router can cut a straight line or any angle. With a special bit, routers can be used for cutting radii, keyways and milling profiles. The router cuts tend to be smooth and even which makes this an excellent choice. Frayed edges may then be avoided.

Thickness

Routing is done on parts that are 1/8 to 1/2 inches thick.

Equipment

Two types of routing machines are used:

- A hand-held air-powered model of 0 - 4,500 rpms
- A medium-sized table model of 4500 - 10,000 rpms

Tungsten-carbide coated rotary file bits are adequate for moderate production; however, the self-cleaning diamond-tipped, channeled or fluted bits serve even better for a routing operation.

Routing (cont'd)

Procedures

1. A coarser bit (36 mesh) will generally cut faster. Routing greatly improves when performed at a higher speed; however, with a 1/2-inch-thick profile, the pultrusion material will cause a great deal of friction. Caution should be exercised to avoid over-heating.
2. Use very light pressure when making router cuts. Forcing the bit could damage the material.

Design Note

A wide variety of router bits is available. As pultrusion gains the design flexibility of aluminum extrusions, routing will take on great significance. The versatility of the process adapts quite well to profile customization.

Punching

Fiberglass punches better than metal because it will spring back rather than bend. The amount of tonnage for punching is also somewhat less than aluminum, especially on a thinner profile.

Punching is one of the most common fabrication methods. It is very important for a number of secondary processes, such as fastening. If the inherent qualities of fiberglass are taken into account, punching can be effortless. If not taken into account, problems may arise.

It is also important to note that many basic rules applicable to metal are **not applied** when punching PulTex Profiles. Some differences to keep in mind are:

- The clearances between the punch and the die are not as generous with pultrusion.
- Hole sizing in pultrusion is typically "oversized" by as much as .002 to .030 inches.
- The standard 15% rule regarding die clearance and material thickness of metal **does not apply** to fiberglass.
- Standard metal punching equipment is **often** inadequate for pultrusion punching. The equipment must be realigned and/or fitted.

Procedure

1. The abrasiveness of pultrusion must be compensated for in the method of punching:
 - The punches need to be sharpened often.
 - The dies will need to be replaced or sharpened.
 - The overall tooling life may be shorter than the equivalent for metal punching.
 - It is common for punched holes to be drilled again in a secondary procedure when dictated by tight tolerances.

Punching (cont'd)

2. The fiberglass material will make dust and chips.
 - A clearance of .001 inches is not adequate. Dust will clog the female die almost instantly; thus, a punch would quickly be off-center.
 - The minimum clearance should always begin at .005 inches. For high-production lines or thicker sections of 3/16 inch or more, there is often a clearance of .010 to .020 inches.
3. All plastics are **not** the same.
 - Extremely close tolerances can be maintained for some thermoplastics.
 - Polyester, vinyl ester and epoxy thermosets are **not** as predictably tight; tolerances often have to be generous.
 - Mat-reinforced pultrusion (thermoset) **can** be punched to closer tolerances than those containing high roving.
4. Reinforced fiberglass is resilient.
 - The hold-down systems should be designed very carefully to compensate for this resiliency.
 - Strippers are mandatory.
 - Lubrication will gather the fiber and dust particles, thus quickly jamming the punch. A clean machine and work area at all times should eliminate this problem.
5. PulTex Profiles can deviate from specified tolerances regarding thickness, warpage, twist and straightness. Though the deviation may not extend beyond acceptable limits, punching accuracy and alignment may be affected.
 - System designers must take into account the degree of variance from specified tolerances.
 - System flexibility should be designed into the punching system.
 - Due to the flexibility of a pultruded profile, proper clamp-down systems can alleviate most of the problems associated with profile deviations.

Press Tonnage Requirements

Test results illustrate the shear strength values for PulTex Profiles.

The samples below were taken from one production run. The sample dimensions were circular coupons.

Thickness = 0.130 inches

Circumference = 3.132 inches

Results

Sample #1 Break	=	7,400 lbs.
	=	18,175 psi
Sample #2 Break	=	6,800 lbs.
	=	16,701 psi
Sample #3 Break	=	7,200 lbs.
	=	17,683 psi

- The average shear value for PulTex Profiles is 17,520 psi. Converted to pounds, the total is 7,133 lbs.
- The press tonnage required to punch fiberglass: .130 inches thick = 3.56 tons.
- Punching a 15/16-inch diameter hole in 10-gauge half-hard 1/4-inch thick aluminum requires 3.80 tons.

To determine the press tonnage values to punch PulTex Profiles, follow this procedure:

Multiply the profile material thickness by the hole circumference to be punched by the shear value.

Example: a 13/16-inch hole in a pultruded profile .077 inches thick is .077 inches (thickness) x 2.553 inches (circumference) x 17,000 psi (punch shear) = 3,342 lbs. pressure.

If 15 holes were going to be simultaneously punched, the number of holes would be multiplied by 3,342 pounds. In the above example, 50,130 pounds, or 25 tons of pressure, would be necessary for the multiple punch machine.

Always use the 17,520 psi (120.8 MPa) shear value in the calculation.

Equipment

The following punching equipment is used routinely at Creative Pultrusions:

Equipment	Application
(1) 3 Ton Press	1 to 6,000 pounds
(1) 5 1/2 Ton Press	Punching profiles of 1/8-inch thickness or smaller profiles from 1/8-3/16 inch thickness
(1) 13 Ton Brake Press	Punching profiles from 3/16 - 1/2 inch thickness

Design Note

Most fabrication shops are already equipped to punch aluminum sheet metal and cold rolled steel. Their machinery can be used for punching PulTex Profiles, if the punches are appropriate for fiberglass. Hold-down and support equipment should be evaluated for appropriateness, i.e., extra support.

Shear Angle in Punching

Rule: Optimum benefits for punching will be achieved when the punch is specially designed. **Only a small portion of the cutting edge should penetrate the material at any given time.**

During the punching cycle, the goal is to subject the minimum amount of fiberglass to the smallest fraction of cutting edge **on an even basis**. The punch should function as much like a scissor edge as possible.

To design shear angle into a punch, the following criteria can be observed:

- Shear strength of material
- Thickness
- Degree of resiliency
- Production needs
- Amount of hole clearance for fasteners
- Type of fasteners (if any)

Round, flat-headed punches **without shear edges** are routinely used in punching small round holes on an industry-wide basis with success.

Shear angle should be incorporated, if optimum benefits are desired. A shear angle that is equal to the material thickness will reduce the required tonnage by **one-third**.

Providing a **slighter** shear angle is the most effective method. Shear angles are used, not only to reduce tonnage, but to obtain a cleaner punch hole.

Doubling the shear angle to twice the material thickness of the profile is the recommended maximum angle. Shear angle should not exceed that limit.



Routing is one of many techniques used in fabrication.

Other Useful Guidelines for Punching

1. Some useful parameters are:
 - Oversize all holes by .020 to .030 inches.
 - The punched holes will range from .010 to .020 inches **smaller** than the punching die.
 - The larger the hole, the “cleaner” the punch.
 - Material thickness to be punched will range from .070 to .187 inches.
2. For **riveting**, punched holes occasionally have to be redrilled especially in parts with thickness of 1/8 inch or thicker.
3. Material Differences:
 - Mat-reinforced materials can be punched with exactness, especially when bushings are used.
 - Profiles with surfacing veils are punched from the non-visible to visible side.
4. A laminate .070 inches thick by 43 feet long, with a hole punched every 2 inches, has been punched successfully.
5. For materials 3/16-inch thick, rivet holes can be placed every 6-8 inches; for bolting, the holes should be 8-12 inches (203.2 mm – 304.8 mm).
6. The depth of a punch should be twice the thickness of the laminate.
7. When punching hollow profiles, use strong counter supports, such as mandrels or bottom carriage rests.

Shearing

Similar to punching, shearing is possible with PulTex Profiles. Profiles of 3/16-inch or thinner have been sheared successfully in production.

Shearing is very useful for large production, particularly in very thin laminates (.070 to .090 inches). Thicker profiles (.125 to .187 inches) can be sheared on flat sections, but shearing of profiles with multiple contours are best cut with a saw.

The rules for punching also apply to shearing, especially those rules referring to angles.

All shearing should be done perpendicular to any continuous fibers in the laminate.

Shearing should be perpendicular to the longitudinal reinforcements. Cuts must be clean.

Consideration of the shear angle should be of primary importance before specifying this procedure. Small profiles with a thickness not exceeding 3/16 inches can be sheared if the punch and profile are designed together.

Painting

For most applications, internal coloration and a variety of surface treatments eliminate the need for secondary coating operations. Situations exist, however, when paints are used to improve the weathering properties or the appearance of a pultruded profile.

For improved weathering, urethane coatings are recommended as they have superior ultraviolet resistance and adhere well to the pultruded substrate. Urethane-coated PulTex Profiles have been exposed to advanced weathering, equivalent to 30 years of exposure, with no loss in insulation properties and only a slight loss in mechanical properties. Non-skid coatings are available for slip resistant surfaces. These coatings are available from several suppliers and in a wide range of colors.

Surface Preparation

Due to the fact that the pultrusion process requires internal mold releases, it is essential that, prior to any painting or coating, the surface be properly prepared. The mold releases are a form of wax that creates a film on the surface of the profile to be removed. It can be accomplished with several methods:

- Solvent-wiping is the simplest method of surface preparation. Several solvents will attack the mold release films. Some of these are toluene, xylene, acetone, or styrene.
- Sanding will also adequately prepare the surface; however, when you break the surface at times, you will expose minor imperfections that become quite visible when paint is applied. A sand and fill primer can be applied to help this situation.

Sand-blasting can be used as a surface preparation technique, but exhibits the same problems as sanding.

It is best to follow the paint manufacturer's recommendations for the application of any type of coating.

Joining PulTex Structural Profiles

Channel Joints

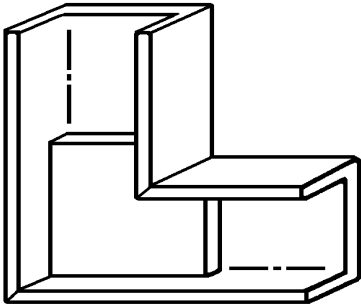
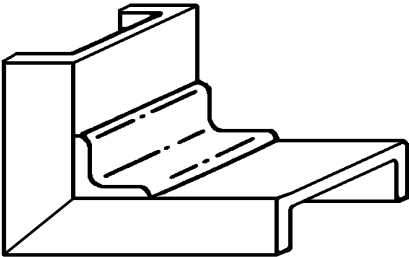
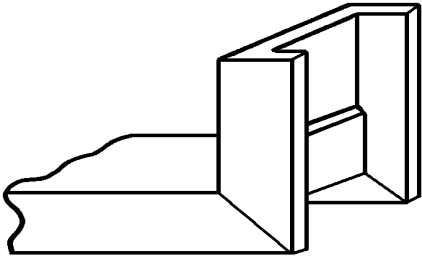
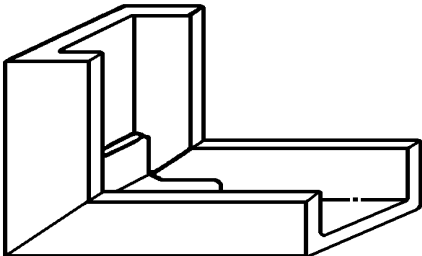

Joining PulTex Structural Profiles (cont'd)

Tube Joints

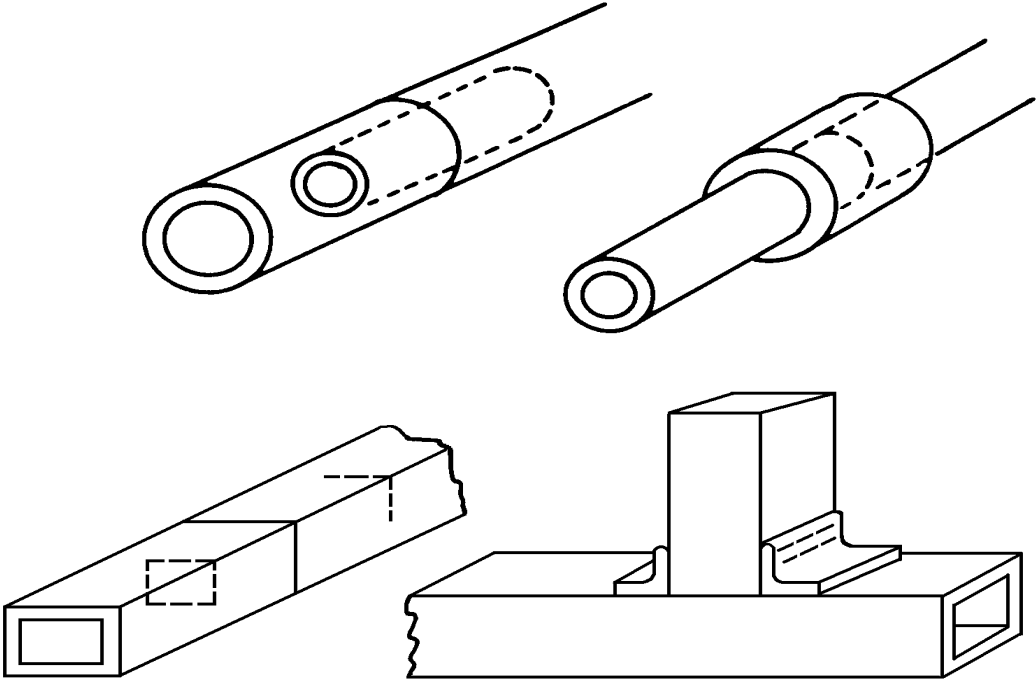

Fabricated Beams

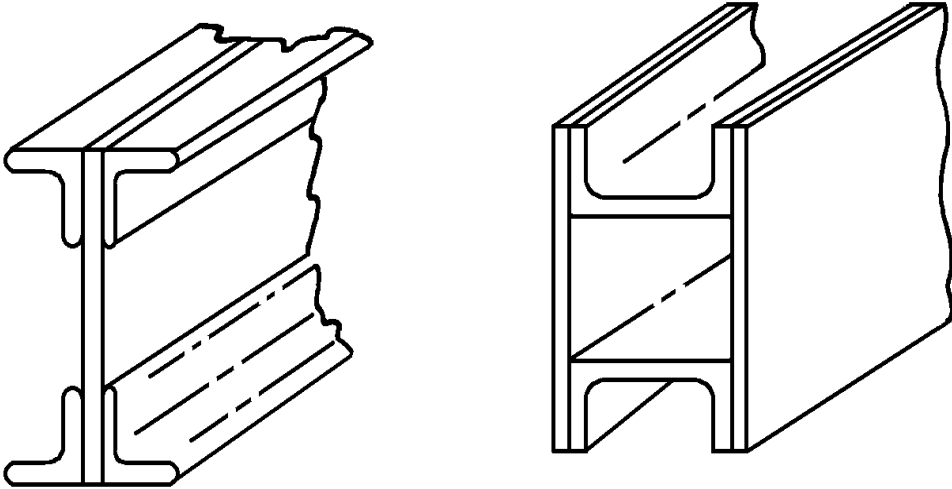

Joining PulTex Structural Profiles (cont'd)

I-Beam Joints

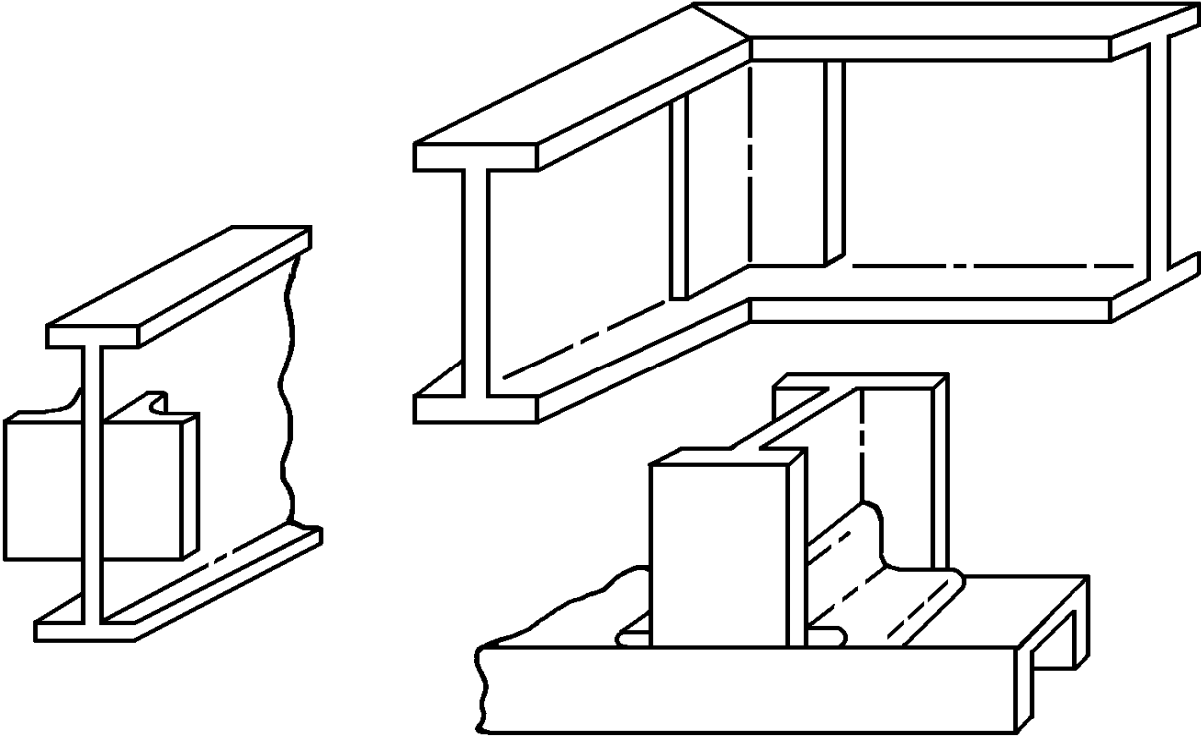

Platform Supports

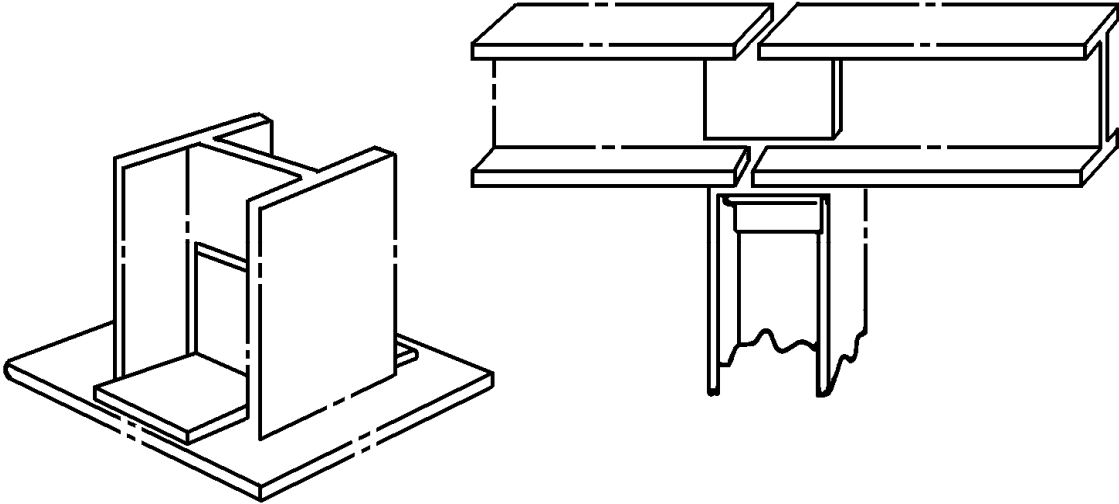

Mechanical Fastenings

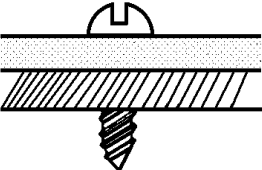
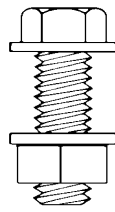
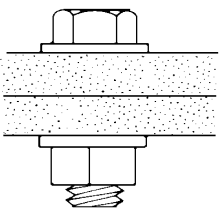
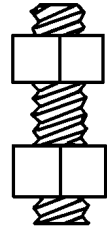
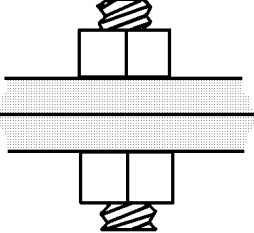
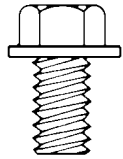
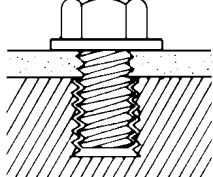
Application	Fastener	Engaged
<p>SCREW Used for fastening PulTex profiles to metal. Use metal as backup to fiberglass.</p>		
<p>BOLT AND NUT Used for fastening profiles together. Best to use washers to distribute load whenever possible. Steel, galvanized, silicon, bronze, nylon, polyester and other materials available for a wide range of applications. Check with your supplier.</p>		
<p>SUPERSTUD!™/NUTS! Threaded fiberglass rods with molded fiberglass nuts. Good for highly corrosion applications. Good shear values.</p>		
<p>BOLTS AND THREADED HOLE Possible assembly technique; however, special construction of PulTex Profile required. Fiberglass nuts above are made by this technique. Epoxies or other adhesives greatly improve joint strength.</p>		

Mechanical Fastenings (cont'd)

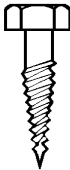
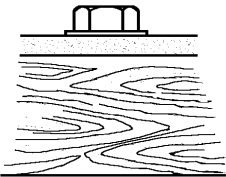
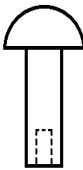
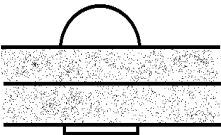
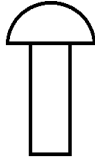
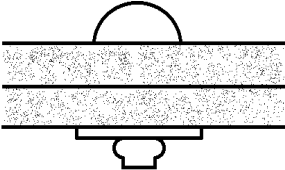
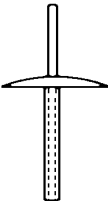
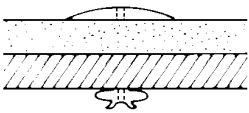
Application	Fastener	Engaged
<p>LAG SCREW Can be used to attach profiles to wood. Washer should be used to distribute load. Not recommended for attaching fiberglass to fiberglass.</p>		
<p>TUBULAR RIVET Used in conjunction with washer or metal backup plate. Stronger than pop-rivets because of solid shank. Requires accessibility from both sides of profile.</p>		
<p>SOLID RIVET Use with backup plate or washer. Must have accessibility to both sides of profile.</p>		
<p>BLIND RIVET Pull-up mandrel. Special tool required. Assembly from one side only. Good for fiberglass to metal or with washer backup. Steel or aluminum.</p>		

Mechanical Fastenings (cont'd)

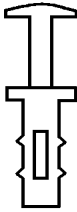
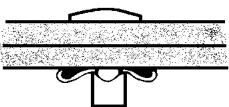
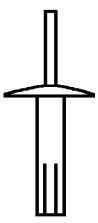
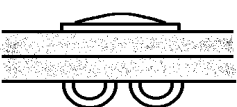
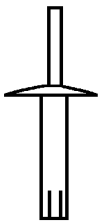
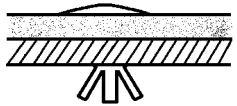
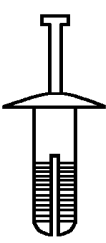
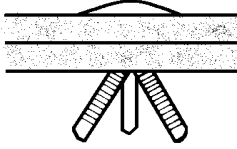
Application	Fastener	Engaged
<p>NYLON RIVET Crimp type rivet. Requires special tool for installation. Good for insulating in mildly corrosive environment.</p>		
<p>T-RIVET (Aluminum) Good for metal to fiberglass or fiberglass to fiberglass with backup plate. Wide expansion provides good load distribution and prevents tear.</p>		
<p>DRIVE RIVET (Aluminum) Good for fiberglass to metal. Can be installed with hammer. Can also be removed from one side by driving out mandrel.</p>		
<p>DRIVE RIVET (Nylon) Installed with hammer. Same as above. Lower shear value than metal. Center core stays in place.</p>		

Mechanical Fastenings (cont'd)

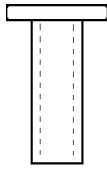
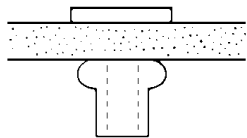
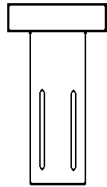
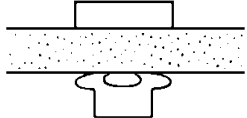
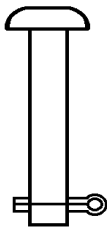
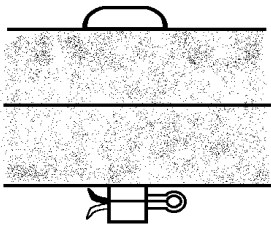
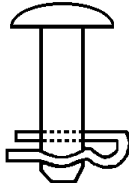
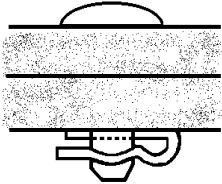
Application	Fastener	Engaged
<p>BLIND THREAD INSERTS Applies metal threads to profile. Good for products for which disassembly is required. Hexagon shape available to prevent twist. Special tool required.</p>		
<p>BLIND THREAD INSERTS Better torque and shear strength. Loads are more evenly spread on back surface.</p>		
<p>CLEVIS AND PIN (Metal) Can be used for some installations. Not normally a very tight fit.</p>		
<p>CLEVIS AND PIN (Nylon) Used in some installations. Electrical insulating properties.</p>		

Notes

Chapter 10 Writing Specifications for PulTex Fiber Reinforced Polymer Profiles

Writing Specifications for PulTex Profiles and Fabrications

Part 1 – General

1.01 Related Documents

- A. Drawings and general provisions of Contract, including General and Supplementary Condition Specifications apply to the Writing Specification Section.

1.02 Summary

- A. The following Fiber Reinforced Polymer Composites
 - PulTex Structural Profiles
 - PulTex **SuperStructural** Profiles
 - Supergrate™ Pultruded Grating
 - Supergrate™ Molded Grating
 - Flowgrip® Flooring Panel
 - Tuf-Dek™ Flooring Panel
 - Stair Treads

1.03 Scope of Work

- A. Furnish all labor, material and equipment to install the fiber reinforced polymer products as displayed on the drawings and as specified herein.

1.04 Quality Assurance

- A. The material specified will be furnished by a reputable and qualified manufacturer of demonstrated ability who has routinely engaged in the manufacture of Fiber Reinforced Polymer Composites.
- B. Substitution of any component or modification of system will be made only when approved by the Architect or Engineer.
- C. Qualifications are limited to experienced manufacturers and fabricators producing fiber reinforced polymer composite products similar to that indicated for this project, with adequate production capacity, so as to not delay the work.
- D. In addition to requirements of these specifications, comply with manufacturer's instructions and recommendations for work.

1.05 Design Criteria

- A. The design of fiber reinforced polymer composite products, including connections, will be in accordance with the governing building codes and standards, as applicable.

1.06 Submittals

- A. Drawings of all fiber reinforced polymer composite products will be submitted to the Engineer for approval in accordance with the necessary requirements of each specific project.
- B. Manufacturer's catalog of data displaying

Submittals (cont'd)

1. Dimensions, spacings and construction of products
 2. Design tables, with span length and deflection limits, under various uniform and concentrated loads
 3. Construction materials
- C. Detail drawings displaying
1. Dimensions of fiber reinforced polymer composite products
 2. Sectional assembly
 3. Location and identification mark

1.07 Shipping and Storage Instructions

- A. All systems, sub-systems and structures will be factory-fabricated and assembled to the best practical sizes for transportation.
- B. All material and equipment necessary for the fabrication and installation of the fiber reinforced polymer composite products will be stored before, during, and after shipment in a manner to prevent cracking, twisting, bending, breaking, chipping or damage of any kind to the material, or equipment, including ultraviolet damage. Any material, which in the opinion of the Engineer, becomes damaged as to be unfit for use, will be promptly removed from work site, and the Contractor will receive no compensation for the damaged material or its removal.
- C. Identify all materials, items, and fabrications for installation and field assembly.

Part 2 – Products

2.01 General

- A. Material used in the manufacturing of fiber reinforced polymer composite products of the best quality and free from defects and imperfections that may affect the performance of the finished product.
- B. All material will be of the type and quality specified; where quality is not specified, it will be the best of the respective types and applicable for the intended purpose.
- C. All standard 1525 and 1625 fiber reinforced polymer composite products noted in the Summary Section will be manufactured using the pultrusion manufacturing process, with either thermoset polyester or thermoset vinyl ester resins, including flammability and ultraviolet (UV) inhibitor additives. A synthetic surface veil will be the outermost layer of the exterior surface. The fiber reinforced polymer composite profiles will achieve a class 1 flammability rating (≤ 25) per ASTM E84 test method. (Thermoset polyester resin and vinyl ester resins are available without flame retardant and UV inhibitor additives.)
- D. After fabrication, all cut ends, holes and abrasions of fiber reinforced polymer composite products will be sealed with a compatible resin coating to prevent intrusion of moisture where applicable.

General (cont'd)

- E. Fiber reinforced polymer composite products, exposed to weather, will contain an ultraviolet inhibitor.
- F. All exposed surfaces will be smooth and true-to-form.
- G. Manufacturer's:
 - 1. Creative Pultrusions, Inc., PulTex Standard Structural Profiles, PulTex **SuperStructural** Profiles, Superstud!™/Nuts!, Flowgrip®, Supergrate™ and Tuf-dek™.
 - 2. or approved equal

2.02 Gratings and Treads

General

- A. Grating will be transported from the manufacturer, palletized and banded with exposed edges protected by cardboard to prevent damage.
- B. Each product will be clearly identified with the applicable drawing number.
- C. Grating will be Supergrate™, Flowgrip® or Tuf-dek™, as manufactured by Creative Pultrusions, Inc., Alum Bank, Pennsylvania.
- D. Grating will be specified by loading requirements. Specify grating type by using Solutions that Work---The Most Complete Line of Grating and Access Structure Products in the Industry, page #11 – 18 and 20c and 20d.

Design

- A. The panels will be _____ inches deep and sustain a deflection of no more than _____ inches under a uniform distributed load or point load over a span length of _____ inches. Reference Solutions that Work---The Most Complete Line of Grating and Access Structure Products in the Industry.
- B. The top surface of all panels will have a nonskid grit affixed to the surface. Reference “Solutions that Work---The Most Complete Line of Grating and Access Structure Products in the Industry”.
- C. Panels will be fabricated to the sizes shown on the drawings.

Hold down clamps will be type 316L stainless steel. A minimum of four each per panel.

(Select One)

Option 1: Color will be high visibility safety yellow. (OSHA safety yellow)

Option 2: Color will be gray. (OSHA safety gray)

Products

- A. The fiber reinforced polymer composite grating and stair treads will be fabricated from bearing bars and cross rods manufactured by the pultrusion process. The glass fiber reinforcement for the bearing bars will be a core of continuous glass strand rovings wrapped with continuous glass strand mat. A synthetic surface veil will be the outermost layer of covering for the exterior surfaces. Reference Solutions that Work---The Most Complete Line of Grating and Access Structure Products in the Industry.

2.03 Fiberglass Grating and Stair Treads

- A. Fiberglass grating and stair treads will be manufactured with a premium grade chemical resistant, fire retardant thermoset polyester or fire retardant thermoset vinyl ester resin system, with antimony trioxide included to meet the flame rating of 25 or less in accordance with ASTM E84 testing and the self-extinguishing requirements of ASTM D635. UV inhibitors are added to the resin.

2.04 Flowgrip® Flooring Panel or Supergrate™ Grating with Plate

- A. Grating will be the same as described above in this section.
- B. Plate will be PulTex flat sheet as manufactured by Creative Pultrusions, Inc., Alum Bank, Pennsylvania.
- C. Grating with plate will be manufactured with a premium grade polyester or vinyl ester resin with fire retardant additive to meet Class I flame rating of 25 or less as tested by ASTM E84 and the self extinguishing requirements of ASTM D635. All plate will contain a UV inhibitor.
- D. Grating with plate will be bonded to the grating, and non-skid grit will be affixed to the top surface.
- E. All cut and machined edges, holes and abrasions will be sealed with a resin equal to the resin used in manufacturing the product.
- F. All panels will be fabricated to the sizes displayed on the approved drawings.
- G. Grating with plate can be substituted with Flowgrip®; for additional information Reference Solutions that Work---The Most Complete Line of Grating and Access Structure Products in the Industry.

2.05 PulTex Structural Profiles

- A. Structural profiles will be manufactured with a premium grade polyester or vinyl ester resin with fire retardant additives to meet Class I flame rating of ASTM E84 and the self-extinguishing requirements of ASTM D635. All structural profiles will contain a UV inhibitor.
- B. Manufactured by the pultrusion process.
- C. Structural fiber reinforced polymer composite member composition will consist of a glass fiber reinforced polyester or vinyl ester resin matrix, approximately 50% resin-to-glass ratio. A synthetic surface veil will be the outermost layer of the exterior surfaces. Continuous glass strand rovings will be internally used for the longitudinal strength.

Continuous strand glass mats or stitched fabrics will be internally used for transverse strength.

For properties, reference the PulTex Fiber Reinforced Polymer Structural Profile Materials Properties Sheet, Superstud!TM/Nuts! Fiber Reinforced Polymer Fastener System Materials Properties Sheet, PulTex Fiber Reinforced Polymer Rod and Bar Materials Properties Sheet and PulTex Fiber Reinforced Polymer Flat Sheet Materials Properties Sheet. Reference Solutions that Work---The Most Complete Line of Grating and Access Structure Products in the Industry.

Part 3 – Execution

3.01 Installation – All Fiber Reinforced Polymer Composite Profiles

- A. All field cut and drilled edges, holes and abrasions will be sealed with a catalyzed resin compatible with the original resin as recommended by the manufacturer. The sealing of the edges will prevent premature fraying at the field cut edges.
- B. Install items specified as indicated and in accordance with manufacturer’s instructions.

Part 4 – Inspection and Testing

- A. The Engineer will have the right to inspect and test all to-be-furnished materials under these specifications prior to transportation from the point of manufacture.
- B. All labor, power, materials, equipment and appurtenances required for testing will be furnished by the Contractor at no cost to the Owner.

Part 5 – Subsection

Part 1 – General

- 1.01 Related Documents
- 1.02 Summary
- 1.03 Scope of Work
- 1.04 Quality Assurance
- 1.05 Design Criteria
- 1.06 Submittals
- 1.07 Shipping and Storage Instructions

Part 2 – Products

- 2.01 General
- 2.02 Gratings and Treads
- 2.03 Fiberglass Grating and Stair Treads
- 2.04 Flowgrip® Flooring Panel or SupergrateTM Grating With Plate
- 2.05 PulTex Structural Profiles

Part 3 – Execution

3.01 Installation – All Fiber Reinforced Polymer Composite Profiles

Part 4 – Inspection and Testing

Appendix A

Clip Connection Test Procedures

Double Cantilever Test

The objective of the double cantilever test is to develop full section data to be used by engineers, for the design of structural systems using PulTex **SuperStructural** Angles.

Test Set-Up

A double cantilever test setup was designed as displayed below. The design was implemented to maximize the effects of shear and minimize the eccentricity in the connection. Two hinge supports were placed directly below the bolts in the web of the beams; and an identical support was placed at the top of the column beneath the load cell. The steel Wide Flange Section 8 x 31 column used in the connection was loaded in the main stiffness direction.

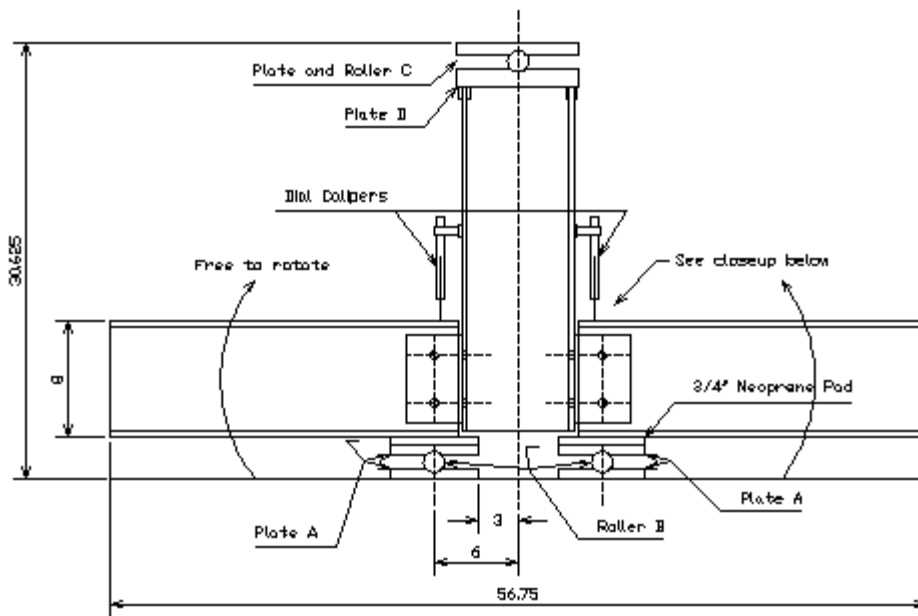

Close up of LVDT

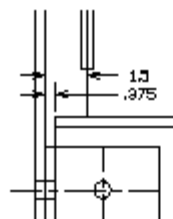

Side view of connection

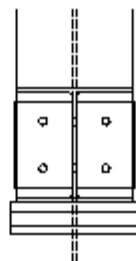

Test Procedure

All hinges were made of steel plates and rollers. The bottom hinges were placed in the line of action of the beam-web bolts to eliminate eccentricity. After the connection was centered on the testing machine a small load of 100 lbs. was applied. The load was applied in increasing increments of 5,000 lbs. at a constant rate of 2,000 lbs. per minute. At every 5,000 lbs., the deflection was recorded. The tests were halted when the load would no longer increase.

Experimental Results

The tests were conducted using 4" x 4" x 3/8" PulTex **SuperStructural** Angles, pultruded in polyester and vinyl ester resins. The angles were clipped into steel beams and columns. The load value recorded from the load cell was divided by 2 to calculate the force transferred to each connection. This computation provided a conservative load estimate because the side that failed first supported more than half the load. The failure mechanism observed was interlaminar peeling and shear through the heel of the angle. The design loads were calculated by dividing the heel area of the angles by half of the total load.

Tests were conducted at the University of Maine by Dr. Roberto Lopez-Anido and Creative Pultrusions' full section testing laboratory.

Appendix B

Computing Modulus (E) and Shear Modulus (G)

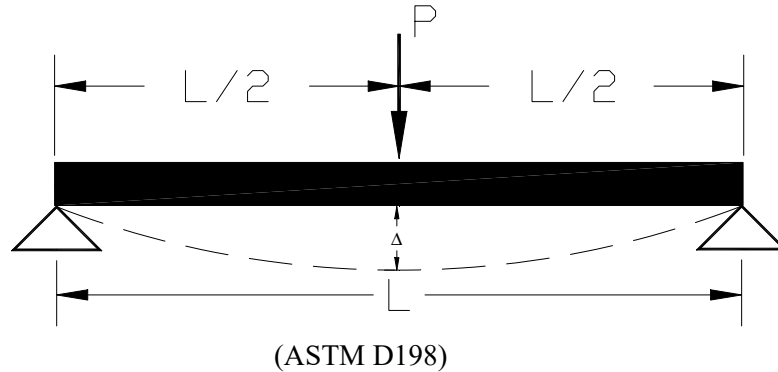

Objective

The Elastic Modulus and the Shear Modulus of a beam can be estimated by using a linear regression analysis of the three-point bending deflection equation and a deflection test as pictured above.

Analysis

The deflection of a simply supported beam with a concentrated center load can be modeled by the following equation:

$$\Delta = \frac{P \cdot L^3}{48 \cdot E \cdot I} + \frac{1}{4K} \cdot \frac{1}{G \cdot A'} \quad (1)$$

where

- Δ = Deflection of the beam at its center
- A' = kA_w (Ref. Table 2)
- A_w = Cross sectional area of web (in²)(Ref. Table 2)
- E = Modulus of elasticity (psi)
- G = Modulus of rigidity (shear modulus) psi
- I_{xory} = Moment of inertia about axis being tested (in⁴)
- k = Shear coefficient (Ref. Table 2)
- L = Span of beam (inches)
- P = Applied load (lbs.)

This equation can be rearranged into the following slope-intercept form:

$$\frac{\Delta}{P \cdot L} = \frac{1}{48} \cdot \frac{1}{E \cdot I} \cdot L^2 + \frac{1}{4} \cdot \frac{1}{G \cdot A'} \quad (2)$$

where

$$SLOPE = \frac{1}{48} \cdot \frac{1}{E \cdot I} \quad (3)$$

and

$$INTERCEPT = \frac{1}{4} \cdot \frac{1}{G \cdot A'} \quad (4)$$

By the method of super position, equation (2) can be split into separate terms and rearranged into the following equations:

$$E \cdot I = \frac{1}{48} \cdot \frac{1}{SLOPE} \quad (5)$$

$$G \cdot A' = \frac{1}{4} \cdot \frac{1}{INTERCEPT} \quad (6)$$

Test the beam at a minimum of three different spans and gather load, span, and deflection data. The graph of $\frac{\Delta}{P \cdot L}$, versus L^2 as displayed, can be produced.

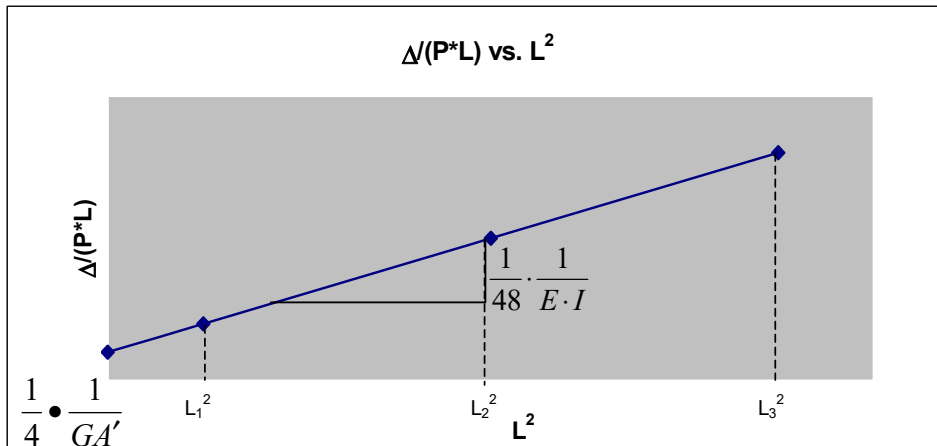

The Apparent Modulus can be calculated by finding the slope of the regression line and plugging it into equation (5). At least three points need to be used in order that test results can be checked for error by calculating the variance of the line. The Shear Modulus can be calculated from the y-intercept of the line and equation (6).

Works Cited

- Bank, L.C. “Flexural and Shear Moduli of Full-Section Fiber Reinforced Plastic (FRP) Pultruded Beams, Journal of Testing and Evaluation.” ITEVA, Vol. 17, No. 1. Philadelphia: 1989.
- Bank, L.C. “Bolted Connections for Pultruded Frame Structures.” Diss. The Catholic University of America, 1996.
- Beer, Ferdinand P., E. Russell Johnston, Jr. Mechanics of Materials. 2nd ed. New York: McGraw-Hill, Inc., 1992.
- Cowper, G.R. “The Shear Coefficient in Timoshenko’s Beam Theory.” National Aeronautical Establishment, National Research Council, Ottawa, Canada, 1966.
- Hibbeler, R.C. Engineering Mechanics Statics and Dynamics. 5th ed. New York: R.C. Hibbeler, 1989.
- Mallick, P.K. Fiber Reinforced Composites Materials, Manufacturing, and Design. 2nd ed. New York: Marcel Dekker, Inc., 1993.
- Salmon, Charles G. and John E. Johnson. Steel Structures Design and Behavior Emphasizing Load and Resistance Factor Design. 3rd ed. New York: Harper & Row, Publishers, Inc., 1990.
- Task Committee on Design of the Structural Plastics Research Council of the Technical Council on Research of the American Society of Civil Engineers. Structural Plastics Design Manual Vol. 1. New York: American Society of Civil Engineers, 1984.
- Task Committee on Design of the Structural Plastics Research Council of the Technical Council on Research of the American Society of Civil Engineers. Structural Plastics Design Manual Vol. 2. New York: American Society of Civil Engineers, 1984.
- Davalos, Julio F., PhD., Barbero, Ever, J., Ph.D., Qiao, Pizhong, Ph.D., P.E. “Step-by-Step Engineering Design Equations for Fiber-reinforced Plastic Beams for Transportation Structures.” Diss. West Virginia Department of Transportation, 1999.

Pultex® Fiberglass Standard Structural Profiles and Superstud!™/Nuts! Product Availability List

All Items are available upon request in standard resin series:																	
Series 1500 = Isophthalic Polyester (I) - Olive Green																	
Series 1525 = Isophthalic Fire Retardant (IFR) - Slate Gray (Dark Gray)																	
Series 1625 = Vinyl Ester Fire Retardant (VFR) - Beige																	
x = Stocked Items (All items stocked in 20' lengths unless otherwise noted.) ♦ = SuperStructural Items																	
Equal Leg Angle					Unequal Leg Angle					I-Beam							
Size (inches)	I	F	V	Mill Run (ft)	Wt. Ft.	Size (inches)	I	F	V	Mill Run (ft)	Wt. Ft.	Size (inches)	I	F	V	Mill Run (ft)	Wt. Ft.
1 x 1/8	x	x		3,000	0.19	4 x 6 x 3/8				700	3.04	3 x 1-1/2 x 1/4♦				1,400	1.22
1 x 1/4				2,500	0.20	4 x 6 x 1/2				700	3.87	4 x 2 x 1/4♦		x		1,300	1.65
1-1/2 x 3/16				2,700	0.29	5 x 10 x 3/8				700	4.47	6 x 3 x 1/4♦	x	x		800	2.49
1-1/2 x 3/16				2,200	0.43	Channel					6 x 3 x 3/8♦		x		800	3.67	
1-1/2 x 1/4	x	x	x	2,000	0.56						8 x 4 x 3/8♦		x	x	600	5.17	
2 x 1/8				2,500	0.39	Channel					8 x 4 x 1/2♦		x		700	6.81	
2 x 3/16				2,000	0.55						10 x 5 x 3/8♦				700	6.43	
2 x 1/4	x	x	x	1,800	0.71	Size (inches)	I	F	V	Mill Run (ft)	Wt. Ft.	10 x 5 x 1/2♦		x		600	8.51
3 x 1/8				2,000	0.59	1-1/2 x 1 x 3/16				2,200	0.45	12 x 6 x 1/2♦				400	10.31
3 x 3/16				1,500	0.86	2 x 9/16 x 1/8		x		2,800	0.30	*Stocked in 25' lengths only.					
3 x 1/4	x	x	x	1,500	1.17	2-3/4 x 1 x 1/8				5,000	0.45						
3 x 3/8	x	x	x	1,200	1.81	3 x 7/8 x 1/4	x	x		1,700	0.81	Wide Flange Beam					
4 x 1/4♦		x	x	1,300	1.56	3 x 1 x 3/16				1,800	0.72						
4 x 3/8♦		x	x	900	2.32	3 x 1-1/2 x 1/4			x	1,300	1.04	Size (inches)	I	F	V	Mill Run (ft)	Wt. Ft.
4 x 1/2♦		x		1,300	3.15	4 x 1-1/16 x 1/8				1,900	0.60	3 x 1/4♦	x	x		1,000	1.85
6 x 1/4♦				900	2.38	4 x 1/8 x 1-3/4 x 3/16		x		1,500	0.90	4 x 1/4♦	x	x	x	800	2.86
6 x 3/8♦	x	x		800	3.57	4 x 1-1/8 x 1/4		x	x	1,200	1.07	6 x 1/4♦		x		700	3.83
6 x 1/2♦		x	x	700	4.74	4-1/2" x 2-1/2" x 1/4"				1,200	1.81	6 x 3/8♦		x	x	600	5.79
*Stocked in NSF 61 Olive Green.						5 x 1-3/8 x 1/4				1,300	1.40	8 x 3/8♦		x		400	7.77
Unequal Leg Angle						6 x 1-5/8 x 1/4		x	x	1,200	1.75	8 x 1/2♦		x		400	10.39
						6 x 1-11/16 x 3/8		x**	x	x	1,000	2.61	10 x 3/8♦				400
Unequal Leg Angle						7 x 2 x 1/4				1,200	2.03	10 x 1/2♦		x		400	12.92
						8 x 2-3/16 x 1/4					1,000	2.42	12 x 1/2♦		x**		300
Unequal Leg Angle						8 x 2-3/16 x 3/8		x	x	800	3.57	*Stocked in 20' and 25' lengths only.					
						10 x 2-3/4 x 1/8					1,500					1.55	
Unequal Leg Angle						10 x 2-3/4 x 1/2		x		600	5.94	**Stocked in 25' lengths only.					
						11-1/2 x 2-3/4 x 1/2♦					600					6.69	
Unequal Leg Angle						1 x 2 x 1/8				2,500	0.22	Round Tube					
						1 x 2 x 3/16					2,000					0.40	
Unequal Leg Angle						1 x 2 x 1/4				2,000	0.53	Size (inches)	I	F	V	Mill Run (ft)	Wt. Ft.
						1 x 3 x 1/8					2,000	0.36	3/4 O.D. x 3/32 Thk.				2,000
Unequal Leg Angle						1-1/4 x 2 x 1/4				1,500	0.58	1 O.D. x 1/8 Thk.	x	x		2,000	0.23
						1-1/2 x 2 x 1/8					2,500	0.37	1-1/4 O.D. x 3/32 Thk.				1,900
Unequal Leg Angle						1-1/2 x 2 x 1/4				1,500	0.63	1-1/4 O.D. x 1/8 Thk.				1,900	0.34
						1-1/2 x 3 x 1/8					2,000	0.39	1-1/2 O.D. x 1/8 Thk.	x	x		1,900
Unequal Leg Angle						1-1/2 x 3 x 3/16				1,500	0.57	1-1/2 O.D. x 1/4 Thk.	x			1,500	0.82
						1-5/8 x 2-5/8 x 1/8					2,500	0.39	1-3/4 O.D. x 1/8 Thk.				1,600
Unequal Leg Angle						2 x 3 x 3/16				1,000	0.70	1-3/4 O.D. x 1/4 Thk.			x	1,500	0.94
						2 x 3 x 1/4					1,500	0.91	2 O.D. x 1/8 Thk.				1,500
Unequal Leg Angle						2 x 3 x 3/8				1,500	1.33	2 O.D. x 1/4 Thk.		x		1,400	1.15
						2 x 4 x 1/4					1,500	1.15	2-1/2 O.D. x 1/8 Thk. ¹				1,500
Unequal Leg Angle						2 x 4 x 3/8				1,000	1.74	2-1/2 O.D. x 1/4 Thk.				1,000	1.35
						3 x 4 x 1/4					1,200	1.37	3 O.D. x 1/8 Thk.				1500
Unequal Leg Angle						3 x 4 x 3/8				1,000	2.10	3 O.D. x 1/4 Thk.				900	1.71
						3-1/2 x 5 x 1/2					1,000	2.96	4.02 O.D. x 0.28 Thk. ²				900
Unequal Leg Angle												Reference Part Drawings for Actual Dimensions. ¹ Part Construction is Special. Consult Factory for Special Properties.					

Square Tube						Solid Round Rod						Special Shapes								
Size (inches)	I	F	V	Mill Run (ft)	Wt. Ft.	Size (inches)	I	F	V	Mill Run (ft)	Wt. Ft.	Size (inches)	I	F	V	Mill Run (ft)	Wt. Ft.			
1 x 1/8	x	x	x ^{***}	1,800	0.34	1/4	x			10,000	0.43	Toe Plate		x [*]	x [*]		2,500	0.54		
1-1/4 x 1/4 ¹				1,000	0.76	3/8	x			5,000	0.94	4 x 1/2 x 1/8						2,500	0.74	
1-1/2 x 1/8	x	x		1,800	0.55	1/2	x			3,500	0.17	6 x 1/2 x 1/8								
1-1/2 x 1/4			x ^{**}	2,500	1.02	5/8				2,400	0.27	Curb Angle								
1-3/4 x 1/8 ¹				2,500	0.56	3/4	x			2,000	0.39	1 x 1-1/2 x 1/4			x ^{**}			1,400	0.91	
1-3/4 x 1/4 ¹			x [†]	1,600	1.12	1	x			1,500	0.69	1-1/2 x 1-1/2 x 1/4			x ^{**}			1,300	1.04	
2 x 1/8	x	x [†]	x [†]	1,600	0.73	1-1/4	x			1,200	1.07	2 x 1-1/2 x 1/4			x ^{**}			1,200	1.11	
2 x 1/4	x ^{***}	x ^{***}	x [*]	1,200	1.50	1-1/2	x			900	1.48									
2-1/8 x 3/16 ¹				1,500	1.23	2				600	2.71	Gate Guide								
2-1/2 x 1/4				1,000	1.87	<i>All Rods Stocked in Natural Color</i>						2-1/2 x 2-1/4 x 1/4						2,500	1.20	
2.47 x 0.220				1,200	1.53	Solid Square Bar						Sludge Flight								
3 x 1/4	x ^{***}	x		800	2.22	Size (inches)	I	F	V	Mill Run (ft)	Wt. Ft.	6 x 1/8 x 2-1/2 x 3/16	x ^{***}					1,000	1.48	
3-1/2 x 3/8				700	3.84	1/4				10,000	0.05	8 x 1/8 x 2-1/2 x 3/16	x ^{***}						1,000	1.68
4 x 1/4		x		700	2.97	1	x			1,400	0.85	U-Trough								
4 x 3/8				1,200	4.46	1-1/4 (1.234" Actual) ¹	x [*]			1,000	1.28	8-1/2 x 9-1/4 x 1/4							1,000	5.32
5.2 x 3/8				700	5.99	1-1/2 (1.460" Actual) ¹	x ^{**}	x [*]		800	1.80	12 x 12 x 1/4							1,000	7.24
6 x 3/8		x		700	7.36	<i>*Stocked in Bright Yellow Only.</i>						4.46lbs								
<i>**Stocked in Dark Gray and Yellow Only.</i>						<i>*Stocked in Yellow Only.</i>						Square Tube with Round Hole								
<i>***Stocked in Dark Gray, Yellow and Beige.</i>						<i>**Stocked in Yellow and Olive</i>						1 x 3/4 dia.								
<i>****Stocked in 20' 1" Lengths Only.</i>						<i>*Reference Part Drawings for Actual Dimensions</i>						<i>† Stocked in 20' 4" Bright Yellow Only.</i>								
<i>* Stocked in Dark Gray and Bright Yellow Only.</i>						Flat Strip						<i>**Stocked in 1525 Light Gray and 1625 Beige Only.</i>								
<i>† Stocked in 20' 4" Bright Yellow Only.</i>						Size (inches)	I	F	V	Mill Run (ft)	Wt. Ft.	<i>Call for Availability.</i>								
<i>‡ Reference Part Drawings for Actual Dimensions</i>						1/8 x 2-1/2				10,000	0.24	Door Frame								
Flat Sheet						Size (inches)	I	F	V	Run (Sheets)	Wt. Ft.2	6"								
1/8 x 48 x 96	x	x	x	188	1.18	1/8 x 4		x [*]	x [*]	6,000	0.40	Fully Fluted Ladder Rung								
3/16 x 48 x 96	x			140	1.72	3/16 x 2-1/2		x [*]	x [*]	6,000	0.37	1.25 O.D. x .165								
1/4 x 48 x 96	x [*]	x ^{**}	x	94	2.30	1/4 x 4				3,000	0.77	<i>Note: T-Sections are cut from I-Sections and can be quoted upon request.</i>								
3/8 x 48 x 96	x	x	x	63	3.47	1/4 x 6				2,000	1.16	<i>*Stocked in Bright Yellow Only.</i>								
1/2 x 48 x 96	x	x		47	4.77	1/4 x 9				1,500	1.90	<i>**Stocked in Dark Gray Only.</i>								
5/8 x 48 x 96				40	5.77	3/8 x 3				3,000	0.85	<i>***Stocked in NSF 61 White Only.</i>								
3/4 x 48 x 96				30	7.49	3/8 x 6				1,500	1.62	<i>* Stocked in NSF Light Gray Only.</i>								
1 x 48 x 96				20	9.46	1/2 x 2		x ^{**}		3,000	0.80	<i>** Stocked in 1525 Light Gray and 1625 Beige Only.</i>								
<i>*Stocked in NSF Olive Green 8' and 12' 2" Lengths.</i>						<i>Note: Many other Flat Strips are available. Consult factory for other sizes</i>						<i>Call for Availability.</i>								
<i>**Stocked in Light Gray and Slate Gray.</i>						<i>*Stocked in Bright Yellow Only.</i>						<i>Call for Availability.</i>								
<i>***Stocked in 10' Lengths Only.</i>						Superstud™/Nuts!														
Rectangular Tube						Size (inches)	I	F	V	Mill Run (ft)	Wt. Ft.	Superstud™	Wt. Ft.	Nuts/Hexnuts	Wt. Ft. (Hex nuts)					
1-1/4 x 3/4 x 1/8 ¹					1,700	0.30	3/8 - 16 UNC	x	0.10	x	0.55	0.45	1/2 - 13 UNC	x	0.17	x	1.10	0.90		
4x1/8 x1-3/4 x 1/4 ¹					2,000	1.38	5/8 - 11 UNC	x	0.27	x	1.00	0.90	3/4 - 10 UNC	x	0.39	x	1.25	1.25		
4-7/16 x 1-7/16 x 1/8 ¹					2,500	1.10	1 - 8 UNC	x	0.68	x	1.35	1.30	<i>Superstud™ is stocked in 96" lengths and is made with Series 1625 VFR resin. Will cut to 48" lengths, no charge.</i>							
4-3/4 x 1-3/4 x 1/8 ¹					2,500	1.36	<i>Isoplast™ Flanged Hex Nuts are also stocked in all sizes. Please specify square or hex nuts when ordering.</i>						Creative Composites Group reserves the right to edit and modify literature, please consult the web site for the most current version of this document.							
5 x 2 x 1/8 ¹					2,500	1.53														
6 x 2 x 1/8 * ¹					2,000	1.92														
8 x 1 x 3/32 * ¹					1,000	1.76														
<i>* Shapes contain internal webs.</i>																				
<i>†Reference Part Drawings for Actual Dimensions.</i>																				
Rectangular Box Beams						Size (inches)	I	F	V	Mill Run (ft)	Wt. Ft.									
6 x 4 x 1/4					1,000	3.87														
7 x 4 x 1/4					1,000	4.09														
7 x 4 x 3/8					800	6.21														
8 x 4 x 1/4					1,000	4.70														
8 x 4 x 3/8					800	6.71														



Creative Composites Group

814-839-4186

214 Industrial Lane
Alum Bank, PA 15521

CreativeCompositesGroup.com

CPS034IMP-0404.5C
DLR10082024
©2024 Creative Composites Group
All Rights Reserved Worldwide