

Channel-Type Instrumentation Tray

Enduro channel-type instrumentation tray is designed for light loads of individual wiring and pneumatic tubing. As illustrated, it is offered in solid or ventilated construction.

Ventilated channel-type tray has .75" (19mm) diameter holes on 9.25" (235mm) or 12" (305mm) centers staggered left and right in the web.

All straight sections and pre-assembled fittings are pre-drilled to accept flange splice plates. All splice plates and hardware are separate order items.

Part Numbers - Polyester Resin System, Solid Bottom

Part No. Key*	Channel Size Width x Depth	Wt./Ft.
EIS-200 x (L)	2" x 1" (51 x 25)	0.35
EIS-300 x (L)	3" x 1" (76 x 25)	0.68
EIS-400 x (L)	4" x 1 1/8" (102 x 35)	0.94
EIS-600 x (L)	6" x 1 1/8" (152 x 35)	1.34
EIS-600D x (L)	6" x 2" (152 x 51)	1.5
EIS-800 x (L)	8" x 1 3/4" (203 x 35)	2.60
EIS-1000 x (L)	10" x 2 3/4" (254 x 70)	4.10

Width represents outside dimensions.

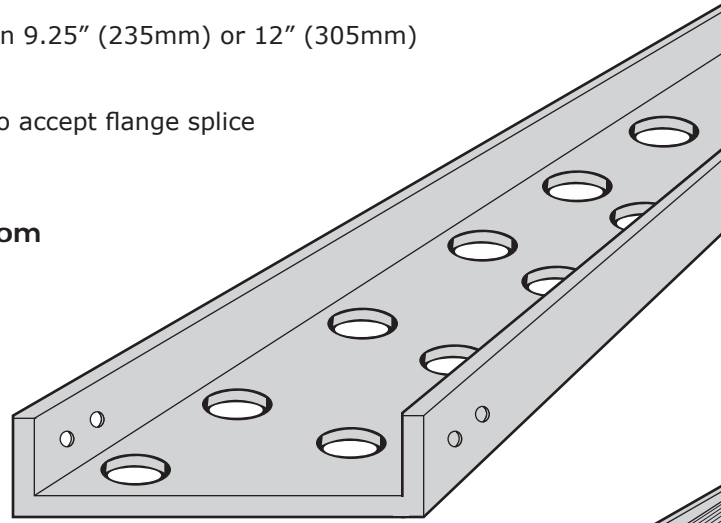

Part Numbers - Other Resin Systems, Solid Bottom

Part No. Key*	Resin System
EIS-VE-200 x (L)	Vinyl Ester
EIS-S-200 x (L)	Poly Halogen-Free
Contact Us	VE Halogen-Free
EIS-Y-200 x (L)	Halogen-Free Low Smoke Plus
EIS-RT-200 x (L)	Conductive

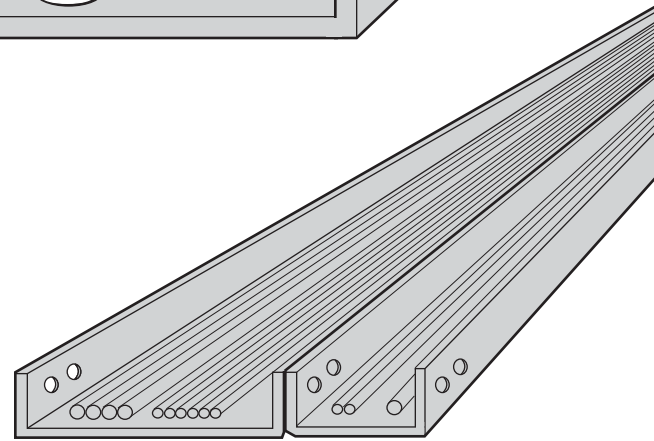

For ventilated tray, replace the "S" in the part number with a "P".

L = Length; Available in 10', 20', 3m, and 6m sections, substitute "L" for 10, 20, 3M, or 6M.

Examples: EIS-400 x 10
EIS-400 x 3M

Technical Data - Channel-Type Instrumentation Tray

Maximum Loading & Maximum Deflection

Part No.	Span	Max Loading	Max Deflection
	ft. (m)	Lbs./ft. (N/m)	In. (mm)
EIS-200 x (L)	5 (1.5)	4.0 (5.94)	0.5 (12.7)
	8 (2.4)	1.0 (1.48)	0.8 (20.3)
EIS-300 x (L)	5 (1.5)	3.9 (5.79)	0.5 (12.7)
	8 (2.4)	1.0 (1.48)	0.8 (20.3)
EIS-400 x (L)	8 (2.4)	2.8 (4.16)	0.8 (20.3)
	10 (3.0)	1.5 (2.23)	1.0 (25.4)
EIS-600 x (L)	10 (3.0)	2.8 (4.16)	1.0 (25.4)
EIS-800 x (L)	10 (3.0)	5.2 (7.73)	1.0 (25.4)
EIS-1000 x (L)	10 (3.0)	20.0 (29.73)	1.0 (25.4)
	15 (4.5)	3.9 (5.79)	1.0 (25.4)

Loads are based on limiting the deflection to a value equal to 1/120 of the span.

For ventilated tray, max loading reduced by 10%.

* In Part No. Key, parentheses () = insert corresponding option code; (L) = Length, see note above

Channel-Type Inst. Tray - Fittings & Accessories

The following fitting part numbers are for polyester, solid bottom channel-type fittings. Molded fittings also available in vinyl ester, add "VE", in halogen-free, add "S", and in conductive, add "RT". Vinyl ester example: EIS-VE-MC90IV-18-600. Mitered fittings also available in vinyl ester, add "VE" Example: EIS-90IV-12-600 and also available in halogen-free low smoke plus, add "Y" Example: EIS-Y-90IV-12-600. For ventilated fitting, replace the "S" with a "P".

90° Vertical Inside Molded

Part No.	Radius	A
EIS-MC90IV-18-600	18" (457)	22 ³ / ₄ " (578)
EIS-MC90IV-24-400	24" (610)	28 ¹ / ₁₆ " (729)
EIS-MC90IV-24-600	24" (610)	28 ³ / ₄ " (730)

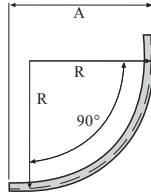

90° Vertical Outside Molded

Part No.	Radius	A
EIS-MC90OV-12-600	12" (305)	16 ¹ / ₄ " (413)
EIS-MC90OV-24-400	24" (610)	28 ⁵ / ₁₆ " (719)
EIS-MC90OV-24-600	24" (610)	28 ¹ / ₂ " (718)
EIS-MC90OV-24-800	24" (610)	28 ³ / ₁₆ " (716)

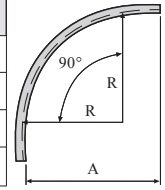

90° Horizontal Molded

Part No.	Radius	A
EIS-MC90HB-12-600	12" (305)	22 ³ / ₄ " (578)
EIS-MC90HB-24-400	24" (610)	32 ¹³ / ₁₆ " (833)
EIS-MC90HB-24-600	24" (610)	34 ³ / ₄ " (883)
EIS-MC90HB-24-800	24" (610)	36 ¹ / ₁₆ " (932)

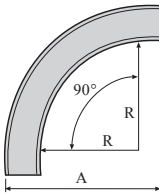

90° Vertical Inside Mitered

Part No. Key*	A
EIS-90IV-(R)-(W)00	22 ¹ / ₄ " (565)
EIS-90IV-(R)-(W)00	34 ¹ / ₄ " (820)

R = Radius which can be 12" (305) or 24" (610); W = Width which can be 2", 3", 4", 6", 8" or 10"; For 10" dimensions contact us. Substitute "P" for "S" for punched channel.

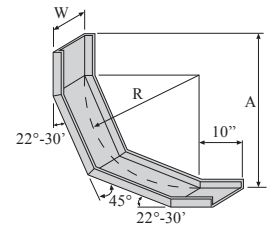

90° Vertical Outside Mitered

Part No. Key*	A
EIS-90OV-(R)-(W)00	22" (559)
EIS-90OV-(R)-(W)00	34" (864)

R = Radius which can be 12" (305) or 24" (610); W = Width which can be 2", 3", 4", 6", 8" or 10"; For 10" dimensions contact us. Substitute "P" for "S" for punched channel.

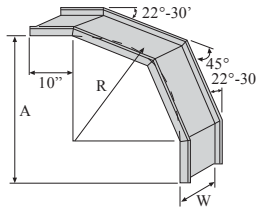

90° Horizontal Bend

Part No.	A
EIS-90HB-12-200	24" (610)
EIS-90HB-12-300	25" (635)
EIS-90HB-12-400	26" (660)
EIS-90HB-12-600	28" (711)
EIS-90HB-12-800	30" (762)
EIS-90HB-12-1000	32" (813)
EIS-90HB-24-200	36" (914)
EIS-90HB-24-300	37" (940)
EIS-90HB-24-400	38" (965)
EIS-90HB-24-600	40" (1016)
EIS-90HB-24-800	42" (1067)
EIS-90HB-24-1000	44" (1118)

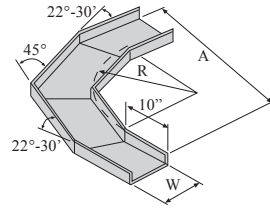

Horizontal Tee & Horizontal Cross

Part No. Key*	W1	W2
EIS-HT or HC-200	2" (51)	2" (51)
EIS-HT or HC-300	3" (76)	3" (76)
EIS-HT or HC-400	4" (102)	4" (102)
EIS-HT or HC-600	6" (154)	6" (152)
EIS-HT or HC-800	8" (203)	8" (203)
EIS-HT or HC-1000	10" (255)	10" (255)

HT = Horizontal Tee; HC = Horizontal Cross; Substitute "P" for "S" for punched channel

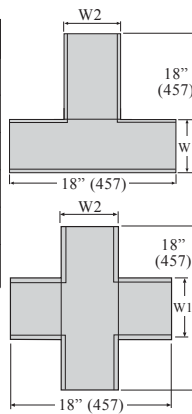

Channel Tray Cover Channel Cover Clamp

Part No. Key*
EPC-(W)00-(Δ)

Δ = Resin - insert "P" for polyester resin, insert "Y" for halogen-free low smoke plus resin. Hardware and clamp not included. For other resin part numbers, contact us.

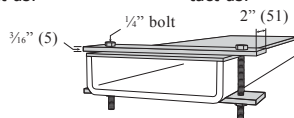

Part No. Key*
CCC-(W)00-(Δ)

Δ = Resin - insert "PE" for polyester resin, insert "Y" for halogen-free low smoke plus resin. 316 SS hardware included. For other resin part numbers, contact us.

Channel Hold Down Clip

Part No.	W	A
IHDC-3	3" (76)	1 ¹ / ₈ " (28)
IHDC-4	4" (102)	1 ¹ / ₄ " (33)
IHDC-6	6" (154)	1 ³ / ₄ " (44)
IHDC-6D	6" (154)	1 ³ / ₄ " (44)
IHDC-8	8" (203)	1 ⁷ / ₈ " (47)
IHDC-10	10" (255)	2 ⁷ / ₈ " (72)

10 Ga. 316 SS

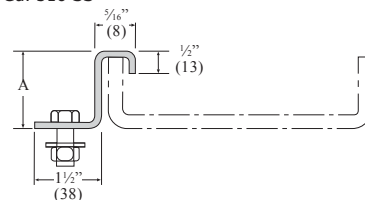

* In Part No. Key, parentheses () = insert corresponding option code; Δ = Resin; R = Radius; W = Width of the inside distance from tray wall to tray wall

Splice Plates - Channel-Type Inst. Tray

Channel-Type Splice Plate Part Numbers

Example: **EISP - 90V - 600**

Degree
 180 = Straight
 90 = 90°
 45 = 45°
 30 = 30°
 22.5 = 22.5°

Direction
 V = Vertical
 H = Horizontal
 (for straight, leave direction space in product number blank, example: EISP-180-600)

Channel Size
 200 = 2" (50mm)*
 300 = 3" (75mm)*
 400 = 4" (100mm)*
 600 = 6" (150mm)*
 800 = 8" (200mm)*
 1000 = 10" (250mm)*

These part numbers are for Polyester resin.

* (mm) values are nominal

Splice plates and hardware are sold individually and are not provided with straight sections or fittings.

For expansion insert "X" between "EISP" and Degree, example: EISP-X-180-200.

For Vinyl Ester Resin, add "VE"
 Example: EISP-VE-90V-600

For Halogen-Free Polyester Resin, add "HS" - Example EISP-HS-90V-600

For Stainless Steel, add "316SS"
 Example: EISP-90V-600-316SS

For Halogen-Free VE and Halogen-Free Low Smoke Plus, contact us.

Dimensions

Channel Depth Inches (mm)	A Inches (mm)
2 (51)	1 (25)
3 (76)	1 (25)
4 (102)	1 (25)
6 (152)	1 1/4 (32)
8 (203)	1 1/4 (32)
10 (254)	2 1/4 (57)

Hardware

Part No.	Size
505139SS	1/4" - 20 x 3/4"
505141SS	1/4" - 20 x 1"

Set includes bolt, nut and 2 flat washers. Each plate requires 4 sets of fasteners.

Part No. 505141SS for EIS-800 channel tray only. Contact us for bolt sets for 10" channel.

Straight Section

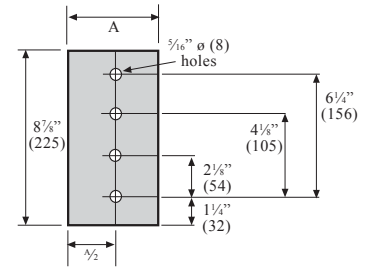

Expansion

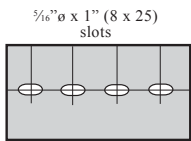

90° Vertical

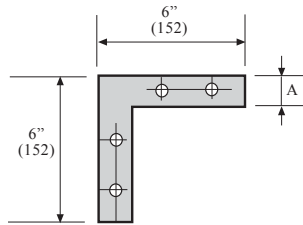

45° Vertical

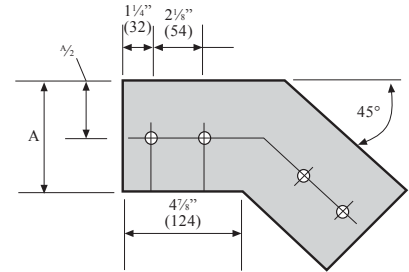

30° Vertical

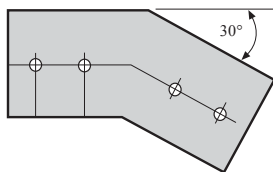

22.5° Vertical

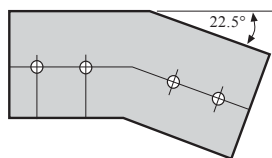

90° Horizontal

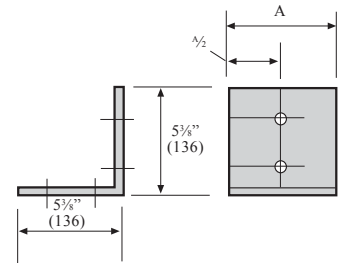

45° Horizontal

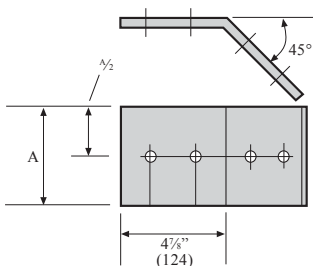

30° Horizontal

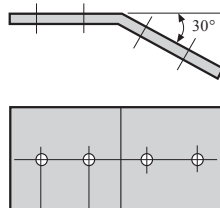

22.5° Horizontal

