

Lasting Solutions for
Challenging Conditions

composites
enduro

FRP Strut and Framing Accessories

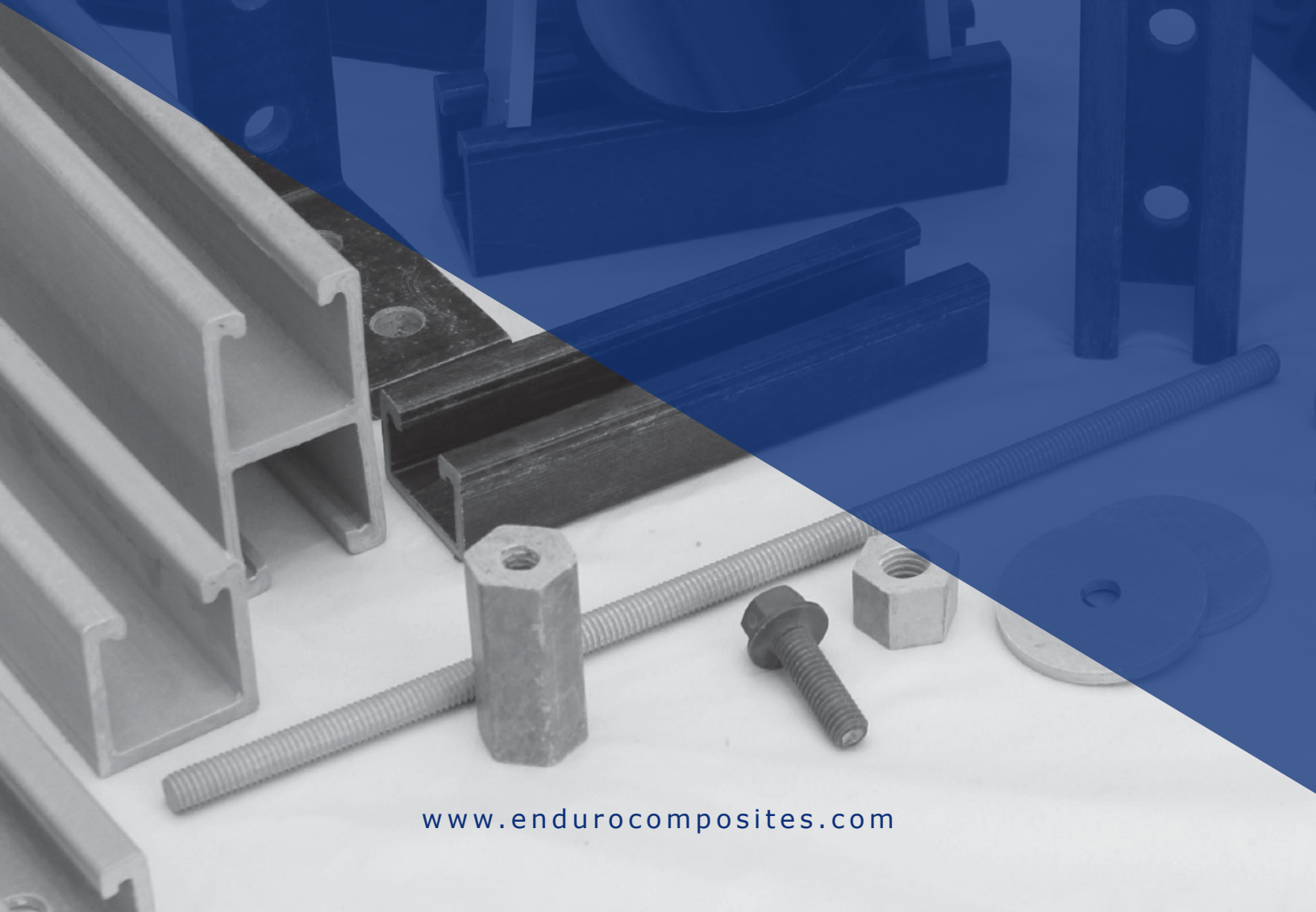

Welcome to composites enduro

This product catalog and guide provides the information you need to design your structural support and strut solution.

Should you need additional information, feel free to contact us at (800) 231-7271 or at sales@endurocomposites.com. Please also visit our website at endurocomposites.com.

Thank you for your interest and we look forward to working with you.

Table of Contents

3	FRP/GRP Technical Data
5	Channel Framing
6	Connector Plates
7	Post Bases, Clevis Hangers & More
8	Typical Installations & Specification
9	Fastener & Hanging Systems
11	Instrument & Pushbutton Stands

Typical Properties of Structural FRP/GRP

Longitudinal Direction

Mechanical (coupon)	FR-P	FR-VE
Ultimate Tensile Strength, PSI (ASTM D638)	30,000	35,000
Ultimate Compressive Strength, PSI (ASTM D695)	30,000	35,000
Ultimate Flexural Strength, PSI (ASTM D790)	30,000	35,000
Tensile Modulus, PSI x 10 ⁶	2.5	3.0
Compressive Modulus, PSI x 10 ⁶	2.5	2.5
Flexural Modulus, PSI x 10 ⁶	1.6	2.0
Ultimate Shear Strength, PSI	5,500	7,000
Ultimate Bearing Stress, PSI	30,000	35,000
Izod Impact Strength, Ft.-Lbs. per inch of notch (ASTM D256) (sample thickness 1/8" except 1/4" for rod)	25	30

Transverse Direction

Mechanical (coupon)	FR-P	FR-VE
Ultimate Tensile Strength, PSI	7,000	10,000
Ultimate Compressive Strength, PSI	15,000	20,000
Ultimate Flexural Strength, PSI	10,000	14,000
Tensile Modulus, PSI x 10 ⁶	0.8	1.0
Compressive Modulus, PSI x 10 ⁶	1.0	1.2
Flexural Modulus, PSI x 10 ⁶	0.8	1.0
Ultimate Shear Strength, PSI	5,500	6,000
Ultimate Bearing Stress, PSI	30,000	35,000
Izod Impact Strength, Ft.-Lbs. per inch of notch (ASTM D256)	4	5
Barcol Hardness (ASTM D2583-75)	50	50

Electrical

Mechanical (coupon)	FR-P	FR-VE
Electric Strength, short term in oil, 1/8", vpm (ASTM D149)*	200	200
Electric Strength, short term in oil, KV per inch	35	35
Dielectric Constant, 60 Hz.(ASTM D150)*	5.6	5.2
Dissipation Factor, 60 Hz. (ASTM D150)*	0.03	0.03
Arc Resistance, seconds (ASTM D495)**	120	120

Full Section in Bending

Mechanical (coupon)	FR-P	FR-VE
Modulus of Elasticity, PSI x 10 ⁶	2.5	3.0
Tensile Strength, PSI	20,000	25,000
Compressive Strength, PSI	20,000	25,000

Fire Retardant Properties

Mechanical (coupon)	FR-P	FR-VE
Flame Resistance, ign/burn, seconds (FTMS 406-2023)	75/75	75/75
Intermittent Flame Test, rating (HLT-15)	100	100
Flammability Test	average time of burning 5 seconds, average extent of burning 15mm (ASTM D635)	
Surface Burning Characteristics, maximum (ASTM E84)	25	25

Thermal

Mechanical (coupon)	FR-P	FR-VE
Thermal Coefficient of Expansion Inches/Inch/°F (ASTM D696)**	5 x 10 ⁻⁶	5 x 10 ⁻⁶
Thermal Conductivity, BTU per Sq. Ft./Ht./°F/In. (ASTM C-177-76)	4	4
Specific Heat, BTU/Lb./°F	0.28	0.28

Other

Mechanical (coupon)	FR-P	FR-VE
Density, Lbs./In. ³ (ASTM D792)	0.065	0.065
Specific Gravity (ASTM D792)	1.80	1.80
Water Absorption, Max. % by weight (24 hour immersion) (ASTM D570)	.50	.50

Note: 1 PSI = 6.894 K Pa; 1 Ft.-Lb./In. = 5.443 kg-m/m; * Specimen tested perpendicular to laminate face ** Indicates reported value measured in longitudinal direction; Depending on the specific glass content and resin, the strength and stiffness properties may be significantly higher. Contact us for specific values on Halogen-Free Low Smoke Plus resin properties.

Concentric Static Load (if required)

User applications may require that a given concentrated static load be imposed over and above the working load. Such concentrated static load represents a static weight applied between the side rail at midspan. When so specified, the concentrated static load may be converted to an equivalent load (W_e) in pounds per linear foot (kg/m) using the formula to the below right and added to the static weight of cable in the tray. This combined load may be used to select a suitable load/span designation.

If the combined load exceeds the working load shown, please contact us. This data was obtained from the NEMA and NEC Standards Publications and other sources to assist in the proper selection of the most appropriate cable tray type offered by Enduro.

$$W_e = \frac{2 \times (\text{Concentrated Static Load})}{\text{span length (ft or m)}}$$

Thermal Contraction & Expansion

The table to the right compares the thermal contraction and expansion based on various temperature differentials for fiberglass, steel and aluminum cable trays. The values shown represent the length of cable tray that will produce a 5/8" movement between expansion connectors for the indicated temperature differential. Fiberglass has the least movement. Enduro has expansion connectors to provide for total movement of 5/8".

Fiberglass vs Steel vs Aluminum

Temp. Differential	Fiberglass Ft. (m)	Steel Ft. (m)	Aluminum Ft. (m)
25°F (14°C)	417 (126)	320 (97)	162 (49)
50°F (28°C)	208 (63)	160 (48)	81 (25)
75°F (42°C)	138 (42)	106 (32)	54 (16)
100°F (56°C)	104 (32)	80 (24)	40 (12)
125°F (69°C)	83 (25)	63 (19)	32 (10)
150°F (83°C)	69 (21)	53 (16)	26 (8)
175°F (97°C)	59 (17)	45 (13)	23 (6)

FRP/GRP Technical Data

Effect of Temperature - FRP/GRP

Strength properties of reinforced plastics are reduced when continuously exposed to elevated temperatures. Working loads shall be reduced when based on the table to the right. Percentages shown are approximate. If unusual temperature conditions exist, please contact us for consultation. Below freezing temperatures do not adversely affect the load rating capability of the tray. Fiberglass does not become brittle at below freezing temperatures. Careful review should be made of applications involving service temperatures over 200°F.

Temp.	Polyester Strength %	Vinyl Ester Strength %
75°F (24°C)	100%	100%
100°F (38°C)	90%	100%
125°F (52°C)	78%	100%
150°F (66°C)	68%	90%
175°F (79°C)	60%	90%
200°F (93°C)	52%	75%

The test values in the chart below were obtained from tests conducted by Enduro's vinyl ester resin supplier. The values shown, although obtained from an actual coupon test, are intended for illustrative purposes only, and not for use in design calculations. The values for polyester are slightly lower.

Test Temp. °F (°C)	-100° (-73°)	-50° (-46°)	0° (-18°)	50° (10°)	77° (25°)	100° (38°)	150° (66°)	200° (93°)	250° (121°)	300° (149°)
Flex. St., PSI, ASTM D790	101,500	86,400	79,500	72,300	68,100	66,300	58,700	27,400	13,200	9,200
Flex. Mod., PSI x 10 ⁶ , ASTM D790	3.36	3.32	3.42	3.38	3.24	3.29	3.07	1.98	0.98	0.83
Tensile St., PSI, ASTM D638	84,100	70,400	63,900	58,000	56,100	54,600	49,900	41,800	29,600	22,000

Corrosion Resistance of Resin Systems

Enduro offers a variety of resin systems. The two resin systems most often used are isophthalic polyester fire-retardant (FR-P) and vinyl ester fire-retardant (FR-VE). Polyester is more widely used and sufficient for most applications while vinyl ester is recommended where strong acids (such as hydrochloric acid), strong alkalies (such as caustic soda), organic solvents and organic conditions exist. An abbreviated guide is provided below to assist in the selection of the proper standard resin system for individual application.

Polyester and vinyl ester resin systems are available in conductive formulation. Contact us for corrosion resistance information for halogen-free and halogen-free low smoke plus resins.

All composite materials have an ultra-violet light inhibiting chemical additive and has a maximum flame spread of 25 or less, per ASTM E-84 (Class 1 flame spread). All pultruded products have complete synthetic veil coverage (outer surfacing fabric) to provide maximum chemical and UV protection.

Chemicals	75°F (24°C)	160°F (71°C)	Chemicals	75°F (24°C)	160°F (71°C)
Acetic Acid 5%	FR-P	FR-P	Magnesium Chloride	FR-P	FR-P
Acetic Acid 25%	FR-P	FR-VE-210° (*)	Methyl Alcohol 10%	FR-P	FR-VE-150° (*)
Aluminum Potassium Sulfate 5%	FR-P	FR-P	Naphtha	FR-P	FR-P
Ammonium Hydroxide 10%	FR-P	FR-VE-150°	Nitric Acid 5%	FR-P	FR-P
Ammonium Nitrate	FR-P	FR-P	Nitric Acid 20%	FR-VE	FR-VE-120° (*)
Benzenesulfonic Acid 5%	FR-P	FR-P	Phosphoric Acid 10%	FR-P	FR-P
Calcium Chloride	FR-P	FR-P	Phosphoric Acid 30%	FR-P	FR-P
Carbon Tetrachloride	FR-VE	FR-VE-100° (*)	Phosphoric Acid 85%	FR-P	FR-P
Chlorine Dioxide 15%	FR-P	FR-VE-150° (*)	Sodium Bicarbonate 10%	FR-P	FR-P
Chromic Acid 5%	FR-P	FR-VE-150° (*call)	Sodium Bisulfate	FR-P	FR-P
Copper Sulfate	FR-P	FR-P	Sodium Carbonate	FR-P	FR-VE
Diesel Fuel No. 1	FR-P	FR-P	Sodium Chloride	FR-P	FR-P
Diesel Fuel No. 2	FR-P	FR-P	Sodium Hydroxide 1-50%	FR-VE	FR-VE-120° (*)
Ethylene Glycol	FR-P	FR-P	Sodium Hypochlorite 5%	FR-P	FR-VE-120° (*)
Fatty Acids 100%	FR-P	FR-P	Sodium Nitrate	FR-P	FR-P
Ferrous Sulfate	FR-P	FR-P	Sodium Silicate	FR-P	FR-VE-210° (*)
Fluosilicic Acid 0-20%	FR-VE	FR-VE (call)	Sodium Sulfate	FR-P	FR-P
Hydrochloric Acid 1%	FR-P	FR-P	Sulfuric Acid 0-30%	FR-P	FR-P
Hydrochloric Acid 15%	FR-P	FR-VE-180° (*)	Sulfuric Acid 30-50%	FR-VE	FR-VE
Hydrochloric Acid 37%	FR-P	FR-VE-150° (*)	Sulfuric Acid 50-70%	FR-VE	FR-VE-180° (*)
Hydrogen Sulfide	FR-P-140°	FR-VE-210°	Trisodium Phosphate 25%	FR-P	FR-VE-210° (*)
Kerosene	FR-P	FR-P	Trisodium Phosphate - All	FR-VE	FR-VE-210° (*)
			Water, Distilled	FR-P	FR-P

FR = Fire-Retardant; P = Polyester Resin; VE = Vinyl Ester Resin; (*) = Not recommended to exceed this temperature; call = Call for recommendations
 Information contained in this chart is based on data from raw material suppliers and collected from several years of actual industrial applications. Temperatures are not the minimum nor the maximum (except where specifically stated) but represent standard test conditions. The products may be suitable at higher temperatures, but individual test data should be required to establish such suitability. The recommendations or suggestions contained in this chart are made without guarantee or representation as to results. We suggest that you evaluate these recommendations and suggestions in your own laboratory or by actual field trial prior to use.

Support Systems & Strut

Channel Framing (Solid & Punched)

Part No.	Lbs./Ft.
Polyester: EC-10	0.47
Vinyl Ester: EC-VE-10	

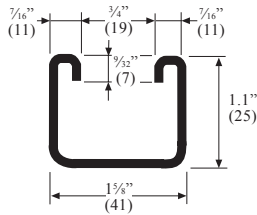

Part No.	Lbs./Ft.
Polyester: EC-158	0.68
Vinyl Ester: EC-VE-158	

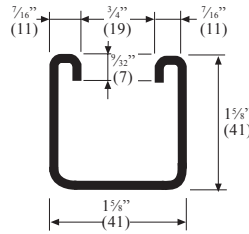

Part No.	Lbs./Ft.
Polyester: EC-158D	1.36
Vinyl Ester: EC-VE-158D	

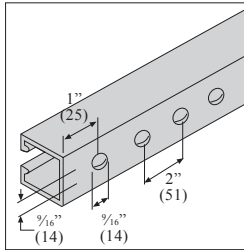
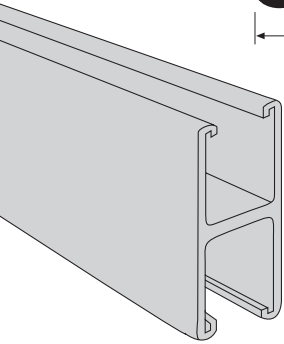
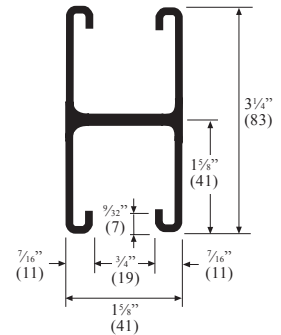

For punched channel framing add "H" to the end of the part number; example: EC-10H. Punched not available for double channel. Punched holes are 9/16" holes on 2" centers. Replaces drilled strut.

For use in tray support systems, electrical conduit and tray rungs for tying down cable. Available in 10 ft and 20 ft lengths. See below for loading.

Technical Data - Support Systems & Strut

Channel Framing Loading

Beam and Column Data: Polyester and Vinyl Ester Resin Base

Beam Span or Column Height In.(mm)	Part No.	Maximum Allowable Uniform Beam Load		Deflection @ Maximum Allowable Uniform Beam Load		Uniform Load @ Maximum Deflection = 0.25 In. (6mm)		Uniform Load @ Maximum Deflection = 0.50 In. (13mm)		Maximum Allowable Column Load Lbs.(kg)
		Poly Lbs.(kg)	Vinyl Lbs.(kg)	Poly In.(mm)	Vinyl In.(mm)	Poly Lbs.(kg)	Vinyl Lbs.(kg)	Poly Lbs.(kg)	Vinyl Lbs.(kg)	
12" (305)	EC-10	790 (358)	990 (449)	0.11 (3)	0.12 (3)	-	-	-	-	2550 (1156)
	EC-158	1720 (780)	2150 (975)	0.07 (2)	0.07 (2)	-	-	-	-	3650 (1655)
	EC-158D	5080 (2301)	6350 (2880)	0.04 (1)	0.04 (1)	-	-	-	-	7300 (3311)
18" (457)	EC-10	530 (240)	670 (304)	0.24 (6)	0.27 (7)	-	620 (281)	-	-	2350 (1066)
	EC-158	1150 (521)	1440 (653)	0.15 (4)	0.17 (4)	-	-	-	-	3370 (1528)
	EC-158D	5080 (2301)	4240 (1923)	0.09 (2)	0.10 (2)	-	-	-	-	6740 (3058)
24" (610)	EC-10	400 (181)	500 (227)	0.43 (11)	0.48 (12)	240 (109)	270 (122)	-	-	2070 (939)
	EC-158	860 (390)	1080 (490)	0.27 (7)	0.30 (8)	810 (367)	910 (412)	-	-	2960 (1342)
	EC-158D	2540 (1152)	3180 (1442)	0.16 (4)	0.17 (4)	-	-	-	-	5920 (2685)
30" (762)	EC-10	320 (145)	400 (181)	0.67 (17)	0.75 (19)	120 (54)	140 (63)	240 (109)	270 (122)	1710 (775)
	EC-158	690 (313)	870 (394)	0.42 (11)	0.48 (12)	410 (186)	460 (209)	-	-	2450 (1111)
	EC-158D	2040 (925)	2550 (1156)	0.24 (6)	0.27 (7)	2000 (907)	2350 (1066)	-	-	4900 (2222)
36" (914)	EC-10	270 (122)	340 (154)	0.98 (25)	1.10 (28)	70 (31)	80 (36)	140 (63)	160 (72)	1260 (571)
	EC-158	580 (263)	730 (331)	0.61 (15)	0.69 (19)	240 (109)	270 (122)	480 (217)	540 (245)	1800 (816)
	EC-158D	1700 (771)	2130 (966)	0.35 (9)	0.39 (10)	1220 (553)	1370 (621)	-	-	3600 (1633)
42" (1067)	EC-10	230 (104)	290 (131)	1.32 (34)	1.49 (38)	50 (22)	55 (25)	100 (45)	115 (52)	920 (417)
	EC-158	490 (222)	620 (281)	0.82 (21)	0.92 (23)	150 (68)	170 (77)	300 (136)	340 (154)	1320 (598)
	EC-158D	1460 (662)	1830 (830)	0.48 (12)	0.62 (16)	770 (349)	870 (394)	1510 (650)	1720 (530)	2640 (1197)
48" (1219)	EC-10	200 (91)	250 (113)	1.72 (44)	1.92 (49)	30 (13)	25 (16)	60 (27)	70 (31)	700 (317)
	EC-158	430 (195)	540 (245)	1.07 (27)	1.20 (30)	100 (45)	115 (52)	200 (90)	230 (104)	1010 (458)
	EC-158D	1270 (576)	1590 (721)	0.62 (16)	0.69 (17)	520 (236)	590 (267)	1040 (471)	1170 (780)	2020 (916)
60" (1524)	EC-10	160 (72)	200 (91)	2.68 (68)	2.99 (76)	20 (9)	23 (10)	40 (18)	45 (20)	180 (81)
	EC-158	350 (158)	400 (200)	1.70 (43)	1.91 (48)	60 (27)	70 (32)	120 (54)	135 (61)	260 (118)
	EC-158D	1020 (462)	1280 (580)	0.97 (25)	1.09 (28)	270 (122)	310 (140)	540 (245)	610 (276)	520 (235)
72" (1829)	EC-10	140 (63)	180 (81)	*	*	10 (4)	12 (5)	20 (9)	23 (10)	-
	EC-158	290 (131)	370 (168)	2.44 (62)	2.78 (71)	30 (13)	34 (15)	60 (27)	70 (32)	-
	EC-158D	850 (385)	1070 (485)	1.40 (35)	1.57 (40)	160 (72)	180 (81)	320 (145)	360 (163)	-
84" (2134)	EC-10	120 (54)	150 (68)	*	*	NR	-	12 (5)	15 (7)	-
	EC-158	250 (113)	320 (145)	*	*	20 (9)	23 (10)	40 (18)	45 (20)	-
	EC-158D	730 (331)	920 (417)	1.91 (48)	2.15 (55)	100 (45)	115 (52)	200 (90)	230 (104)	-
96" (2438)	EC-10	100 (45)	130 (59)	*	*	NR	-	-	-	-
	EC-158	220 (100)	250 (113)	*	*	13 (6)	15 (7)	26 (12)	30 (13)	-
	EC-158D	640 (290)	800 (363)	2.50 (63)	2.79 (71)	70 (32)	80 (36)	140 (63)	160 (72)	-

* Deflection is in excess of 3.00 in. (76mm); mid-span support is recommended. NR = Not Recommended; **Beam Loads:** Table lists the total allowable load for various simple spans based on a minimum safety factor 2:1. If load is concentrated at center of span, multiply the load from the table by 0.5 and the corresponding deflection by 0.8. **Column Loads:** Table lists the total allowable axial load for various unsupported column heights based on a minimum safety factor of 3:1. Eccentric loads should be reduced according to standard practice.

Notes: All beams should be supported in a manner to prevent rotation at supports. Long, deep beams should be tied between supports to prevent twist.

Support Systems & Strut

Connector Plates

Based on individual applications, changes may be required on dimension and thickness of material. Please contact us. Holes are drilled to accept 3/8" and 1/2" bolts. For Vinyl Ester Connector Plates, insert the letters "VE" as indicated in this example: Polyester = CP-100; Vinyl Ester = CP-VE-100

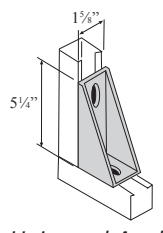

Universal Angle
SEE NOTE AT BOTTOM

Part No.
Polyester: CP-501
Polyurethane: CP-PU-501
Nylon: CP-NY-501

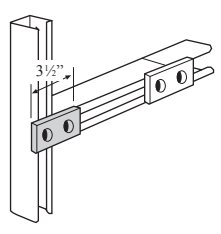

Part No.
CP-100

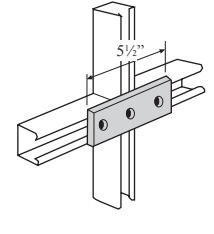

Part No.
CP-101

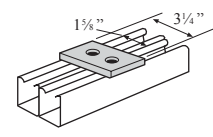

Part No.
CP-102

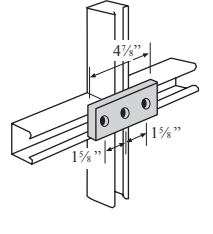

Part No.
CP-103

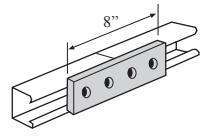

Part No.
CP-104

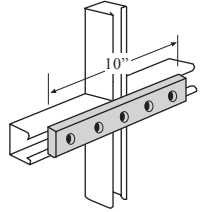

Part No.
CP-105

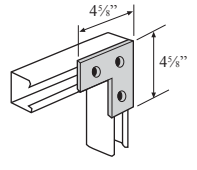

Part No.
CP-109

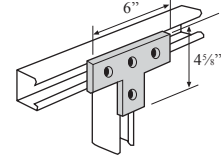

Part No.
CP-110

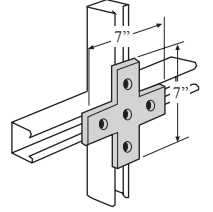

Part No.
CP-111

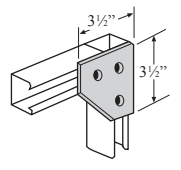

Part No.
CP-112

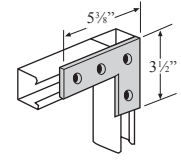

Part No.
CP-113

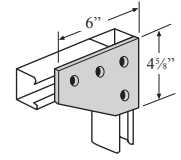

Part No.
CP-114

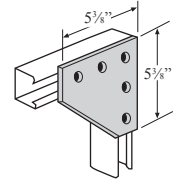

Part No.
CP-115

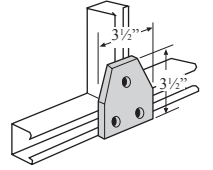

Part No.
CP-116

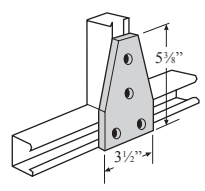

Part No.
CP-117

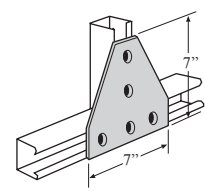

Part No.
CP-118

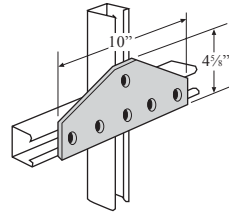

Part No.
CP-119

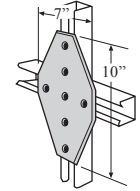

Part No.
CP-120

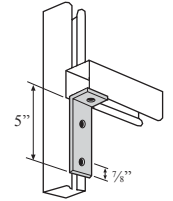

Note: Flat washer not required for CP-205

Part No.
CP-205

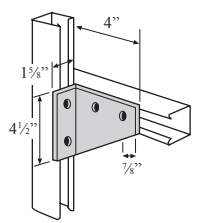

SEE NOTE AT BOTTOM
Part No.
CP-209

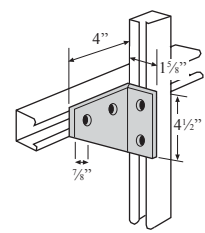

SEE NOTE AT BOTTOM
Part No.
CP-210

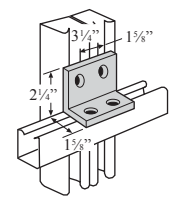

SEE NOTE AT BOTTOM
Part No.
CP-211

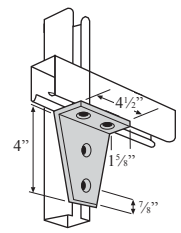

SEE NOTE AT BOTTOM
Part No.
CP-226

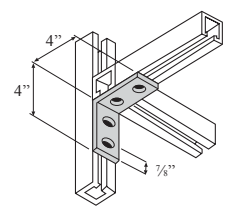

SEE NOTE AT BOTTOM
Part No.
CP-405

NOTE: These composite angle components will not support tensile loads or forces.

Support Systems & Strut

Post Base

Part No.
Polyester: PBD-PE
Polyurethane: PBD-PU

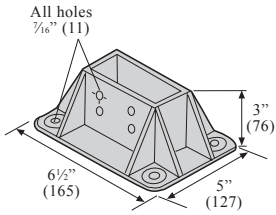

Part No.
Polyester: PBS-PE
Polyurethane: PBS-PU

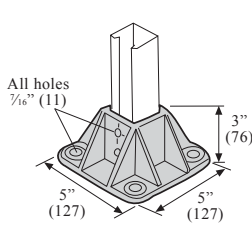

Window Clamp

Part No.
WC-158

Stainless steel set screw included

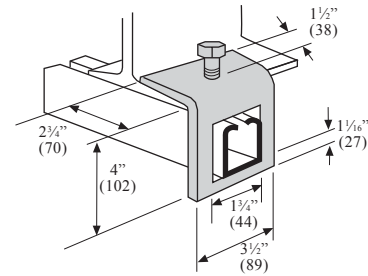

Clevis Hanger

Part No.	Pipe Size	Hanger O.D.	Hanger Rod Dia.
CH-010	3/4" to 1"	2.53"	3/8"
CH-015	1 1/4" to 1 1/2"	3.06"	1/2"
CH-020	2"	3.68"	1/2"
CH-025	3" to 4"	7.04"	1/2"
CH-030	6"	9.36"	1/2"

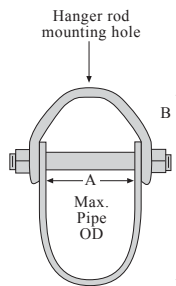

Polyurethane (PU) resin is the standard. Allowable loads have a 3:1 safety factor at 120°F. Insulation may be required at higher temperatures. Tolerance is 3/4" maximum. For Celvis Hangers sizes 8" to 24" please contact us for pricing and availability.

FRP/GRP Channel Nut

Part No.	Size	Weight	t
CN-025	1/4"-20	5.58 Lbs/C	1 1/16" (27)
CN-038	3/8"-16	5.31 Lbs/C	1 1/16" (27)
CN-050	1/2"-13	5.27 Lbs/C	1 1/16" (27)

Vinyl Ester resin is the standard. Channel nuts are self locking and designed for use with EC-158 and EC-158D strut only.
Resistance to slip = 450 Lbs. per bolt
Pull out strength = 700 Lbs. per bolt
Recommended safety factor = 3

Non-Metallic Universal Pipe Clamp

Conduit Outside Diameter Inches
(for reference only)

Part No.	Pipe Size Inches	Wt./ 100 Sets* Lbs.	PVC Schedule 40 & 80	PVC Coated Steel	Rigid Steel	Fiberglass (FRP/GRP)
PC-1609N	1/2	9.0	0.840	0.920	0.840	-
PC-1610N	3/4	10.0	1.050	1.130	1.050	0.890
PC-1611N	1	10.5	1.315	1.395	1.315	1.195
PC-1612N	1 1/4	11.0	1.660	1.740	1.660	1.507
PC-1613N	1 1/2	13.0	1.900	1.980	1.900	1.757
PC-1614N	2	14.0	2.375	2.455	2.375	2.132
PC-1615N	2 1/2	18.0	2.875	2.955	2.875	2.650
PC-1616N	3	20.0	3.500	3.580	3.500	3.132
PC-1617N	3 1/2	23.0	4.000	4.080	4.000	3.632
PC-1618N	4	25.0	4.500	4.580	4.500	4.132

* Includes nylon bolt

For rigid, PVC coated steel, PVC Schedule 40 & 80 and fiberglass conduit.

Made from a toughened grade of glass reinforced polycarbonate resin. Standard fasteners are nylon slotted hex bolt and nut. Recommended for horizontal use as shown. For vertical placement please contact us.

Packaged 10 sets per bag.

If stainless steel fasteners are preferred, indicate by adding the letter "S" after the catalog number (Example: PC-1609S).

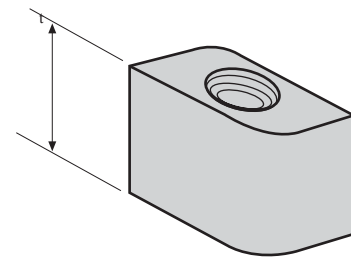
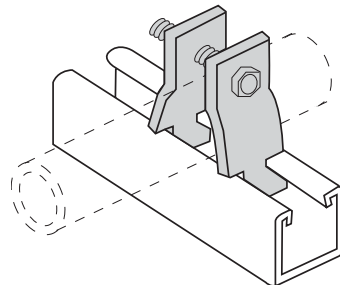
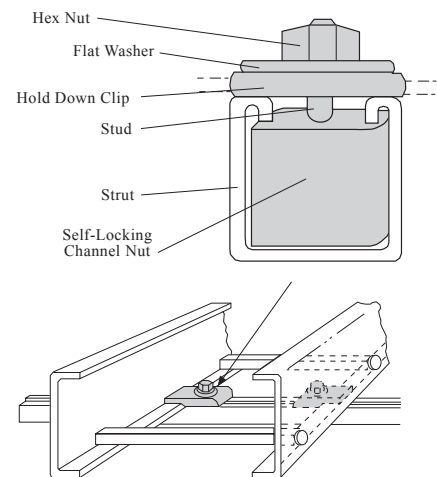

Diagram: FRP/GRP Channel Nut with Hold Down Clip



Typical Installations - Support Systems & Strut

Enduro's DuroStrut combined with our cable tray accessories are functional in many non-cable tray applications. DuroStrut includes all the items necessary to field fabricate to your specifications whether wall, floor, or ceiling mounted. Enduro can also assist in engineering to your requirements. The information published are guideline suggestions for the design professional. Full-scale proof testing of installation is recommended to verify assembly at site. If you need a special shape or assembly, call Enduro for information on custom pultrusions and fabrications.

Pipe Support Racks Sample Installation

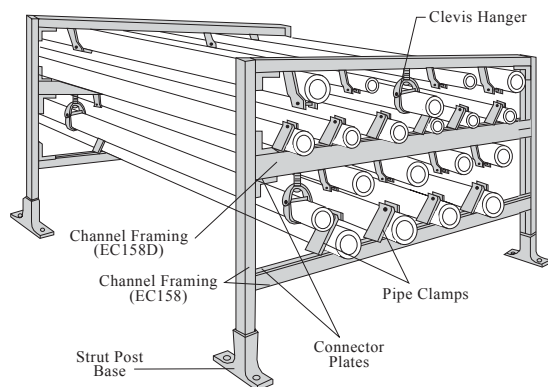

Wall Stanchion Sample Installation

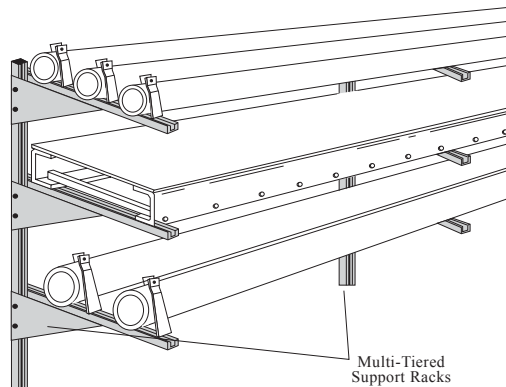

FRP Structural Shapes and Flat Sheets

Channel		Unusual Channel		Angle		Square Tube		Flat Sheet (Construction Grade)	
Size in Inches	Lbs/Ft	Size in Inches	Lbs/Ft	Size in Inches	Lbs/Ft	Size in Inches	Lbs/Ft	Size in Inches	Lbs/Ft
2 x 1 x 3/16	0.37	4 3/4 x 3 1/4 x 1/4	2.06	1 x 1 x 1/4	0.17	2 x 2 x 1/8	0.90	1/8 thickness	1.41
3 x 1 x 3/16	0.68	6 7/8 x 5 3/8 x 1/4	3.08	2 x 2 x 1/4	0.69	2 x 2 x 1/4	1.40	3/16 thickness	1.71
4 x 1 1/8 x 1/4	1.13	Round Tube		3 x 3 x 3/8	1.53	2 x 2 1/2 x 1/4*	1.55	1/4 thickness	2.34
6 x 1 5/8 x 1/4	1.70	2 3/8 x 1/4	1.45	4 x 4 x 3/8	2.09	2 1/2 x 2 1/2 x 1/4	1.70	3/8 thickness	3.35
6 x 1 5/8 x 5/16	2.10	Wide Flange Beam		4 5/8 x 1 5/8 x 1/8	0.83	3 x 3 x 1/4	2.20	1/2 thickness	4.03
6 x 2 x 3/16	1.53	6 x 6 x 3/8	5.30	5 x 5 x 3/8	2.81	3 x 4 x 1/4	2.51		
8 x 1 3/4 x 5/16	2.50			6 x 6 x 3/8	3.35	4 x 4 x 1/4	3.25		
10 x 2 3/4 x 3/8	4.27					6 x 6 x 1/4	4.70		

*Non stock item, minimum run required.

All are available in polyester and vinyl ester. Stocking lengths are 10' or 20' Flat sheet is available in 3' x 10' pieces. Contact us for required shapes not listed.

Specification - DuroStrut

1.0 Scope

1.1 This specification covers the requirements for Enduro non-metallic Channel Framing Systems & Accessories

2.0 Standards

- 2.1 All channel shall have a flame spread rating of 25 or less, and the Smoke Developed Index shall have a density of 450 or less when tested in accordance with the provisions of ASTM E-84; therefore qualifying as a class 1 material in the Uniform Building Code
- 2.2 All channel shall have a surfacing veil over the entire surface in addition to a UV inhibitor in the resin system to protect against degradation from ultra-violet light.
- 2.3 Glass-reinforced channels covered in this specification shall comply with the requirements of ASTM D 3917 and ASTM D 4385 which govern the dimensional tolerance and visual defects of pultruded shapes.

3.0 Materials

- 3.1 FRP channel shall be of pultruded glass-reinforced isophthalic polyester or vinyl ester resin having the physical property values listed in this catalog.
- 3.2 Some accessories shall be of injection molded, 40% long glass fiber reinforced polyurethane, or nylon.

- 3.3 All channel shall be manufactured by the pultrusion process, and contain a minimum of 50% glass by weight.
- 3.4 All channel shall conform, as a minimum requirement, to loads and deflections shown on the tables in the latest version of the Enduro technical catalog.

4.0 Non-Metallic Pipe Clamps

- 4.1 All pipe clamps shall be manufactured by the injection molding process with an impact modified, 30% glass filled thermoplastic polyester resin.
- 4.2 All pipe clamps interlock with the channel framing described above.
- 4.3 All pipe clamps shall be designed for rigid PVC coated steel, Schedule 40 and 80 PVC, and filament wound fiberglass pipe or conduit. Clamps shall be adjustable to accommodate a 3/4" minimum deviation in O.D. size.

5.0 Fasteners

- 5.1 All fasteners shall be injected molded glass reinforced nylon, 316 stainless steel, or pultruded vinyl ester rod with ground threads and compression molded vinyl ester nuts.

6.0 Acceptable Manufacturer

- 6.1 DuroStrut is manufactured and fabricated exclusively by Enduro Composites, Inc. - Houston, TX.

Fastener & Hanging Systems

Enduro fastener and hanging systems are exceptionally strong non-metallic mechanical systems with outstanding shear and tensile strengths. This makes the Enduro fastener system an excellent choice for all structural, mechanical and electrical applications where fasteners must be corrosion-resistant and/or non-conductive. It is not recommended that FRP/GRP threaded rod be used in conjunction with steel or PVC coated steel beam clamps or nuts. Thread shear could occur due to insufficient thread engagement.

FRP/GRP Threaded Rod

Part No.	Size	Weight
TR-FRP-038	3/8"-16	0.07 Lbs/Ft
TR-FRP-050	1/2"-13	0.12 Lbs/Ft
TR-FRP-0625	5/8"-11	0.18 Lbs/Ft
TR-FRP-075	3/4"-10	0.28 Lbs/Ft
TR-FRP-100	1"-8	0.50 Lbs/Ft



Hex Nut

Part No.	Thread Size	Height	AF	AC
FN-038	3/8"-16	.337-.320"	.563-.551"	.650-.628"
FN-050	1/2"-13	.448-.427"	.750-.736"	.866-.84"
FN-0625	5/8"-11	.559-.535"	.938-.922"	1.083-1.051"
FN-075	3/4"-10	.665-.617"	1.125-1.088"	1.299-1.24"
FN-1000	1"-8	.887-.831"	1.5-1.45"	1.732-1.653"

FRP/GRP Flat Washer

Part No.	Size	Weight
FW-FRP-038	3/8"-16	1.3 Lbs/C
FW-FRP-050	1/2"-13	1.3 Lbs/C
FW-FRP-0625	5/8"-11	1.3 Lbs/C
FW-FRP-075	3/4"-10	1.3 Lbs/C
FW-FRP-1000	1"-8	1.3 Lbs/C

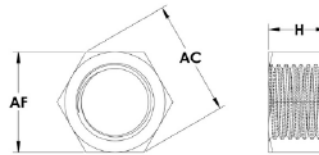
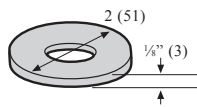

FRP/GRP Rod Coupler

Part No.	Size	Weight	t
RC-FRP-038	3/8"-16	7.80 Lbs/C	2" (51)
RC-FRP-050	1/2"-13	7.00 Lbs/C	2" (51)
RC-FRP-0625	5/8"-11	13.73 Lbs/C	2" (51)
RC-FRP-075	3/4"-10	12.66 Lbs/C	2" (51)
RC-FRP-1000	1"-8	44.03 Lbs/C	2 3/4" (70)

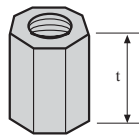

Vinyl Ester resin is the standard.
IMPORTANT: Minimum thread engagement must be 3/4" per side.

Beam Clamps

Part No.	Description
BCS-3/8	Single for 3/8" FRP/GRP Threaded Rod
BCS-1/2	Single for 1/2" FRP/GRP Threaded Rod
BCS-3/8	Double for 3/8" FRP/GRP Threaded Rod
BCS-1/2	Double for 1/2" FRP/GRP Threaded Rod

Ultimate load = 300 Lbs. Recommended safety factor = 3
SS set screws included with clamps.



Typical Properties - FRP/GRP Threaded Rod

Properties	3/8-16 UNC	1/2-13 UNC	5/8-11 UNC	3/4-10 UNC	1-8 UNC
Thread shear strength using FRP/GRP hex nut in tensile - Lbs.	1,250	2,200	3,100	4,500	6,500
Transverse shear on threaded rod - double shear (load Lb.) (ASTM-B565)	3,000	5,000	7,500	12,000	22,000
Transverse shear on threaded rod - single shear (load Lb.)	1,600	2,600	3,800	6,200	15,000
Compressive strength longitudinal, PSI (ASTM-D695)	54,000	54,000	54,000	54,000	65,000
Flexural strength, PSI (ASTM-D790)	55,000	55,000	55,000	55,000	60,000
Flexural modulus, PSI x 10 ⁶ (ASTM-D790)	2.0	2.0	2.0	2.50	2.75
Torque strength using fiberglass nut lubricated with SAE 10W30 motor oil, Ft.-Lbs.	8	18	35	50	110
Dielectric strength, KV/In. (ASTM-D149)	35	35	35	35	35
Water absorption 24 hour immersion - threaded, % (ASTM-D570)	1	1	1	1	1
Coefficient of thermal expansion - longitudinal In./In./°F	5 x 10 ⁻⁶	5 x 10 ⁻⁶	5 x 10 ⁻⁶	5 x 10 ⁻⁶	5 x 10 ⁻⁶
Max recommended operation temp - based on 50% retention of ultimate thread shear strength °F (°C)	200°(93°)	200°(93°)	200°(93°)	200°(93°)	200°(93°)
Stud weight, Lb./Ft.	0.07	0.12	0.18	0.28	0.50
Flammability	Self-extinguishing on all				

Note: 1 Ft.-Lb. = .138 kg-M; 1 Lb = .4536 kg; 1 PSI = 6.984 K Pa; Test results are for studs with single FRP/GRP hex nuts only, stainless steel nuts will result in reduced values. Proper safety factors should be applied to testing. All values are based on laboratory test results.

Fastener & Hanging Systems - Installation Guide

The Enduro fastener system is a vinyl ester resin and fiberglass composite with unique characteristics which make it ideal for many applications where high strength, non-metallic fasteners are required.

For Access After Installation

If the assembly will require occasional removal of the nuts, the rod should be lightly coated with a dry lubricant, silicon spray, or a light oil prior to assembly.

For Permanent Installation

If the assembly is designed to be a permanent installation, the nuts and studs should be bonded with an epoxy adhesive.

Apply a light coating of adhesive to the stud and nut threads, then quickly secure the assembly before adhesive has time to set, otherwise the mil thickness of the adhesive will make it impossible to thread. Next, apply a thick coat of adhesive to the exposed stud and nut surfaces. This provides a locking mechanism which eliminates the need for extra torque and lock washers.

For Hanging System Installation

The optimum method of installation for a hanger system is to finger tighten the assembly and then only tighten the nuts one-half turn to secure any jam nut assemblies. Follow the permanent installation procedure whenever possible. This results in minimum torque and allows maximum thread shear.

To insure maximum resistance to chemical attack once the assembly is completed, the exposed stud thread and nut surfaces should be coated with Enduro's Field Cutting Sealant (Part No. ES-Q or ES-G). Please contact Enduro for pricing.

Metal & FRP/GRP Installation

When utilizing metal fasteners, connectors, or nuts, consideration must be given to reduced strengths. Enduro rod and nuts are designed with maximum thread engagement and extra nut thickness. Metal products have less thread engagement. When installation requires metal components, special tests may be necessary to define ultimate strengths of the fastener systems.

For Beam Clamp Installation

Maximum installation torque of 10 foot-pounds is recommended to secure set screw.

Site Conditions

Vibration and dynamic loading conditions on the Enduro fastener assembly should be eliminated or minimized. If this is not possible, additional safety factors should be used in designed the fastener system.

Tools Required

The oversize hex nut design of the Enduro nut requires a larger than normal socket wrench, but either a six point or twelve point socket will work.

Important - do not exceed the torque values listed in the table above.

Caution

Do not over torque the Enduro nut and rod. The thread shear and torque values are NOT mutually exclusive, they are additive

Example

1/2" - 13 has a thread shear of 2,200 Lbs. and an ultimate torque strength of 18 ft-lbs. If you use the maximum installation torque of 8 ft-lbs, the amount of thread shear remaining is reduced to 1,225 lbs.

Specifying engineers should apply this information at the design stage, applying the proper safety factors to ensure a secure installation.

Typical Hanging Support System

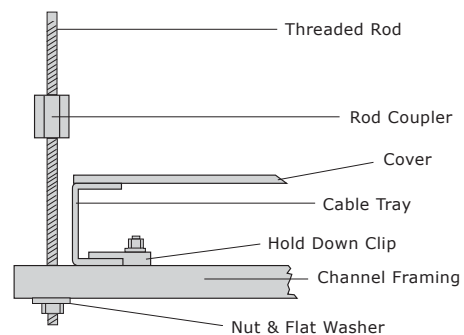

Instrument & Pushbutton Stands

Enduro's universal instrument support system offers many of the same features and benefits as our cable tray, strut and wireway systems. Enduro instrument and pushbutton stands are built to any configuration required, including, single or double post, large mounting panel (switch rack/station) type designs, and any mounting requirements needed. For all configurations, please specify dimensions in inches.

Enduro Instrument & Pushbutton Stand Benefits:

- Costs less than stainless steel systems & competitive with most metallic systems
- Faster assembly time than metallic systems due to easy cut, fit, and adhesive design
- Lighter weight with corrosion resistance comparable to stainless steel and galvanized stand designs
- Compatible with metallic post bases and metallic support structures
- Easily built on site allowing for design freedom and increasing response time
- Constructed from 2" Schedule 80 gray vinyl ester base for superior corrosion resistance
- 2" SteelFree™ U-Bolt (shown below) may be used to attach instruments and/or gauges to the supports

Floor Mount Single

Part No. Key*

DISR170B1 x (A)

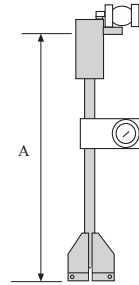

Column or Wall Mount

Part No. Key*

DISR175B48 x (A) x (B)

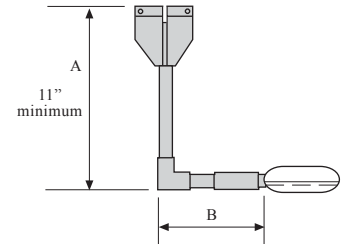

Floor Mount, Multiple Instruments

Part No. Key*

DISR172B - (A) x (B) x (C)

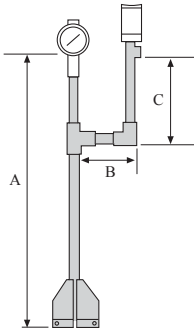

Floor Mount Double

Part No. Key*

DISR171B - (A) x (B) x (C)

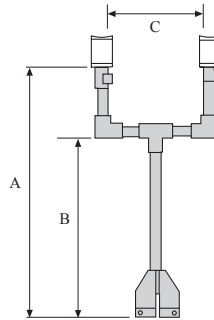

Floor Mount Triple

Part No. Key*

DISR173T - (A) x (B) x (C) x (D)

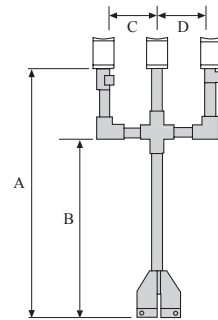

Pushbutton Station

Part No. Key*

DPS - (A) x (B) x (C)

Made of pultruded fiberglass reinforced vinyl ester 2" square tube with an 8" square vinyl ester base at 6 1/2" high. Please specify dimensions in inches.

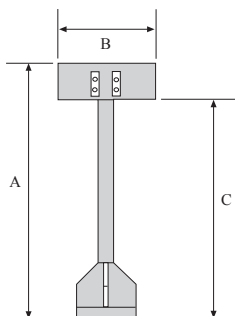

U-Bolts

Part No.	Pipe Nom. Dia.	A	B	C	D	TL	Max Rec. Loading Lbs.	Max Rec. Torque In.-Lbs.
EU050	1/2"	0.93	0.375	1.56	2.41	1.25	75	20
EU070	3/4"	1.12	0.375	1.66	2.60	1.25	75	20
EU100	1"	1.37	0.375	1.78	2.85	1.25	75	20
EU125	1 1/4"	1.68	0.375	1.94	3.16	1.25	75	20
EU150	1 1/2"	2.00	0.375	2.10	3.47	1.25	75	20
EU200	2"	2.43	0.500	2.46	4.18	1.50	150	40
EU250	2 1/2"	2.93	0.500	2.71	4.68	1.50	150	40
EU300	3"	3.56	0.500	3.03	5.31	1.50	150	40
EU350	3 1/2"	4.06	0.500	3.28	5.81	1.50	150	40
EU400	4"	4.56	0.500	3.53	6.31	1.50	150	40

Made from glass reinforced polyurethane resin, u-bolts are the ideal choice for mounting enclosures, instrumentation, conduit, and piping on your Enduro instrument and pushbutton support systems. Excellent as an alternative when replacing corroded steel u-bolts. Recommended for operating temperatures up to 150 °F. Four nuts included with each u-bolt.

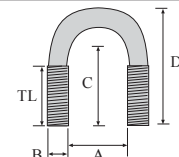

* In Part No. Key, parentheses () = insert corresponding dimension

composites
enduro

**I
S
O 9001:2015
CERTIFIED**

www.endurocomposites.com

sales@endurocomposites.com

HOUSTON

16602 Central Green Blvd.

Houston, TX 77032

800.231.7271

SAUDI ARABIA

P.O. Box 4779 Al-Khobar 31952

Kingdom of Saudi Arabia

966.3.8128630